



INSTALL LINE

Powersoft

INSTALL-DEDICATED AMPLIFIER PLATFORMS.

DESIGNED TO ALWAYS FIT IN.

Designed to always fit in, Powersoft's range of install-dedicated amplifier platforms caters to all system sizes.

Whether renewing an obsolete system or creating a new one, Powersoft's patented designs allow for flawless integration within existing structures, and for great value in long run saving strategies.

An extensive distributor and service network guarantees the support needed for such installations, whilst our Engineering Tools will make choosing the right Powersoft Amplifier Platform a breeze.



GREEN AUDIO POWER

AUDIO NETWORK

At Powersoft we take pride in our commitment to produce in a more sustainable way and in delivering more efficient products by exploiting the full potential of Class D amplification. The **PFC** technology grants extremely high efficiency values: our install line amplifier platforms transform all the energy drawn from the mains into usable power.

The **Pulse Width Modulation Output Stage** recycles the reactive energy coming back from the loudspeakers. Without compromising sound quality, the implementation of this technologies enhances the listener's experience, whilst helping to preserve the beauty of our planet.

Our high-performance amplifier platforms seamlessly integrate within networking environments.

Basic remote control is available in non DSP models through **ArmoniaPlus™**, whilst comprehensive remote control is available in DSP+D versions.

DPS+D versions are equipped with **Dante™** inputs, offering an even wider range of compatibility, monitoring and sound shaping capabilities. The whole line may be controlled by third party applications both in wired networks and through WiFi. Full flexibility in control is granted by **Operator View** via any remote device.



SAFETY AND RELIABILITY

AUDIO QUALITY

Picture by Wonho Frank Lee

Our Install Line Amplifier Platforms can be trusted in the most demanding situations.

By exploiting the **GPI/O** port it is possible to implement our products in mission-critical applications, such as alarm systems.

Some safety features include:

- Redundant Power Supply (Ottocanali).
- Live Impedance Monitoring.
- Pilot tone Monitoring.
- 5 Independent Limiter types.
- Fold Back Audio Routing.
- Input and Output Monitoring.

Powersoft's renowned sound quality has its roots in the experience matured in more than 20 years of being at the forefront of the **Class D Revolution**.

Our refined DSP has outstanding digital sound processing capabilities allowing the engineer to tailor the sound to specific needs.

By recycling the otherwise wasted reactive energy gathered from the transducer and actively controlling the **Damping Factor**, our amplifier platform delivers crisp highs and rounded, full lows even at low levels.



QUEEN ELIZABETH HALL, BELGIUM

CHALLENGE

Design of speech and music system for concert hall and 10 congress venues.

SOLUTION

6x **Ottocanali** Powersoft amplifier platforms with internal **DSP** and **Dante™** on board to drive the main speaker and monitor sets. Matrix and processing are all solved with the amplifiers, eliminating the need for external DSPs. Everything is configured with the ArmoniaPlus software.

RESULT

A system with full remote control and local DSP assigned to Powersoft amplifiers. Full **Dante™** audio distribution and audio Matrix on board of the amplifiers. A very capable set-up operated with a very user-friendly interface.

MEZZO A/AD SERIES

2/4 CHANNEL COMPACT INSTALL AMPLIFIER

The same sound clarity, reliability, and overall build quality of any Powersoft install dedicated amplifier platform in a ½ rack unit. It comes in 2 power supply sizes, 2 or 4 channels, and state of the art DSP. The AD versions add Dante™, an internal Gigabit Ethernet switch and a second port so that multiple products can share the same network cable.

KEY FEATURES

- **All round performer**
Mount Mezzo anywhere and power any speaker configuration
- **System simplifier**
Reduce the number of devices and media dependency in any system
- **All encompassing**
Adapts to multiple uses and applications through flexible power routing
- **Self adjusting**
Straightforward, automatic configuration at the push of a button
- **Networked**
Build centralized and decentralized, connected systems
- **Clever form factor**
Mix and match to the exact requirement, fit 2 in a single rack unit



Armonia+Plus
System Manager



PRODUCT RANGE

MODEL	2Ω	4Ω	8Ω	70/100 V
322 A/AD	160 W	160 W	160 W	160 W
602 A/AD	200 W	300 W	300 W	300/250 W
324 A/AD	80 W	80 W	80 W	80 W
604 A/AD	150 W	150 W	150 W	150/125 W

ULTIMATE FLEXIBILITY

INSTALL MEZZO ANYWHERE WITH THE INCLUDED MOUNTING KIT

The included mounting accessories allow multiple mounting configurations: 1 or 2 units in a 19" Rack, 1 unit in an 11" Rack, wall/ceiling. Rubber feet are also included to use Mezzo as a standalone unit. Mezzo is extremely thin and can easily fit behind wall mounted screens, and the 320W are sealed designs, and approved for hidden placement.

MOUNTING ACCESSORIES



Rack ears and wall/ceiling mounts

MOUNTING OPTIONS

Standalone



11" Rack



19" Rack - 1 Unit



19" Rack - 2 Units

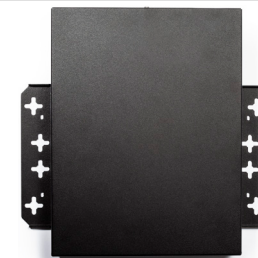

Wall/Ceiling mount (the brackets can also be rotated so that they are hidden behind the amplifier for a cleaner look)



RIXOS PREMIUM HOTEL - DUBAI

CHALLENGE

Deliver world-class audio experience to 5 venues within the hotel

SOLUTION

A multitude of Duecanali, Quattrocanali, Ottocanali amplifier platforms work together and are controlled through ArmoniaPlus.

RESULT

A system that is able to adapt to the different types of events held in the hotel, that offers the ultimate flexibility in signal routing.

DUECANALI SERIES

2-CHANNEL AMPLIFIER PLATFORM FOR INSTALLED SOUND REINFORCEMENT SYSTEMS.

The brand new Duecanali Series shines with outstandingly low power consumption and heat dissipation, with direct positive effects on investment. It is aimed at larger two-channel install applications and it is able to provide more than 16 different possible output configurations including Lo-Z, Hi-Z, bridge mode, and parallel mode.

KEY FEATURES

- Universal Main, PFC, Smart Rails Management
- GPI For external VCA volume control
- DIP Switch for 70/100V- Low-Z Selection
- Ethernet control for 3rd-Party Control Systems
- Diagnostics GPO Alarms
- Adjustable Gain (26-35 dB)
- Optional DSP + Dante™ versions



Armonía-Plus System Manager



PRODUCT RANGE

MODEL	2Ω	4Ω	8Ω	70/100 V
804	500 W	400 W	400 W	400 W
1604	1000 W	800 W	800 W	800 W
4804	3000 W	2400 W	1250 W	2400 W
6404	4600 W	3200 W	1800 W	3200/4000 W

TAILORED CONFIGURATION

COMBINED SOLUTIONS WITH 2-CHANNEL AND 4-CHANNEL AMPLIFIER PLATFORMS.

A system built around Dante™ enabled Duecanali and Quattrocanali Series amplifier platforms meets and exceeds all requirements in terms of flexibility, controllability, and scalability. Any mixed output configuration is possible, allowing for multi-zone sound distribution, with the matrix function in ArmoníaPlus granting total control over each signal.

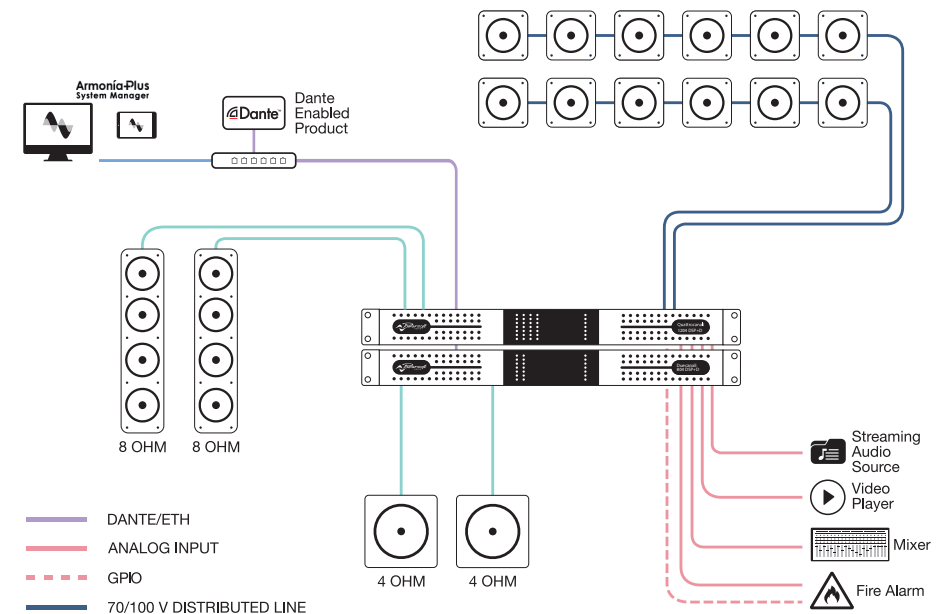

QUATTROCANALI SERIES

4-CHANNEL AMPLIFIER PLATFORM CATERING TO ALL SMALL TO MEDIUM APPLICATIONS.

The Quattrocanali series is made up of three models: 4804, 2404, and 1204, and it addresses the requirements from small and medium applications where the channel count is limited but the need of a flexible product to work with Hi-Z and Lo-Z systems is a must. In just 1 RU, Quattrocanali offers smaller dimensions, lighter weight and the traditionally amazing sound quality and reliability of all Powersoft products.

KEY FEATURES

- Universal Main, PFC, Smart Rails Management
- GPI For external VCA volume control
- DIP Switch for 70/100V- Low-Z Selection
- Ethernet control for 3rd-Party Control Systems
- Diagnostics GPO Alarms
- Adjustable Gain (26-35 dB)
- Optional DSP + Dante™ versions

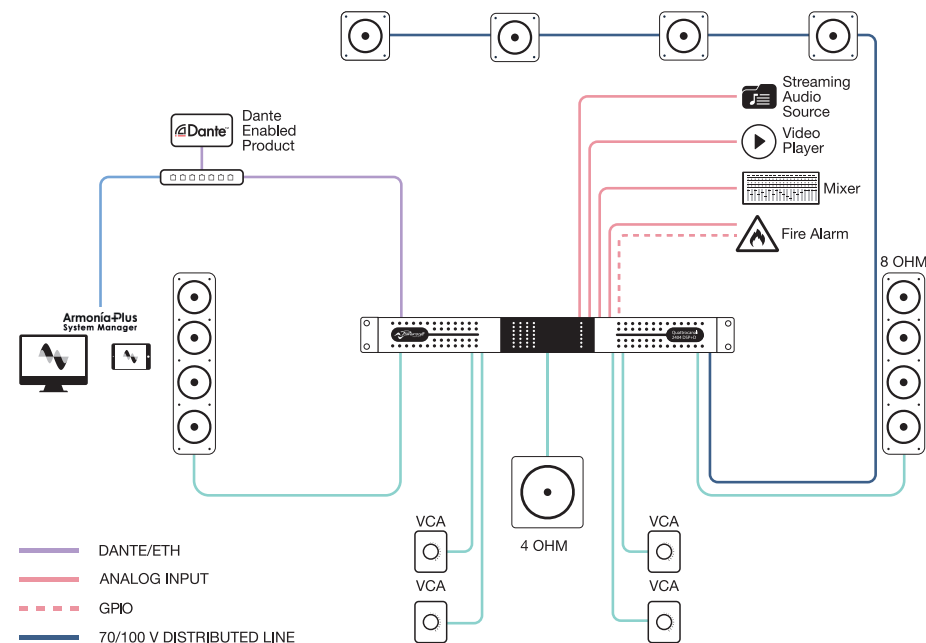

Armonia-Plus System Manager



PRODUCT RANGE

MODEL	2Ω	4Ω	8Ω	70/100 V
1204	400 W	300 W	300 W	300 W
2404	800 W	600 W	600 W	600 W
4804	1500 W	1200 W	1200 W	1200 W
8804	1800 W	2400 W	1600 W	2000 W

STANDARD VERSION

- 4 GPI
- 4 GPO
- ArmoniaPlus™
- Level Control & Mutes
- Groups

DSP+D

- 4 GPI
- 4 GPO
- ArmoniaPlus™
- Level Control & Mutes
- Groups
- Full DSP Functions Included
- Dante™ Integration

DINOSAURS IN THE WILD

CHALLENGE

Creating a dependable installation capable of delivering a truly immersible experience.

SOLUTION

35 **Quattrocanali 1204 DSP+D** amplifiers integrated within a Dante™ Network.

RESULT

An extremely complex yet believable 3d sound experience featuring outstanding levels of detail.

OTTOCANALI SERIES

8-CHANNEL POWER AMPLIFIERS FOR MISSION CRITICAL APPLICATIONS.

The Ottocanali is a flexible and reliable 8-channel power amplifier with up to a total of 12,000 W at 4Ω, ideal for multi-zone applications in medium to large-scale installations: Ottocanali Series supports any combination of Lo-Z loudspeakers, mono-bridgeable channel pairs and 70V/100V Hi-Z distributed lines with no need for output step-up transformers.

KEY FEATURES

- Universal switch mode power supply up to 400VAC tolerant with PFC
- Fully protected circuit design
- Standard Phoenix connectors: analog inputs, audio outputs, aux supply, alarms and GPIO
- Remotely switchable inputs (main and aux)
- Optional DSP+Dante™ version



**Armonía-Plus
System Manager**



PRODUCT RANGE

MODEL	2Ω	4Ω	8Ω	70/100 V
12K4	1000 W	1500 W	850 W	1500 W
8K4	850 W	1000 W	600 W	1000 W
4K4	450 W	500 W	250 W	500 W

OTTOCANALI 1204 SERIES

8-CHANNEL POWER AMPLIFIER FOR LO-Z AND HI-Z TRANSDUCERS.

The Ottocanali 1204 offers unprecedented versatility and efficiency, also thanks to its very own set of BatFormers®. These are specifically developed, optional plug-in output transformers that can be easily installed through a dedicated lid in the amplifier chassis, and that allows the conversion of any- or all- of the 8 channels into a 70V or 100V constant voltage output.

KEY FEATURES

- Universal switch mode power supply up to 400VAC tolerant with PFC
- Fully protected circuit design
- Light weight: 5-11 kg (11-24.3 lbs) depending on number of BatFormers
- Standard Phoenix connectors: analog inputs, audio outputs, aux supply, alarms and GPIO
- Remotely switchable inputs (main and aux)
- Optional BatFormer™ plug-in output transformers for 70/100V installations
- Optional DSP+ETH version



**Armonía-Plus
System Manager**



PRODUCT RANGE

MODEL	4Ω	8Ω	70 V	100 V
1204	150 W	80 W	125 W	130 W

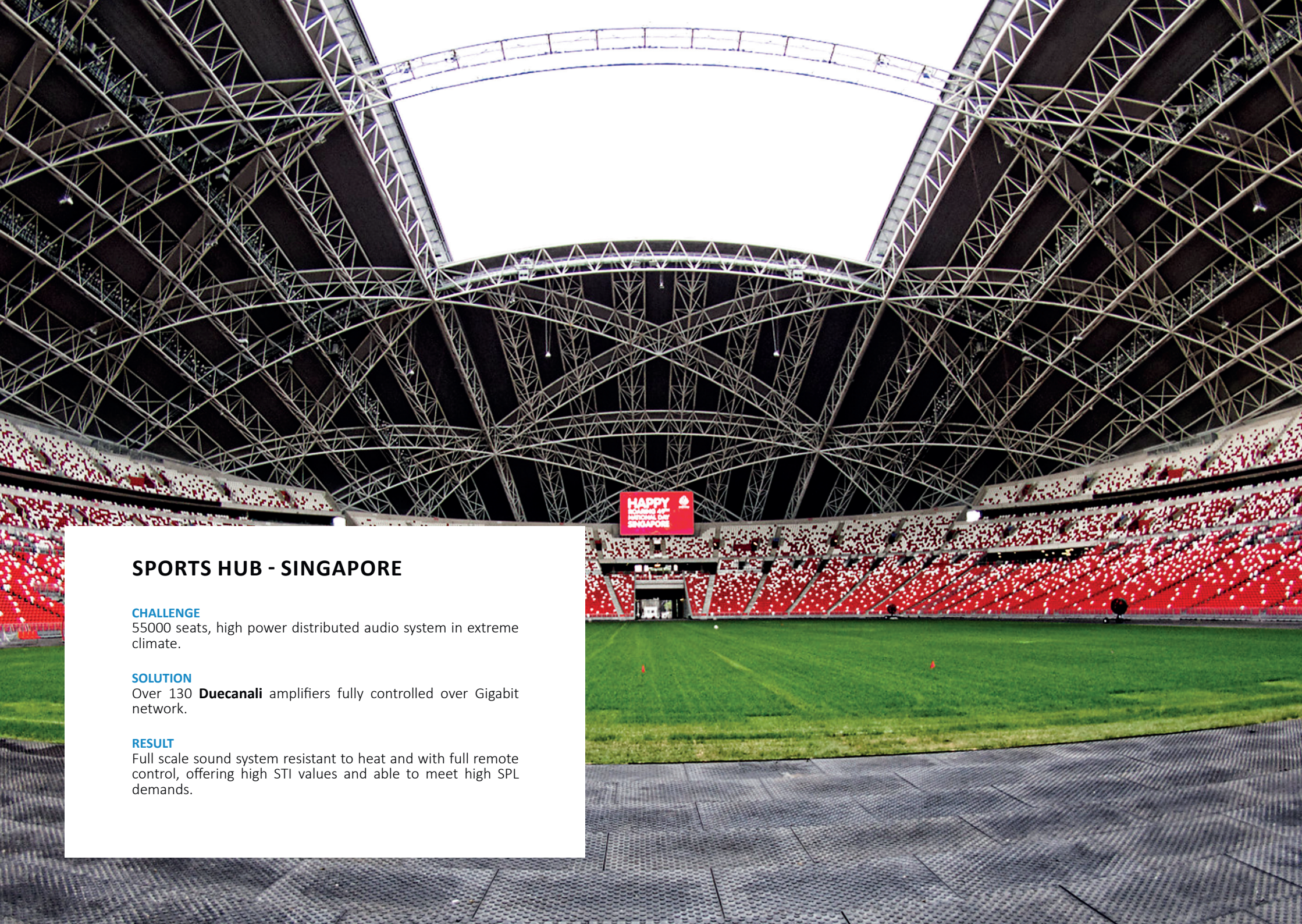

SPORTS HUB - SINGAPORE

CHALLENGE

55000 seats, high power distributed audio system in extreme climate.

SOLUTION

Over 130 **Duecanali** amplifiers fully controlled over Gigabit network.

RESULT

Full scale sound system resistant to heat and with full remote control, offering high STI values and able to meet high SPL demands.

ArmoníaPlus System Manager

REMOTE CONTROL AND MONITORING OF THE FULL RANGE OF POWERSOFT PRODUCTS.

Setting up and managing complex sound systems easily through a highly intuitive user interface has become more than a popular demand- it's reality.

ArmoníaPlus has raised the bar by offering an intuitive interface for parameters adjustment, a comprehensive control over the digital audio processing and complete real-time monitoring of the system's performances, making your system safer and better sounding, especially in combination with Powersoft DSP technology.

With ArmoníaPlus, audio engineers have new and unique tools to significantly improve sonic performance and system reliability.

KEY FEATURES

- ArmoníaPlus works with the full range of Powersoft products
- ArmoníaPlus provides total system and sound control in real-time
- Improved EQ visualization with automatic frequency-reordered filters
- Output EQs, delays, and a highly sophisticated group limiters
- Input EQ in three layers with hundreds of filters for individual tuning
- Ultimate protection: RMS, Peak, Click, True Power, and Current
- Access Manager allows three access levels
- Complete integration with FIR Maker (FIR custom filters)
- Fully integrated with Rational Acoustic Smaart v8
- Supported languages: English, Italian, Spanish, Portuguese, Chinese, and Japanese

INTERACTIVE TUNING

ArmoníaPlus is now fully integrated with Rational Acoustic Smaart v8, able to read real-time, imported, or shared location traces. Tuning a system has never been so fast and easy.

OPERATOR VIEW







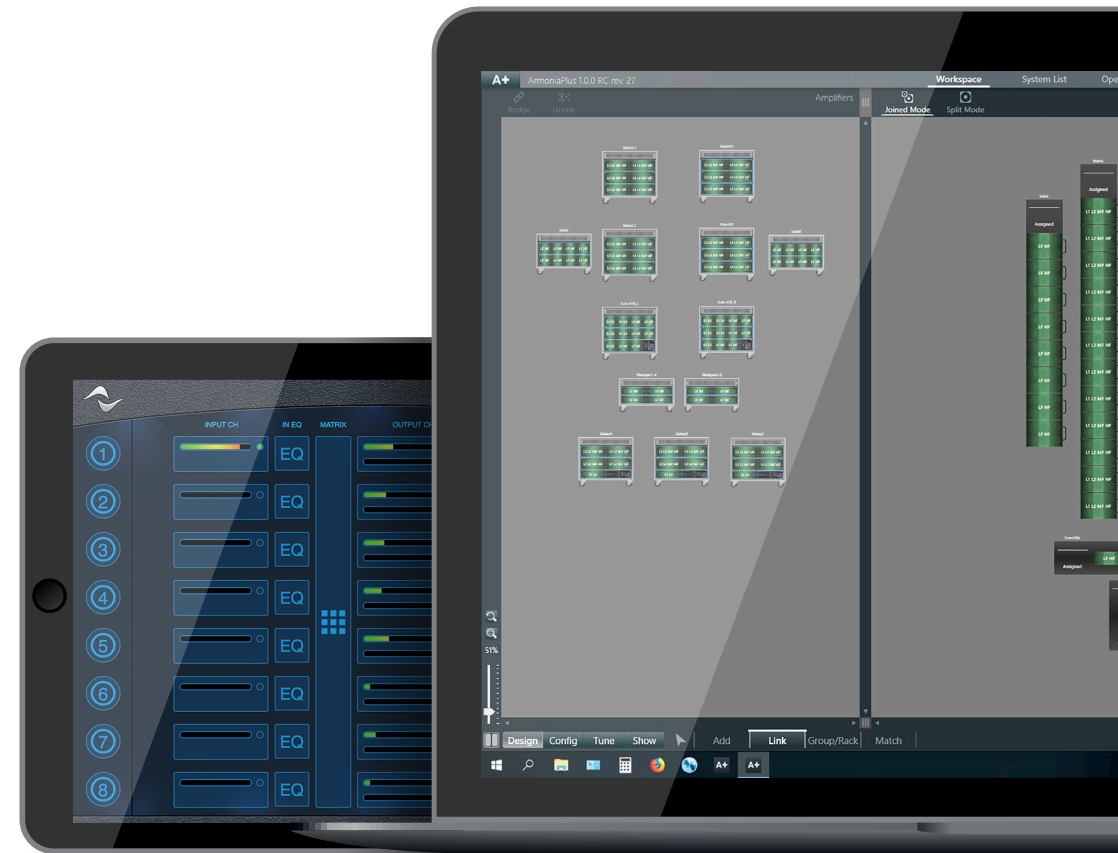





Used in conjunction with the Access Manager, the Operator View enables the system administrator to tailor access credentials and limit functionality.

WEBAPP

The Webapp makes our install dedicated amplifier platforms remotely accessible and operable.

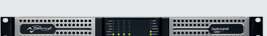
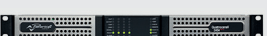

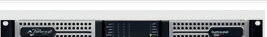
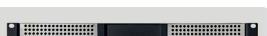
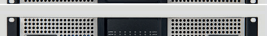
TECHNICAL SPECIFICATIONS CHART

		POWER @ 2Ω	POWER @ 4Ω	POWER @ 8Ω	BRIDGED @ 4Ω	BRIDGED @ 8Ω	70 V	100 V	MAX OUTPUT VOLTAGE @ LO-Z	MAX OUTPUT CURRENT @ LO-Z	CURRENT DRAW* 115 V	230 V	IDLE POWER STD DSP+D	THERMAL DISSIPATION*	S/N RATIO	DSP+DANTE™ OPTION AVAILAIBLE	
322 A/AD		160 W	160 W	160 W	UP TO 320 W***	UP TO 320 W***	UP TO 320 W***	UP TO 320 W***	142 V _{PEAK}	15.6 A _{PEAK}	0.8 A	0.4 A	14.0 W (A) 17.0 W (AD)	114 BTU/h	> 103 dBA	AD Version	
602 A/AD		200 W	300 W	300 W	UP TO 400 W***	UP TO 600 W***	UP TO 600 W***	UP TO 500 W***	142 V _{PEAK}	15.6 A _{PEAK}	1.2 A	0.6 A	14.0 W (A) 17.0 W (AD)	157 BTU/h	> 105 dBA	AD Version	
324 A/AD		80 W	80 W	80 W	UP TO 320 W***	UP TO 320 W***	UP TO 320 W***	UP TO 320 W***	142 V _{PEAK}	15.6 A _{PEAK}	0.8 A	0.4 A	18.0 W (A) 21.0 W (AD)	131 BTU/h	> 100 dBA	AD Version	
604 A/AD		150 W	150 W	150 W	UP TO 400 W***	UP TO 600 W***	UP TO 600 W***	UP TO 500 W***	142 V _{PEAK}	15.6 A _{PEAK}	1.3 A	0.6 A	18.0 W (A) 21.0 W (AD)	176 BTU/h	> 102 dBA	AD Version	
804		2 x 500 W	2 x 400 W	2 x 400 W	1 x 1000 W	1 x 800 W	2 x 400 W	2 x 400 W	80 V _{PEAK}	39 A _{PEAK}	1.4 A	0.9 A	24.7 W	23 W	161 BTU/h	> 106 dBA	Yes
1604		2 x 1000 W	2 x 800 W	2 x 800 W	1 x 2000 W	1 x 1600 W	2 x 800 W	2 x 800 W	115 V _{PEAK}	45 A _{PEAK}	2.5 A	1.5 A	25.5 W	23 W	251 BTU/h	> 109 dBA	Yes
4804		2 x 3000 W	2 x 2400 W	2 x 1250 W	1 x 6000 W	1 x 4800 W	2 x 2400 W	2 x 2400 W	142 V _{PEAK}	80 A _{PEAK}	7.0 A	3.9 A	31.1 W	32.5 W	528 BTU/h	> 111 dBA	Yes
6404		2 x 4600 W	2 x 3200 W	2 x 1800 W	1 x 9200 W	1 x 6400 W	2 x 3200 W	2 x 4000 W	175 V _{PEAK}	110 A _{PEAK}	10 A	5.3A	-	33 W	913 BTU/h	> 112 dBA	Only
1204		4 x 400 W	4 x 300 W	4 x 300 W	2 x 800 W	2 x 600 W	4 x 300 W	4 x 300 W	70 V _{PEAK}	33 A _{PEAK}	2.7 A	1.6 A	31.6 W	32.8 W	348 BTU/h	> 104 dBA	Yes
2404		4 x 800 W	4 x 600 W	4 x 600 W	2 x 1600 W	2 x 1200 W	4 x 600 W	4 x 600 W	100 V _{PEAK}	45 A _{PEAK}	4.2 A	2.4 A	31.6 W	31.8 W	471 BTU/h	> 108 dBA	Yes
4804		4 x 1500 W	4 x 1200 W	4 x 1200 W	2 x 3000 W	2 x 2400 W	4 x 1200 W	4 x 1200 W	139 V _{PEAK}	45 A _{PEAK}	9.1 A	5.0 A	32.4 W	33.7 W	768 BTU/h	> 110 dBA	Yes
8804		4 x 1800 W	4 x 2400 W	4 x 1600 W	2 x 3600 W	2 x 4800 W	4 x 2000 W	4 x 2000 W	175 V _{PEAK}	55 A _{PEAK}	15.6 A	8.2 A	-	34 W	1713 BTU/h	> 112 dBA	Only
4K4		8 x 450 W	8 x 500 W	8 x 250 W	4 x 900 W	4 x 1000 W	8 x 500 W	8 x 500 W	65 V _{PEAK}	15 A _{PEAK}	6.6 A	3.9 A	50 W	77 W	839 BTU/h	> 107 dBA	Yes
8K4		8 x 850 W	8 x 1000 W	8 x 600 W	4 x 1700 W	4 x 2000 W	8 x 1000 W	8 x 1000 W	90 V _{PEAK}	23 A _{PEAK}	12.6 A	6.6 A	50 W	77 W	1504 BTU/h	> 107 dBA	Yes
12K4		8 x 1000 W	8 x 1500 W	8 x 850 W	4 x 2200 W	4 x 3000 W	8 x 1500 W	8 x 1500 W	150 V _{PEAK}	54 A _{PEAK}	18.5 A	9.7 A	50 W	77 W	2141 BTU/h	> 109 dBA	Yes
1204		--	8 x 150 W	8 x 80 W	--	4 x 300 W	8 x 125 W**	8 x 130 W**	38 V _{PEAK}	15 A _{PEAK}	1.9 A	1.2 A	15.6 W	21.2 W**	252 BTU/h	> 105 dBA	No

*1/8 of max output power @ 4Ω

*** Mezzo can't be bridged but power sharing

** Requires the use of the BatFormers™

allows increased power per channel

Data subject to change without notice.



DRIVING HUMAN AUDIO EXPERIENCE

Powersoft S.p.A.

Via Enrico Conti, 5
Scandicci (Fi) 50018 - Italy

✉ powersoft@pec.it

☎ +39 055 73 50 230

☎ +39 055 73 56 235

POWERSOFT.COM