

Roland

VC-1 Series

VIDEO CONVERTERS

Lossless 3G-SDI and HDMI Conversion



HDMI to SDI
VC-1-HS

SDI to HDMI
VC-1-SH

FS Delay
VC-1-DL

3G bps
1080/60p

Lossless

HDCP

AUDIO EMBEDDING

Lossless conversion in the palm of your hand.

Awarding-winning multi-format conversion technology concentrated in a simplified mini-converter.

Uncompromising commitment to picture quality.

The VC-1 series faithfully converts the original source with no change in color or brightness. It supports super-blacks and super-whites, and converts video from cameras and other source devices with all the originality intact.

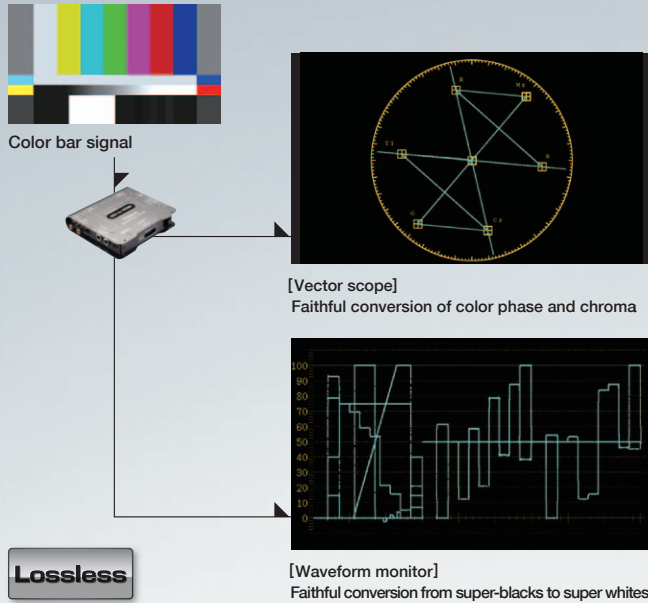

On-board reclocker.

The VC-1 series features an on-board reclocker to compensate for attenuation of SDI signals carried over long distances. This makes it possible to receive camera-relay video while maintaining a high image quality.

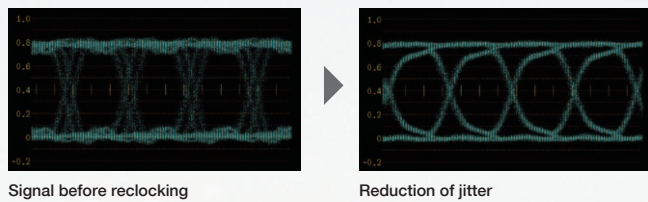

Faithful reproduction of video characteristics.

The VC-1 series reproduces the video characteristics of the original source with no interlace artifacts, pixel shifting, or other conversion problems or signal errors. Jitter and return loss are at exceptional levels as well.

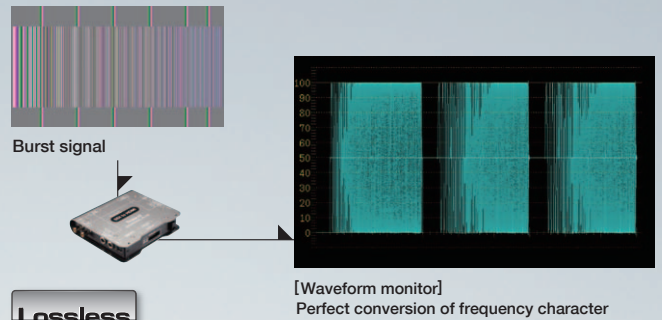

Support for 1080p 3G-SDI.

Video signals beyond 1080i can be input and output. The VC-1 series supports both level A and level B 3G-SDI, letting you connect a wide variety of 3G-SDI equipment. 1080i, 720p, and SD signals are accommodated automatically on connection.



Interlaced (1080/60i)

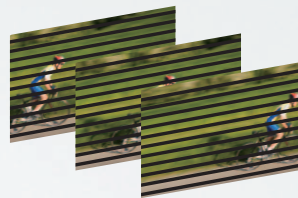

Progressive (1080/60p)

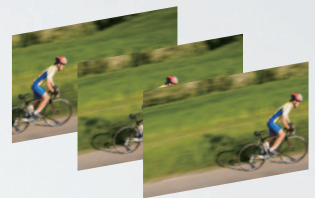

High quality and rugged construction for the rigors of front-line use.

High quality, smart design.

The exterior plating is aluminum at 2 millimeters thick. The connectors laid out inside the exterior plates are fastened to the chassis with nuts and bolts. This makes for a heavy-duty specification that can keep the connectors from coming loose even with frequent cable changes, as well as withstanding impact and drops. Every connector has an LED input indicator enabling you to confirm the status of signal transmission at a glance. The series is built for uncompromising reliability that includes accurate operation even over long periods of continuous use thanks to a design featuring exceptional heat-radiating efficiency.



Connectors fastened with nuts or screws. LED input indicators for confirming signals

A form factor that accommodates use on-the-go.

Cutaway areas in the exterior plate enable you to fasten the unit to tripods or the like using velcro or elastic ties. This makes for convenient placement and setup even during live on-site use.



Attached to a tripod for mobile production

Support for HDCP HDMI signals.

The VC-1 series is compliant with HDCP. For example, the VC-1-DL can take HDCP-applied HDMI input signals, apply frame synchronization or delay, and produce HDCP-applied HDMI output. This allows the VC-1 series to be used in any HDCP-based system with no worries.

* HDCP-applied HDMI signals cannot be converted to SDI and recorded to HDMI recorders and editors.



Support for workflow combining audio and video.

Audio embedding and de-embedding features are provided (channel-selectable) in the VC-1 Series. The audio embedding feature lets you place audio signals from a different source into the video output. For example, when converting an SDI signal to HDMI, you can use the audio embedding feature to output high-quality audio from any of the SDI audio channels. Digital (AES/EBU) input and output are also supported, letting you exchange sound between professional audio equipment with no degradation in signal. Analog input and output is supported as well making it possible to both monitor and input audio to/from a wide variety of equipment such as an audio console.



Easy configuration with DIP switches or dedicated PC/Mac software app.

DIP switches make it simple to accommodate on-site requirements. Change the conversion direction or other settings by simply sliding a DIP switch on the side of the unit. Delay Dials (VC-1-DL only) set the amount of delay for video and audio. Set the amount of delay independently for video and audio in a range of 0 to 9 fields (0 to 4.5 frames). Connection to a computer via USB cable unlocks even greater versatility with advanced settings including a memory location to lock in a favorite configuration. Control and configure multiple VC-1 units at the same time using a USB hub.

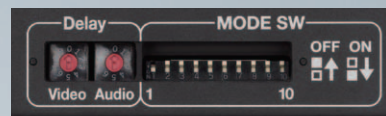

Delay Dials (VC-1-DL only) and DIP switches on side panel

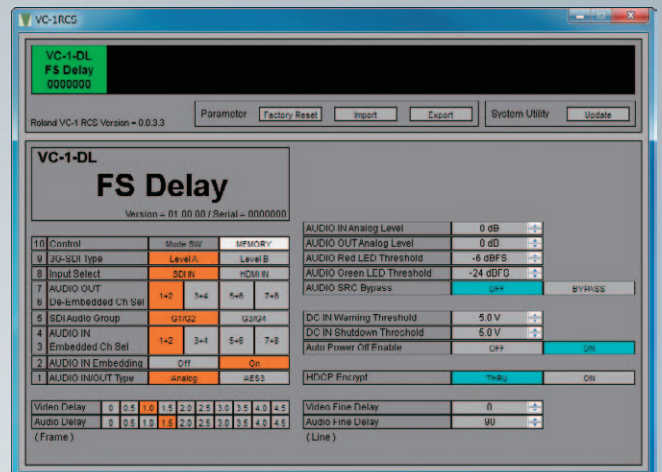

VC-1 RCS

*The VC-1 RCS for PC/Mac can be downloaded from www.rolandsystemsgroup.net.

VC-1 Series

SDI to HDMI VC-1-SH

Conversion of video and audio signals from SDI input to HDMI output

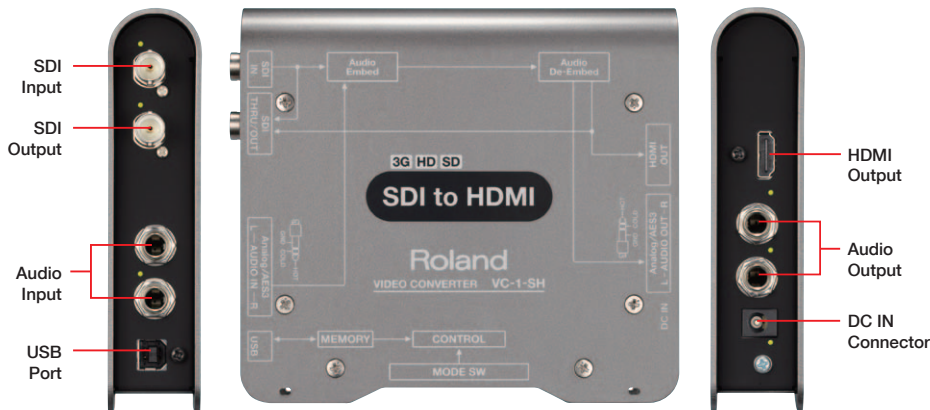

- SDI to HDMI Conversion
- Lossless image conversion
- 3G (Level A&B)/HD/SD SDI
- HDCP support
- Selectable Channel for Embedded/De-Embedded Audio

*Up/Down/Cross, Frame rate, I/P, and Aspect ratio conversion are not supported.

MODE DIP SW

NO	MODE	OFF	ON
10	CONTROL	MODE SW	MEMORY
9	HDCP Encrypt	OFF	ON
8	SDI THRU/OUT	THRU	OUT
7	AUDIO OUT De-Embedded Ch Sel	1 + 2	3 + 4 5 + 6 7 + 8
6			
5	SDI Audio Group	G1/G2	G3/G4
4	AUDIO IN Embedded Ch Sel	1 + 2	3 + 4 5 + 6 7 + 8
3			
2	AUDIO IN Embedding	OFF	ON
1	AUDIO IN/OUT Type	Analog	AES3

Block Diagram

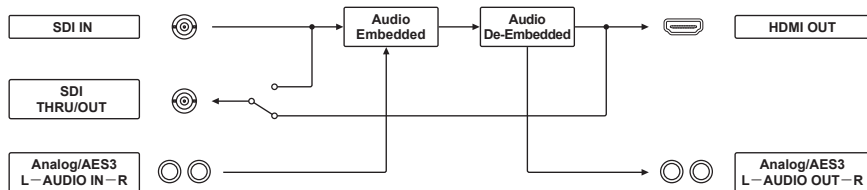

HDMI to SDI VC-1-HS

Conversion of video and audio signals from HDMI input to SDI output

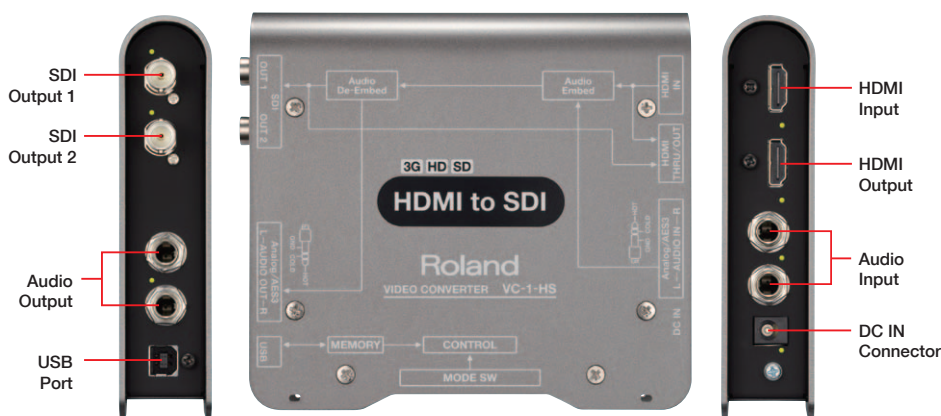

- HDMI to SDI Conversion
- Lossless image conversion
- 3G (Level A&B)/HD/SD SDI
- HDCP support
- Selectable Channel for Embedded/De-Embedded Audio

*Up/Down/Cross, Frame rate, I/P, and Aspect ratio conversion are not supported.

MODE DIP SW

NO	MODE	OFF	ON
10	CONTROL	MODE SW	MEMORY
9	3G-SDI Type	Level A	Level B
8	HDMI THRU/OUT	THRU	OUT
7	AUDIO OUT De-Embedded Ch Sel	1 + 2	3 + 4 5 + 6 7 + 8
6			
5	SDI Audio Group	G1/G2	G3/G4
4	AUDIO IN Embedded Ch Sel	1 + 2	3 + 4 5 + 6 7 + 8
3			
2	AUDIO IN Embedding	OFF	ON
1	AUDIO IN/OUT Type	Analog	AES3

Block Diagram

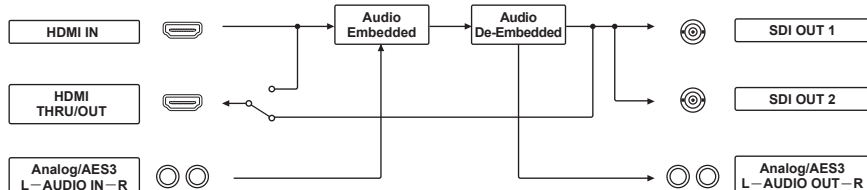

FS Delay VC-1-DL

Bi-directional Conversion of video and audio signals from HDMI to SDI or SDI to HDMI with Frame Sync and Delay

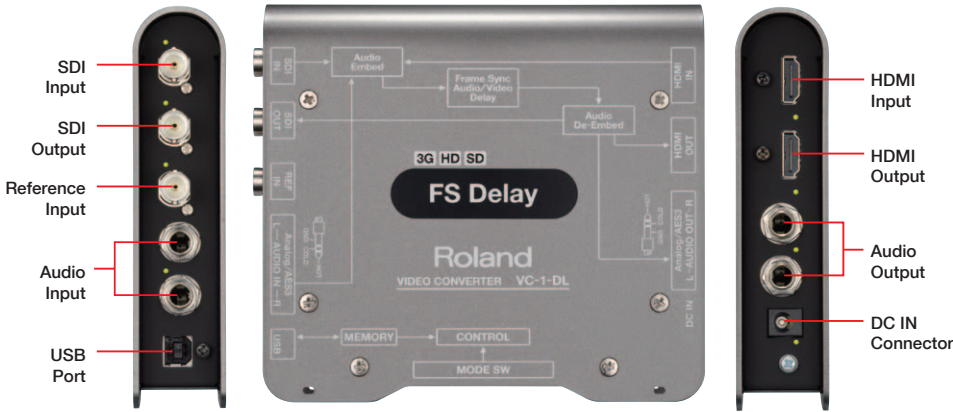

- HDMI to SDI Conversion
- SDI to HDMI Conversion
- Lossless image conversion
- 3G (Level A&B)/HD/SD SDI
- HDCP support
- Selectable Channel for Embedded/De-Embedded Audio
- Audio Delay - up to 9 fields (4.5 frames)
- Video Delay - up to 9 fields (4.5 frames)

*Up/Down/Cross, Frame rate, I/P, and Aspect ratio conversion are not supported.

*When frame synchronizer is working, CH 3-8 of HDMI and CH 3-16 of SDI audio output are not available.

Block Diagram

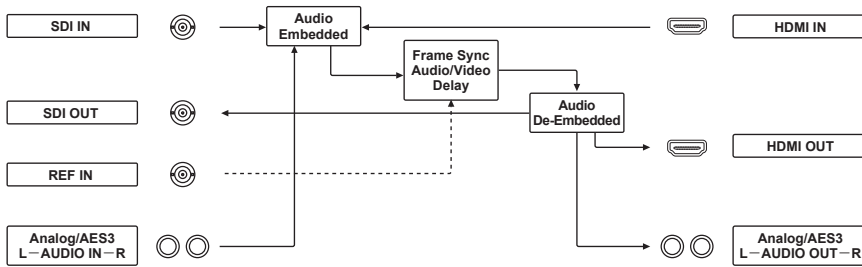

MODE DIP SW

NO	MODE	OFF	ON
10	CONTROL	MODE SW	MEMORY
9	3G-SDI Type	Level A	Level B
8	Input Select	SDI IN	HDMI IN
7	AUDIO OUT De-Embedded Ch Sel	1+2	3+4 5+6 7+8
6			
5	SDI Audio Group	G1/G2	G3/G4
4	AUDIO IN Embedded Ch Sel	1+2	3+4 5+6 7+8
3			
2	AUDIO IN Embedding	OFF	ON
1	AUDIO IN/OUT Type	Analog	AES3
Audio Delay		x0.5 Frame (x1.0 Field)	
Video Delay		x0.5 Frame (x1.0 Field)	

[Application for live video production]

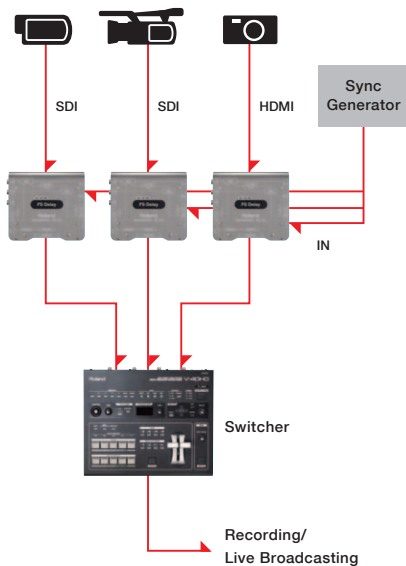

Synchronizing signal for asynchronous cameras

[Application for event]

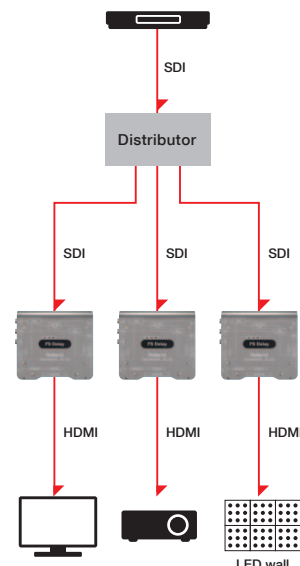

Adjustment of timing among different displays

VC-1 RCS for PC/Mac

10	Control	Mode SW	MEMORY
9	3G-SDI Type	Level A	Level B
8	Input Select	SDI IN	HDMI IN
7	AUDIO OUT De-Embedded Ch Sel	1+2	3+4 5+6 7+8
6			
5	SDI Audio Group	G1/G2	G3/G4
4	AUDIO IN Embedded Ch Sel	1+2	3+4 5+6 7+8
3			
2	AUDIO IN Embedding	Off	On
1	AUDIO IN/OUT Type	Analog	AES3
Video Delay		0 0.5 1.0 1.5 2.0 2.5 3.0 3.5 4.0 4.5	
Audio Delay		0 0.5 1.0 1.5 2.0 2.5 3.0 3.5 4.0 4.5	

(Frame)

AUDIO IN Analog Level	0 dB	+	-
AUDIO OUT Analog Level	0 dB	+	-
AUDIO Red LED Threshold	-6 dBFS	+	-
AUDIO Green LED Threshold	-24 dBFS	+	-
AUDIO SRC Bypass	OFF	ON	BYPASS
DC IN Warning Threshold	5.0 V	+	-
DC IN Shutdown Threshold	5.0 V	+	-
Auto Power Off Enable	OFF	ON	
HDCP Encrypt	THRU	ON	
Video Fine Delay	0	+	-
Audio Fine Delay	90	+	-

(Line)

■ Specifications

HDMI to SDI:VC-1-HS

Input		
HDMI	Connector	Type A (19 pins) x 1
Analog Audio	Connector	1/4" TRS phone type (balanced) x 1 pair (L/R)
Digital Audio	Connector	1/4" TRS phone type (balanced) x 1 (Combined use with Analog Audio R ch Connector)
Processing		
Audio embedding		
Audio de-embedding		
Output		
SDI	Connector	BNC type x 2
HDMI	Connector	Type A (19 pins) x 1 (Thru/Out)
Analog Audio	Connector	1/4" TRS phone type (balanced) x 1 pair (L/R)
Digital Audio	Connector	1/4" TRS phone type (balanced) x 1 (Combined use with Analog Audio R ch Connector)

SDI to HDMI:VC-1-SH

Input		
SDI	Connector	BNC type x 1
Analog Audio	Connector	1/4" TRS phone type (balanced) x 1 pair (L/R)
Digital Audio	Connector	1/4" TRS phone type (balanced) x 1 (Combined use with Analog Audio R ch Connector)
Processing		
Audio embedding		
Audio de-embedding		
Output		
SDI	Connector	BNC type x 1 (Thru/Out)
HDMI	Connector	Type A (19 pins) x 1
Analog Audio	Connector	1/4" TRS phone type (balanced) x 1 pair (L/R)
Digital Audio	Connector	1/4" TRS phone type (balanced) x 1 (Combined use with Analog Audio R ch Connector)

FS Delay:VC-1-DL

Input		
SDI	Connector	BNC type x 1
HDMI	Connector	Type A (19 pins) x 1
Analog Audio	Connector	1/4" TRS phone type (balanced) x 1 pair (L/R)
Digital Audio	Connector	1/4" TRS phone type (balanced) x 1 (Combined use with Analog Audio R ch Connector)
	Connector	BNC type x 1
Reference	Signal Format	Black Burst, Bi-level, Tri-level
	Impedance	75 ohms
Processing		
Video delay (0 to 4.5 frames)		
Audio delay (0 to 4.5 frames)		
Audio embedding		
Audio de-embedding		
Frame Synchronize (Enabled when reference signal is present) *1		
Output		
SDI	Connector	BNC type x 1
HDMI	Connector	Type A (19 pins) x 1
Analog Audio	Connector	1/4" TRS phone type (balanced) x 1 pair (L/R)
Digital Audio	Connector	1/4" TRS phone type (balanced) x 1 (Combined use with Analog Audio R ch Connector)

*1: VC-1-DL only (When frame synchronizer is working, CH 3-8 of HDMI and CH 3-16 of SDI audio output are not available.)

■ VC-1 Common Specifications



Input / Output Format		
SDI Input	Signal Standards	SMPTE 424M (SMPTE 425M-AB), SMPTE 292M, SMPTE 259M-C
	Video Format	1920x1080/60p/59.94p/30p/29.97p/25p/24p/23.98p/60i/59.94i/50i (Conforms to SMPTE 274M), 1280x720/60p/59.94p/30p/29.97p/25p (Conforms to SMPTE 296M), 720x487/59.94i, 720x576/50i (Conforms to ITU-R BT.601-5)
	Audio Format	Linear PCM, 24 bits, 48 kHz, 16 ch *1 (Conforms to SMPTE 299M, SMPTE 272M-C)
HDMI Input	Video Format	1920x1080/60p/59.94p/30p/29.97p/25p/24p/23.98p/60i/59.94i/50i, 1280x720/60p/59.94p/30p/29.97p/25p, 720x480/59.94i, 720x576/50i (Conforms to CEA-861-E)
	Audio Format	Linear PCM, 24 bit, 48 kHz, 8 ch *1
SDI Output	Signal Standards	SMPTE 424M (SMPTE 425M-AB), SMPTE 292M, SMPTE 259M-C
	Video Format	1920x1080/60p/59.94p/30p/29.97p/25p/24p/23.98p/60i/59.94i/50i (Conforms to SMPTE 274M), 1280x720/60p/59.94p/30p/29.97p/25p (Conforms to SMPTE 296M), 720x487/59.94i, 720x576/50i (Conforms to ITU-R BT.601-5)
	Audio Format	Linear PCM, 24 bits, 48 kHz, 16 ch *1 (Conforms to SMPTE 299M, SMPTE 272M-C)
HDMI Output	Video Format	1920x1080/60p/59.94p/30p/29.97p/25p/24p/23.98p/60i/59.94i/50i, 1280x720/60p/59.94p/30p/29.97p/25p, 720x480/59.94i, 720x576/50i (Conforms to CEA-861-E)
	Audio Format	Linear PCM, 24 bit, 48 kHz, 8 ch *1
Audio Input / Output		Others
Analog Audio Input	Input Level	+4dBu
	Maximum Input Level	+24dBu
	Impedance	150 k ohms
Digital Audio Input	Signal Format	AES3, 16/24 bits, 32/48 kHz, 2 ch
	Impedance	110 ohms
Analog Audio Output	Output Level	+4dBu
	Impedance	600 ohms
Digital Audio Output	Signal Format	AES3, 16/24 bits, 32/48 kHz, 2 ch
	Impedance	110 ohms
		USB Connector
		Power Supply
		Power Consumption
		Dimensions
		Weight
		Operation Temperature
		Accessories

(0dBu=0.775Vrms)

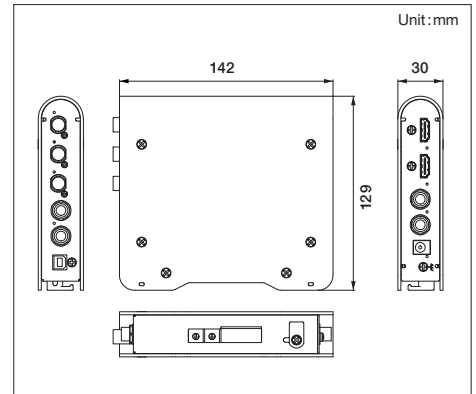
■ Dimensions



■ Related Items

 <p>VC-300HD</p> <p>Bi-Directional Multi-Format Converter with Built-in Audio Delay</p> <table border="1"> <tr> <td>HDV</td> <td>DV</td> <td>HD-SDI</td> <td>SD-SDI</td> </tr> <tr> <td>DVI</td> <td>RGB</td> <td>HDMI</td> <td>COMPONENT</td> </tr> </table>	HDV	DV	HD-SDI	SD-SDI	DVI	RGB	HDMI	COMPONENT	 <p>VC-50HD</p> <p>Bi-directional video conversion between HD/SD-SDI and MPEG-2 TS/HDV/DV</p> <table border="1"> <tr> <td>HDV</td> <td>DV</td> <td>MPEG-2TS</td> </tr> <tr> <td>HD-SDI</td> <td>SD-SDI</td> <td>HDMI</td> </tr> </table>	HDV	DV	MPEG-2TS	HD-SDI	SD-SDI	HDMI	 <p>VC-30HD</p> <p>Audio/Video Converter for Webstreaming and Capture/Archiving</p> <table border="1"> <tr> <td>HDV</td> <td>DV</td> <td>MPEG-2TS</td> <td>HDMI</td> </tr> <tr> <td>COMPONENT</td> <td>S-VIDEO</td> <td>COMPOSITE</td> <td></td> </tr> </table>	HDV	DV	MPEG-2TS	HDMI	COMPONENT	S-VIDEO	COMPOSITE	
HDV	DV	HD-SDI	SD-SDI																					
DVI	RGB	HDMI	COMPONENT																					
HDV	DV	MPEG-2TS																						
HD-SDI	SD-SDI	HDMI																						
HDV	DV	MPEG-2TS	HDMI																					
COMPONENT	S-VIDEO	COMPOSITE																						



Roland Systems Group, a member of the worldwide group of Roland companies, is dedicated to the support of audio and video professionals demanding excellence in both performance and system design. Through the development and support of video and audio products, we endeavor to improve workflow and maximize creative possibilities.

Ensuring high quality while protecting the environment: Roland is ISO9001 and ISO14001 certified

At Roland, several group companies have obtained ISO9001 certification. In addition, in January 1999, Roland also received ISO14001 international environmental management system certification. We're actively seeking ways to maintain harmony with the environment.

(ISO=International Standardization Organization: an organization for the promotion of standardization of international units and terms. They provide different categories of certification: ISO9001 Series certification is a product quality certification for products that undergo a certain level of quality control from the design stage to the after service stage; ISO14001 Series certification is for environment-related standards. Each member of the Roland Group is striving to obtain certification.)



www.rolandsystemsgroup.net

All specifications and appearances are subject to change without notice. Company names and product names appearing in this document are registered trademarks or trademarks of their respective owners. Roland is either registered trademark or trademark of Roland Corporation in the United States and/or other countries. It is forbidden by law to make an audio recording, video recording, copy or revision of a third party's copyrighted work (musical work, video work, broadcast, live performance, or other work), whether in whole or in part, and distribute, sell, lease, perform, or broadcast it without the permission of the copyright owner. Do not use this product for purposes that could infringe on a copyright held by a third party. We assume no responsibility whatsoever with regard to any infringements of third-party copyrights arising through your use of this product. Copyright 2012 Roland Corporation. All right reserved.