

DENON DJ

PRIME 4

PRIME 4+

PRIME 2

PRIME GO

SC LIVE 4

SC LIVE 2

User Guide

English

Table of Contents

- Introduction.....5**
- Support..... 5
- Product Registration5
- Devices & File Analysis 6
- Configuration 6

- Features7**
- PRIME 4 / PRIME 4+ 7
- Top Panel.....7
- Front Panel..... 12
- Rear Panel 12
- PRIME 214
- Top Panel..... 14
- Front Panel..... 18
- Rear Panel 18
- PRIME GO.....19
- Top Panel..... 19
- Front Panel.....23
- Rear Panel23
- SC LIVE 4 24
- Top Panel.....24
- Jog Display.....27
- Front Panel.....28
- Rear Panel28
- SC LIVE 2 29
- Top Panel.....29
- Front Panel.....32
- Rear Panel33

Operation	34
Touchscreen Overview	34
Performance View.....	34
Track Overview & Waveform.....	34
Central Library Preview	40
Toolbar.....	40
Library View	41
Platter Display Overview	43
Performing.....	44
Loading Tracks.....	44
Searching & Filtering Tracks.....	45
Editing Playlists.....	46
Playlist Deck.....	47
Playback & Cueing	48
Looping & Beat-Jumping	49
Syncing & Pitch Adjustment	49
Beat Grid Editing	50
Pad Modes.....	51
Hot Cue Mode.....	51
Loop Modes	51
Roll Mode	52
Slicer Modes.....	52
Sampler Mode.....	53
Touch FX.....	54
Control Center	55
Parameters	55
PRIME 4 / PRIME 4+.....	55
PRIME 2.....	56
PRIME GO	57
SC LIVE 4.....	58
SC LIVE 2.....	59

- User Profile.....60
- Settings62
 - PRIME 4 / PRIME 4+ 62
 - PRIME 2 64
 - PRIME GO 66
 - SC LIVE 4..... 68
 - SC LIVE 2..... 70
- Source.....72
 - Engine Remote Library 73
- Wi-Fi.....73
- Record74
- Engine Lighting.....75
 - Preferences 76

- Appendix77**
 - SATA Drive Installation 77
 - FX Parameters 78
 - BPM Effects78
 - Touch FX.....85
 - Technical Specifications 87
 - PRIME 4 / PRIME 4+..... 87
 - PRIME 289
 - PRIME GO 91
 - SC LIVE 493
 - SC LIVE 295
 - Trademarks & Licenses 96

Introduction

Thank you for purchasing your EngineOS hardware. At Denon DJ, we know how serious music is to you. That's why we design our equipment with only one thing in mind—to make your performance the best it can be. We're honored and excited to play a part in your musical & creative DJ journey!

Support

For the latest information about this product (documentation, technical specifications, system requirements, compatibility information, etc.) and product registration, visit denondj.com.

For additional product support, visit denondj.com/support.

Product Registration

Your product may include exclusive software and/or promotions which can only be accessed by registering your new product on the Denon DJ website.

To check eligibility and access the available content, please register your product by following the instructions below:

1. Visit denondj.com and click **Account**.
2. Click **Sign In** to access your existing account, or create a new account.
3. Once signed in, click **Register New Product**.
4. Enter the product serial number into the box and click **Check Serial**.
5. Complete the form and click **Register Your Product**.
6. Upon successful registration, any applicable software downloads, exclusive content, and promotional offers will be shown in your account.

Devices & File Analysis

All EngineOS hardware can play music files from USB drives, SD cards, or other connected EngineOS media players. Make sure you are using only the supported file systems (for USB drives or SD cards) and file formats (for music files) listed below.

Supported file systems: exFAT (recommended), FAT32

Supported file formats: AAC/M4A	MP3 (32–320 kbps)
AIF/AIFF (44.1–192 kHz, 16–32-bit)	MP4
ALAC	Ogg Vorbis
FLAC	WAV (44.1–192 kHz, 16–32-bit)

Although EngineOS hardware can play tracks that have not been analyzed yet, pre-analyzing them allows its features to work most effectively. You can analyze tracks in one of two ways:

- **On EngineOS hardware, load the track:** When you load a track to play, the hardware will automatically analyze it (if it has not already been analyzed). This may take a moment to complete, depending on the length of the track. You can start playing the track from the beginning **immediately**, though you will need to wait a moment for the analysis to finish.
- **Use Engine DJ software:** The included Engine DJ software can pre-analyze your music library to use with your hardware. You can also use it to organize your library by creating playlists. It also manages your hardware preferences (see [Operation](#) to learn more about this).

Visit enginedj.com/downloads to download the Engine DJ software.

To eject a USB drive or SD card:

1. Make sure none of its tracks are being played on any connected EngineOS media players. Ejecting a device unloads its tracks from **all** networked media players.
2. Press **Eject**, or open the **Source** menu. A list of connected devices will appear in the main display.
3. Tap the eject icon for the device you would like to eject. If a track on the device is currently playing, you will be asked if you want to continue ejecting, which will stop the track and clear the deck. Tap **Cancel** to cancel ejecting the device, or tap **Eject Anyway** to eject it.

To eject additional devices, repeat Step 3.

To return to the previous screen, press **Eject** again, or tap the **X** in the upper-right corner.

Configuration

EngineOS hardware has several settings that you can customize in the [User Profile](#) and [Settings](#) menus. See [Control Center](#) to learn about these settings.

When your EngineOS hardware is powered on, you will be presented with a Wi-Fi connection menu to connect to your local network. You can dismiss this screen each time, or set it to not show again at startup. You can adjust your connection settings at any time using the [Wi-Fi](#) menu in the Control Center.

Features

PRIME 4 / PRIME 4+

Note: All features and functions of PRIME 4 mentioned throughout this guide also apply to PRIME 4+ unless otherwise noted.

Top Panel

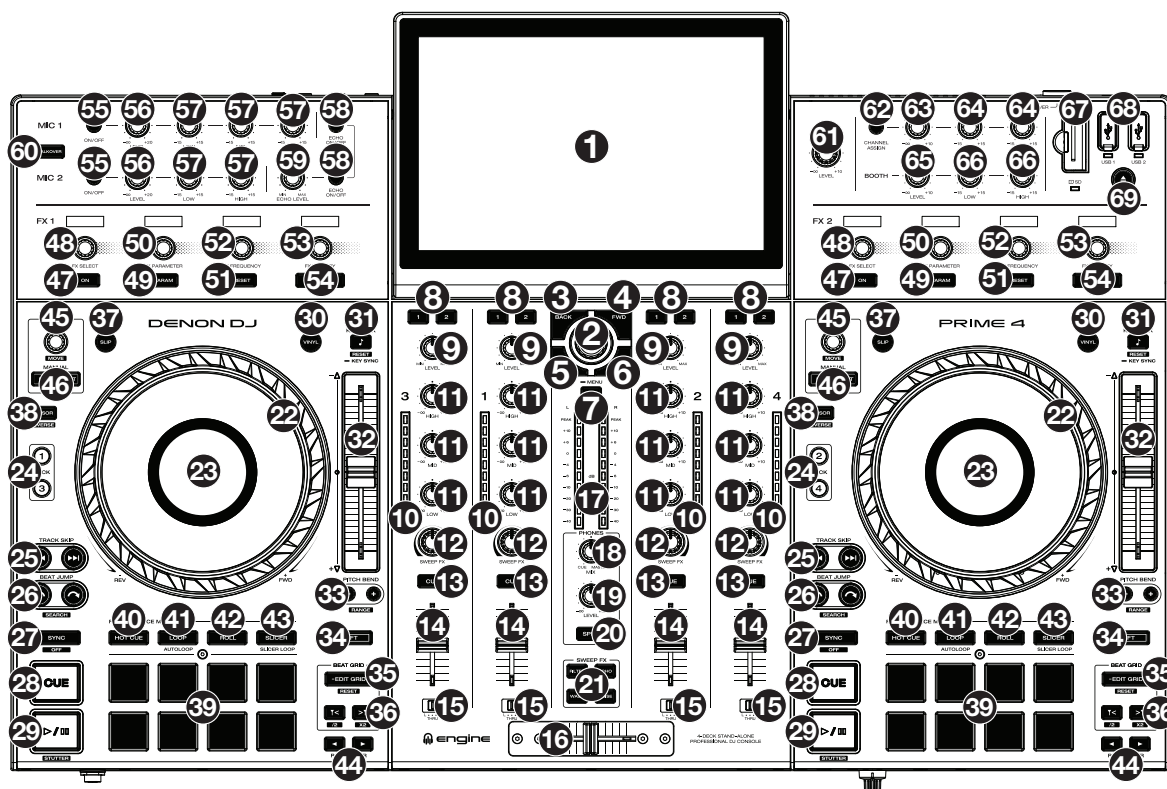

1. **Touchscreen:** This full-color multi-touch display shows information relevant to PRIME 4's current operation. Touch the touchscreen (and use the hardware controls) to control the PRIME 4 interface. See [Touchscreen Overview](#) for more information.

Tip: If you adjust the angle of the touchscreen, use the stand on its back panel to secure it in place.

2. **Browse Knob:** Turn this knob to navigate through lists. Press the knob to move forward in the touchscreen or select an item.
Press and hold **Shift** and then press this knob to send the selected track to the Prepare list.
3. **Back:** While in Library View, press this button to move to the previous window. While in Performance View, press this button to enter Library View.
4. **Forward (FWD):** While in Library View, press this button to move to the next window. While in Performance View, press this button to enter Library View.
Press and hold **Shift** and then press this button to turn **Quantize** on or off.
5. **Load ◀:** Press this button to load the selected track to Deck 1 or Deck 3.
Quickly double-press this button to instant double the track currently playing on the focused right deck (2/4) to the focused left deck (1/3).
6. **Load ▶:** Press this button to load the selected track to Deck 2 or Deck 4.
Quickly double-press this button to instant double the track currently playing on the focused left deck (1/3) to the focused right deck (2/4).
7. **View:** Press this button to cycle between [Library View](#) and [Performance View](#). Double-press this button to enter the [Engine Lighting](#) view.
Press and hold this button to show the Control Center, which includes quick links to other menus such as Source, Wi-Fi, Record, User Profile and Settings. See [Control Center](#) for more information.
Press and hold **Shift** and then press this button to toggle between vertical and horizontal waveforms in Performance View.

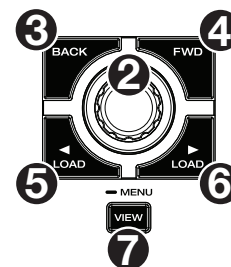

8. **Channel FX:** Use these buttons to route audio from the corresponding channel to the Effect 1 or 2 module.
9. **Channel Level:** Turn this knob to adjust the level of the pre-fader, pre-EQ audio signal for the channel.
10. **Channel Level Meters:** These LEDs display the audio signal level of the channel.
11. **Channel EQ:** Turn these knobs to boost or cut the high, mid-range, and low frequencies for the channel.
12. **Sweep FX:** Turn this knob to control the effect selected by the **Sweep FX buttons**.
13. **Channel Cue:** Press this button to send the channel's pre-fader signal to the headphones' cue channel.
14. **Channel Fader:** Use this fader to adjust the channel's volume level.
15. **Crossfader Assign:** Routes the audio playing on the corresponding channel to either side of the crossfader (**L** or **R**), or bypasses the crossfader and sends the audio directly to the program mix (center, **Thru**).
16. **Crossfader:** Use this crossfader to mix between channels assigned to the left and right sides of the crossfader.
17. **Master/Main Level Meters:** These LEDs display the audio signal level of the main mix (sent out of the **Master/Main Outputs**).
18. **Phones Mix:** Adjusts the software's audio output to the headphones, mixing between the **cue** output and the **master/main** mix output.
19. **Phones Level:** Adjusts the volume of the headphones.
20. **Split Cue:** When this button is **On** (fully lit), the headphone audio will be "split" such that all channels sent to cue channel are summed to mono and sent to the left headphone channel and the main mix is summed to mono and sent to the right channel. When this button is **Off** (dim), the cue channel and main mix will be "blended" together. You can swap the left/right position of these channels in the **Settings** menu.
21. **Sweep FX Buttons:** Press one of these buttons to enable or disable an effect that you can control with the **Sweep FX knobs**. Only one of these buttons can be enabled at a time.
 - **Filter:** This effect applies a filter to the channel. Starting from the center (12:00) position, turn a **Sweep FX knob** counter-clockwise to apply a low-pass filter, or turn it clockwise to apply a high-pass filter.
 - **Echo:** This effect is a brief echo. Starting from the center (12:00) position, turn a **Sweep FX knob** counterclockwise to decrease the length of the delay and increase the feedback, or turn it clockwise to increase the length of the delay as well as the feedback.
 - **Noise:** This effect adds noise to the signal. Starting from the center (12:00) position, turn a **Sweep FX knob** counterclockwise to add pink noise, or turn it clockwise to add white noise.
 - **Wash Out:** This creates a transition effect. Turn a **Sweep FX knob** to its most counter-clockwise (minimum) position to apply a 1-beat echo that will also mute the channel's normal audio signal, or turn it to its most clockwise (maximum) position to apply a 1/2-beat echo.

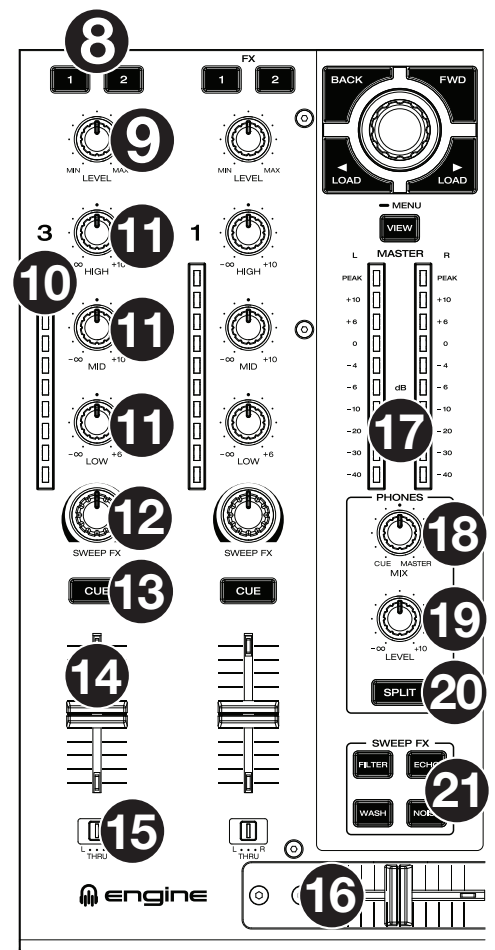

22. **Platter:** This capacitive, touch-sensitive platter controls the audio playhead when the wheel is touched and moved. When the **Vinyl** button is on, move the **platter** to “scratch” the track as you would with a vinyl record. When the **Vinyl** button is off (or if you are touching only the side of the **platter**), move the **platter** to temporarily adjust the track’s speed.

23. **Platter Display:** This display shows track artwork and information relevant to the performance, including the current playhead position, the current auto loop size, or current layer. See [Platter Display Overview](#) for more information.

24. **Deck:** Selects which deck in the software is controlled by that hardware deck. The left deck can control Deck 1 or 3; the right deck can control Deck 2 or 4.

Press and hold **Shift** and then press the Deck 3 or Deck 4 buttons to switch between four-deck and two-deck operation.

If an LC6000 PRIME unit is connected to **Rear USB Ports 3** and/or **4**, the respective Deck button(s) will be disabled.

25. **Track Skip:** Press either of these buttons to skip to the previous or next track.

Press the **Previous Track** button in the middle of a paused track to return to the beginning of the track.

Press and hold **Shift** and then press one of these buttons to search backward or forward through the track.

26. **Beat Jump:** Press either of these buttons to skip backward or forward through the track.

Press and hold **Shift** and press one of these buttons to increase or decrease the beat jump size.

27. **Sync / Sync Off:** Press this button to activate sync.

Press and hold **Shift** and press this button to deactivate Sync. You can also set Sync to deactivate without using Shift by changing the **Sync Button Action** setting in the [User Profile](#) menu.

28. **Cue:** During playback, press this button to return the track to the initial cue point and stop playback. (To move the initial cue point, make sure the track is paused, move the **platter** to place the audio playhead at the desired location, and then press this button.) If the deck is paused, press and hold this button to temporarily play the track from the initial cue point. Release the button to return the track to the initial cue point and pause it. To continue playback without returning to the initial cue point, press and hold this button and then press and hold the **Play** button, and then release both buttons.

During playback, press and hold **Shift** and press this button to set the initial cue point at the current playhead position.

29. **Play/Pause:** This button pauses or resumes playback.

Press and hold **Shift** and then press this button to “stutter-play” the track from the initial cue point.

30. **Vinyl:** Press this button to activate/deactivate a “vinyl mode” for the platter. When activated, you can use the **platter** to “scratch” the track as you would with a vinyl record.

31. **Key Lock / Key Sync:** Press this button to activate/deactivate Key Lock. When Key Lock is activated, the track’s key will remain the same (0%) even if you adjust its speed. Press and hold **Shift** and press this button to reset Key Lock.

During playback, press and hold this button to activate key sync for the current track.

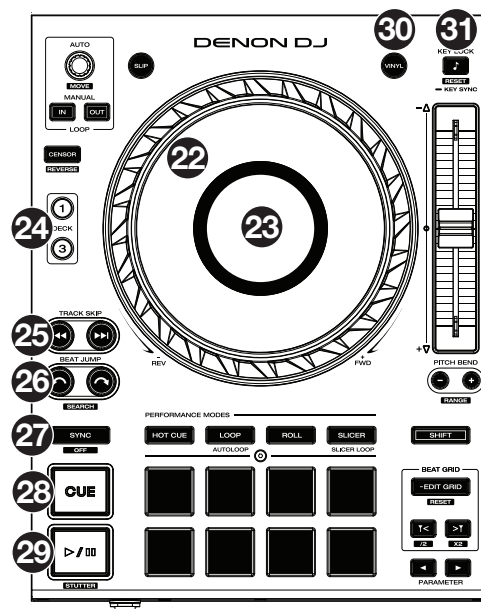

32. **Pitch Fader:** Move this fader to adjust the speed (pitch) of the track. You can adjust its total range with the **Pitch Bend** buttons.

When you select another Deck with the **Deck** select buttons, the position of the **Pitch Fader** may not match the Pitch setting for the previous Deck. Slowly move the Pitch Fader in the direction indicated by the green takeover LED arrow until it turns off. At this point, the Pitch Fader matches the Pitch setting of the previous deck and can control it again.

33. **Pitch Bend -/+:** Press and hold one of these buttons to momentarily reduce or increase (respectively) the speed of the track.

Press and hold **Shift** and then press one of these buttons to set the range of the **pitch fader**.

34. **Shift:** Press and hold this button to access secondary functions of other controls.

35. **Edit Grid:** Press and hold this button to enable beat grid editing.

Press and hold **Shift** and then press this button while beat grid editing is enabled to reset the beat grid.

Press and hold **Shift** and then press and hold this button while beat grid editing is disabled to manually adjust cue/loop point locations left or right using the **touchscreen** controls.

36. **Grid Marker:** When beat grid editing is enabled, press either of these buttons to move a downbeat marker backward or forward based on the current analyzed grid.

Press and hold **Shift** and then press these buttons to halve or double the current tempo.

37. **Slip:** Press this button to enable or disable Slip Mode. In Slip Mode, you can jump to cue points, trigger loop rolls, or use the platters, while the track's timeline continues. In other words, when you stop the action, the track will resume normal playback from where it would have been if you had never done anything (i.e., as if the track had been playing forward the whole time).

38. **Censor / Reverse:** Press this button to activate/deactivate the Censor feature: the playback of the track will be reversed, but when you release the button, normal playback will resume from where it would have been if you had never engaged the Censor feature (i.e., as if the track had been playing forward the whole time).

Press and hold **Shift** and then press this button to reverse the playback of the track normally.

39. **Performance Pads:** These pads have different functions on each deck depending on the current pad mode. See [Pad Modes](#) for more information.

40. **Hot Cue:** Press this button to enter Hot Cue Mode.

41. **Loop:** Press this button once to enter Manual Loop Mode, and press it again to enter Auto Loop mode.

42. **Roll:** Press this button to enter Roll Mode.

Press and hold **Shift** and then press this button to enter Sampler Mode.

43. **Slicer:** Press this button to enter Slicer Mode, and press it again to enter Slicer Loop mode.

44. **Parameter ◀/▶:** Use these buttons for various functions in certain Pad Modes. See [Pad Modes](#) for more information.

45. **Auto Loop / Loop Move:** Turn this knob to set the size of an automatic loop. The value will be shown in the touchscreen and platter display.

Press this knob to activate or deactivate an automatic loop at the current location of the track.

Press and hold **Shift** and turn this knob to shift the active loop to the left or right.

46. **Loop In/Loop Out:** Press either of these buttons to create a Loop In or Loop Out point at the current location. Their placement will be affected by the **Quantize** and **Smart Loops** settings. See [Looping & Beat-Jumping](#) for more information.

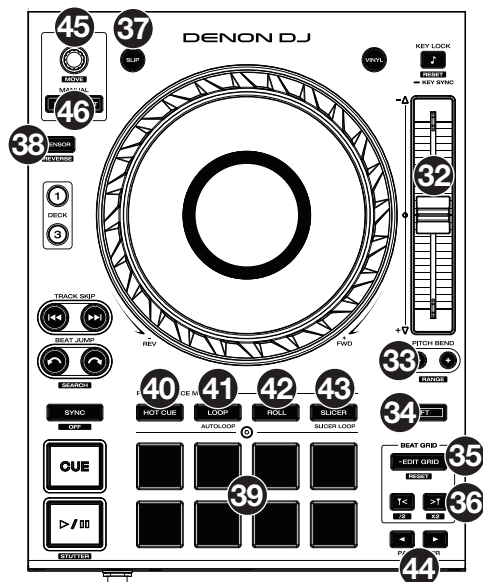

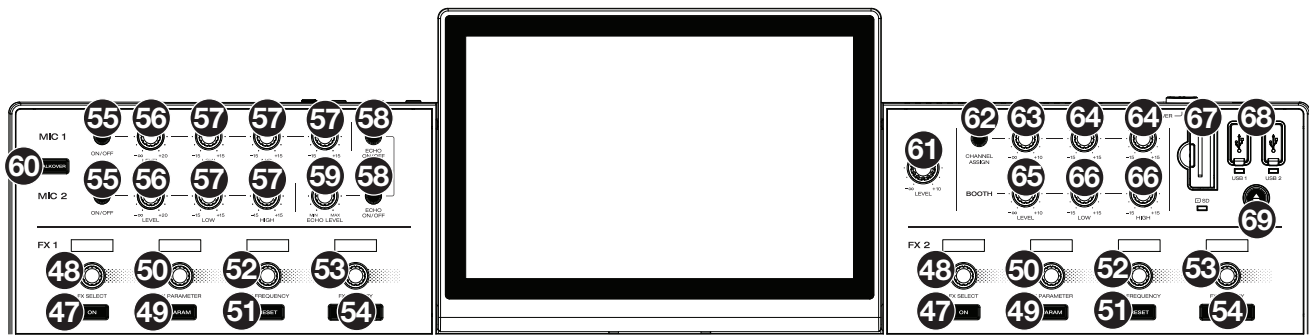

47. **FX On:** Press these buttons to enable or disable FX 1 and FX 2.
48. **FX Select:** Turn these knobs to select the active effect for FX 1 and FX 2.
49. **FX Parameter:** Press this button to reset the current effect parameter to its default setting.
50. **FX Parameter Knob:** Use these knobs to adjust the effect parameter.
51. **FX Reset:** Press these buttons to reset the FX Frequency to center.
Press and hold **Shift** and press these buttons to set the effect to its default state, with Wet/Dry set to 0.
52. **FX Frequency:** Turn this knob to select a frequency band of the audio signal to which the BPM effects will be applied. Select the center (12 o'clock) position to apply effects to the entire spectrum of frequencies.
53. **FX Wet/Dry Knob:** Turn this knob to adjust the wet/dry mix of the effects.
54. **FX Beats Buttons:** Press either of these buttons to decrease or increase the rate of time-based effects on that deck.
55. **Mic On/Off:** Press these buttons to activate/deactivate the microphones.
56. **Mic Level:** Turn these knobs to adjust the volume levels of the corresponding microphone inputs. The **Peak** light next to each knob indicates the current signal level by its color: **green** (low), **amber** (normal/optimal), or **red** (maximum/peak). You can adjust the microphone attenuation in the **Settings** menu.
- Important:** The audio signals from the microphones are routed directly to the **Master/Main Outputs**.
57. **Mic EQ:** Turn these knobs to boost or cut the high, mid-range (Mic 1 only) and low frequencies for the corresponding microphones.
58. **Echo On/Off:** Press this button to activate/deactivate the echo effect on the microphones' audio signal.
59. **Mic Echo Level:** Turn this knob to adjust the amount of the echo effect on the microphones' audio signal.
60. **Talkover:** Press this button to use the "talkover" feature, which automatically reduces the volume level of the main mix when you speak into the microphone. You can adjust the talkover level in the **Settings** menu.
61. **Master/Main Level:** Turn this knob to adjust the volume level of the **Master/Main Outputs**.
62. **Zone Channel Assign:** Press this button to set Deck 4 as a Zone Playlist, which will play from the **Zone Outputs**. By default, the main output will play through the zone if a zone playlist is not assigned.
63. **Zone Level:** Turn this knob to adjust the volume level of the **Zone Outputs**.
64. **Zone EQ:** Turn these knobs to boost or cut the high and low frequencies for the **Zone Outputs**.
65. **Booth Level:** Turn this knob to adjust the volume level of the **Booth Outputs**.
66. **Booth EQ:** Turn these knobs to boost or cut the high and low frequencies for the **Booth Outputs**.
67. **SD Card Slot:** Insert a standard SD card to this slot. When you select that SD card as a source, you can use the display to select and load tracks on your SD card.
68. **USB 1/2 Ports:** Connect standard USB flash drives to these USB ports. When you select that USB flash drive as a source, you can use the display to select and load tracks on your USB flash drive.
69. **Eject:** Press this button to bring up on the touchscreen a list of connected media devices which can be ejected. Tap one of the listed media sources to eject that device. To prevent data corruption, drives must be ejected before being removed from the player.
Press and hold **Shift** and press this button to open the **Source** menu.

Front Panel

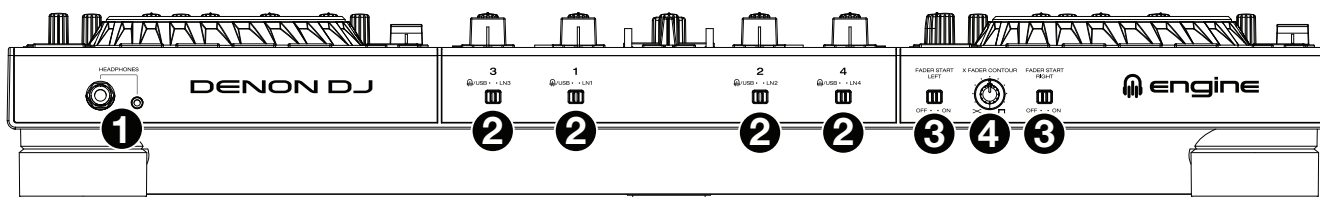

1. **Headphones (1/4", 1/8") (6.35 mm, 3.5 mm):** Connect your 1/4" or 1/8" (6.35 mm or 3.5 mm) headphones to this output for cueing and mix monitoring. The headphone volume is controlled using the **Phones Level** knob.
2. **Input Selector:** Set these switches to the desired audio source from this channel: **Engine/USB** (a track playing on that layer in the software, or from a connected USB flash drive or SD card), or **Line** (a device connected to the **inputs** on the rear panel).

Note: When using Line Inputs, only the **Filter Sweep FX** will be available.

3. **Fader Start:** Enables or disables "fader start" on the corresponding side of the crossfader. When fader start is enabled on one side, moving the crossfader toward that side will cause the deck to start playing.
4. **X-Fader Contour:** Adjusts the slope of the crossfader curve. Turn the knob to the left for a smooth fade (mixing) or to the right for a sharp cut (scratching). The center position is a typical setting for club performances.

Rear Panel

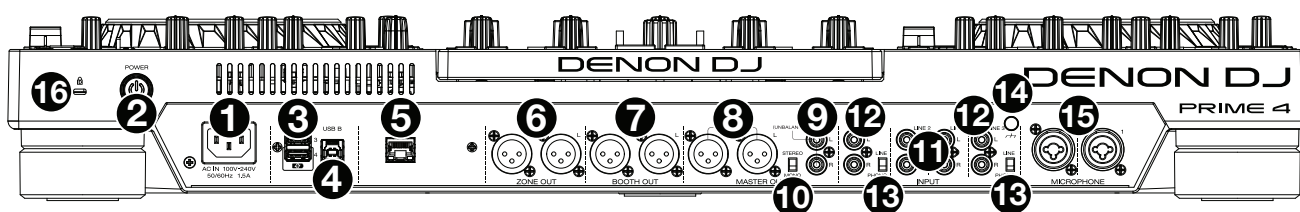

1. **Power Input:** Use the included power cable to connect this input to a power outlet.
PRIME 4 has a protection circuit to safely eject all media after an unexpected power loss to protect your data from corruption. Reconnect your power source to return to normal operation.
2. **Power Button:** Press this button to power PRIME 4 on. Power on PRIME 4 only **after** you have connected all your input devices and **before** you power on your amplifiers and loudspeakers.
To power off PRIME 4, press this button and follow the prompts on the touchscreen. Power off your amplifiers and loudspeakers **before** powering off PRIME 4.
3. **Rear USB Ports 3/4:** Connect standard USB drives to these USB ports. When you select one of those USB drives as a source, you can use the touchscreen to select and load tracks on your USB drives. There are also two similar USB ports on the top panel.
You can also use Ports 3 and 4 to connect up to two LC6000 PRIME controller units, which can then be used to control Decks 3 and 4, respectively. When connected, any tracks loaded to Decks 3 and/or 4 on PRIME 4 will be moved to Decks 1 and/or 2, and PRIME 4's **Deck** buttons will be disabled. You can then use the LC6000 PRIME's **Select/Zoom** knob to browse and load tracks directly to that deck.
4. **USB B:** Use a standard USB cable (included) to connect this USB port to an available USB port on your computer. This connection sends and receives MIDI messages to and from the computer.
5. **Link Port:** Use a standard Ethernet cable to connect this port to a computer. PRIME 4 will send time, BPM, and other track data to the compatible StagelinQ lighting and video software over this connection.
6. **Zone Out (XLR, balanced):** Use standard XLR cables to connect these outputs to loudspeakers or an amplifier system. By default, the Zone Out will send the same signal as the **Master/Main Outputs**. Alternatively, you can press the **Zone Channel Assign** button to set Deck 4 as a Zone Playlist which will be routed to these outputs. When using the Zone Channel, the level and EQ controls of Channel 4 will be bypassed; use the **Zone Level** and **Zone EQ** knobs on the top panel to control the volume level and EQ of the Zone Out signal.

7. **Booth Outputs (XLR, balanced):** Use standard XLR cables to connect these outputs to booth monitors or a booth amplifier system. Use the **Booth** knob on the top panel to control the volume level.
8. **Master/Main Outputs (XLR, balanced):** Use standard XLR cables to connect these outputs to loudspeakers or an amplifier system. Use the **Master/Main** knob on the top panel to control the volume level.
9. **Master/Main Outputs (RCA, unbalanced):** Use standard RCA cables to connect these outputs to loudspeakers or an amplifier system. Use the **Master/Main** knob on the top panel to control the volume level.
10. **Stereo/Mono:** Use this switch to set the channel configuration of the **Master/Main Outputs: Stereo** (binaural audio using separate left and right channels) or **Mono** (summed monaural audio through both left and right channels).
11. **Line Inputs (RCA, unbalanced):** Use standard RCA cables to connect these line-level inputs to an external audio source.
12. **Line/Phono Inputs (RCA, unbalanced):** Use standard RCA cables to connect these line-level or phono-level inputs to an external audio source.
13. **Phono/Line Switch:** Flip this switch to the appropriate position, depending on the device connected to the **Line/Phono Inputs**. If you are using phono-level turntables, set this switch to **Phono** to provide the additional amplification needed for phono-level signals. If using a line-level device, such as a CD player or sampler, set this switch to **Line**.
14. **Grounding Terminal:** If using phono-level turntables with a grounding wire, connect the grounding wire to these terminals. If you experience a low “hum” or “buzz”, this could mean that your turntables are not grounded.
Note: Some turntables have a grounding wire built into the RCA connection and, therefore, nothing needs to be connected to the grounding terminal.
15. **Mic Inputs (XLR or 1/4" / 6.35 mm):** Use standard XLR or 1/4" (6.35 mm) cables (not included) to connect standard dynamic microphones to these inputs. Use the **Mic 1** and **Mic 2 Level** knobs on the top panel to control the volume level.
16. **Kensington® Lock Slot:** Use this slot to secure PRIME 4 to a table or other surface.

PRIME 2

Top Panel

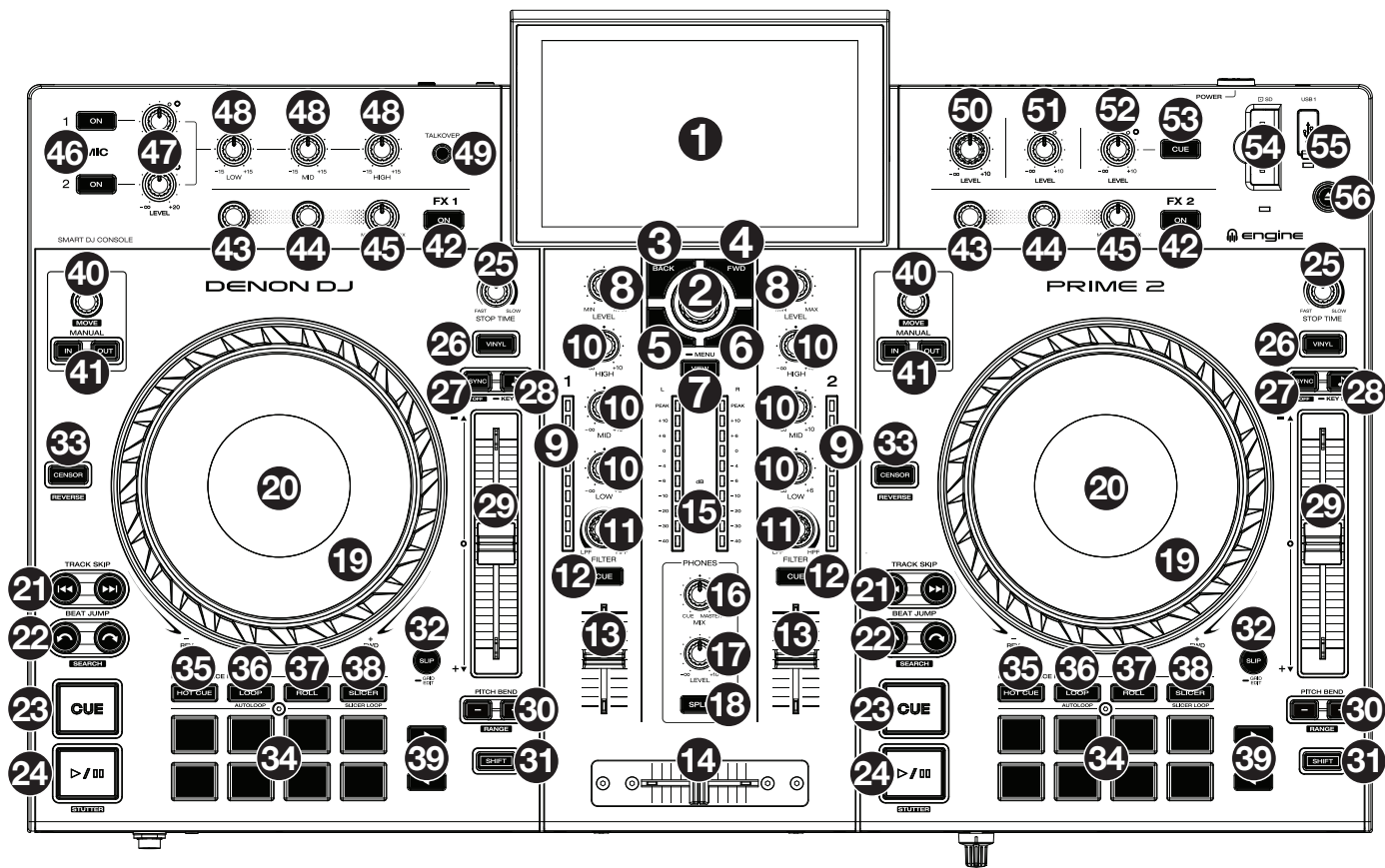

1. **Touchscreen:** This full-color multi-touch display shows information relevant to PRIME 2's current operation. Touch the touchscreen (and use the hardware controls) to control the PRIME 2 interface. See [Touchscreen Overview](#) for more information.
2. **Browse Knob:** Turn this knob to navigate through lists. Press the knob to move forward in the touchscreen or select a track to load on either deck.
Press and hold **Shift** and then press this knob to send the selected track to the Prepare list.
3. **Back:** While in Library View, press this button to move to the previous window. While in Performance View, press this button to enter Library View.
4. **Forward (FWD):** While in Library View, press this button to move to the next window. While in Performance View, press this button to enter Library View.
Press and hold **Shift** and then press this button to turn **Quantize** on or off.
5. **Load ◀:** Press this button to load the selected track to Deck 1.
Quickly double-press this button to instant double the track currently playing on Deck 2 to Deck 1.
6. **Load ▶:** Press this button to load the selected track to Deck 2.
Quickly double-press this button to instant double the track currently playing on Deck 1 to Deck 2.
7. **View:** Press this button to cycle between [Library View](#) and [Performance View](#). Double-press this button to enter the [Engine Lighting](#) view.
Press and hold this button to show the Control Center, which includes quick links to other menus such as Source, Record, User Profile and Settings. See [Control Center](#) for more information.
Press and hold **Shift** and then press this button to toggle between vertical and horizontal waveform views in Performance View.

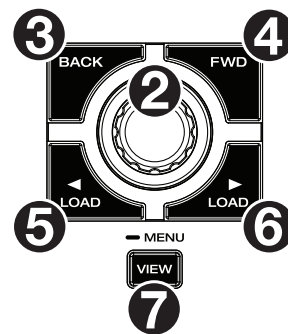

8. **Channel Level:** Turn this knob to adjust the level of the pre-fader, pre-EQ audio signal for the channel.
9. **Channel Level Meters:** These LEDs display the audio signal level of the channel.
10. **Channel EQ:** Turn these knobs to boost or cut the high, mid-range, and low frequencies for the channel.
11. **Filter:** Turn this knob to apply a filter to the channel. Starting from the center (12:00) position, turn it counter-clockwise to apply a low-pass filter, or turn it clockwise to apply a high-pass filter.
12. **Channel Cue:** Press this button to send the channel's pre-fader signal to the headphones' cue channel.
13. **Channel Fader:** Use this fader to adjust the channel's volume level.
14. **Crossfader:** Use this crossfader to mix between channels assigned to the left and right sides of the crossfader.
15. **Master Level Meters:** These LEDs display the audio signal level of the master mix (sent out of the **Master Outputs**).
16. **Phones Mix:** Adjusts the software's audio output to the headphones, mixing between the **cue** output and the **master** mix output.
17. **Phones Level:** Adjusts the volume of the headphones.
18. **Split Cue:** When this button is **On** (fully lit), the headphone audio will be "split" such that all channels sent to cue channel are summed to mono and sent to the left headphone channel and the master mix is summed to mono and sent to the right channel. When the button is **Off** (dim), the cue channel and master mix will be "blended" together.
19. **Platter:** This capacitive, touch-sensitive platter controls the audio playhead when the wheel is touched and moved. When the **Vinyl** button is on, move the **platter** to "scratch" the track as you would with a vinyl record. When the **Vinyl** button is off (or if you are touching only the side of the **platter**), move the **platter** to temporarily adjust the track's speed.
20. **Platter Display:** This display shows information relevant to the performance, including the current playhead position and auto loop size, as well as album artwork. See [Platter Display Overview](#) for more information.
21. **Track Skip:** Press either of these buttons to skip to the previous or next track.
Press the **Previous Track** button in the middle of a paused track to return to the beginning of the track.
Press and hold **Shift** and then press one of these buttons to search backward or forward through the track.
22. **Beat Jump:** Press either of these buttons to skip backward or forward through the track.
Press and hold **Shift** and press one of these buttons to increase or decrease the beat jump size.
23. **Cue:** During playback, press this button to return the track to the initial cue point and stop playback. (To move the initial cue point, make sure the track is paused, move the **platter** to place the audio playhead at the desired location, and then press this button.) If the deck is paused, press and hold this button to temporarily play the track from the initial cue point. Release the button to return the track to the initial cue point and pause it. To continue playback without returning to the initial cue point, press and hold this button and then press and hold the **Play** button, and then release both buttons.
During playback, press and hold **Shift** and press this button to set the initial cue point at the current playhead position.
24. **Play/Pause:** This button pauses or resumes playback.
Press and hold **Shift** and then press this button to "stutter-play" the track from the initial cue point.

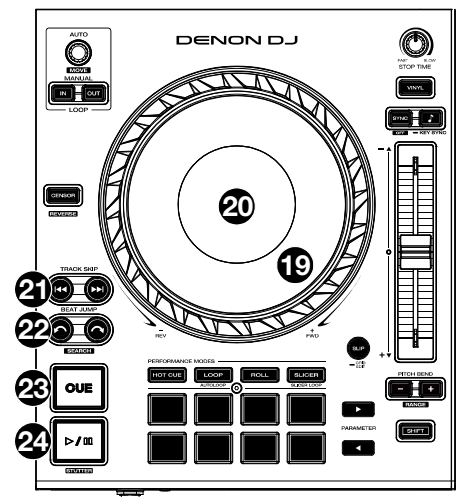
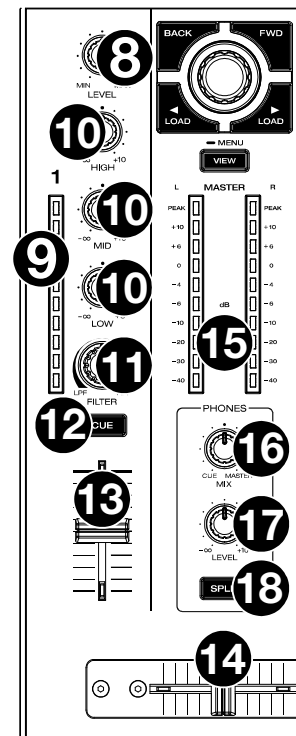

25. **Stop Time:** Controls the rate at which the track slows to a complete stop ("brake time") when you pause it by pressing **Play/Pause**.
26. **Vinyl:** Press this button to activate/deactivate a "vinyl mode" for the platter. When activated, you can use the **platter** to "scratch" the track as you would with a vinyl record.
27. **Sync / Sync Off:** Press this button to activate sync.

Press and hold **Shift** and press this button to deactivate Sync. You can also set Sync to deactivate without using Shift by changing the **Sync Button Action** setting in the [User Profile](#) menu.

28. **Key Lock / Key Sync:** Press this button to activate/deactivate Key Lock. When Key Lock is activated, the track's key will remain the same (0%) even if you adjust its speed. Press and hold **Shift** and press this button to reset Key Lock.

Press and hold this button to activate key sync.

29. **Pitch Fader:** Move this fader to adjust the speed (pitch) of the track. You can adjust its total range with the **Pitch Bend** buttons.
30. **Pitch Bend -/+:** Press and hold one of these buttons to momentarily reduce or increase (respectively) the speed of the track.
- Press and hold **Shift** and then press one of these buttons to set the range of the **pitch fader**.
31. **Shift:** Press and hold this button to access secondary functions of other controls.

32. **Slip/Grid Edit:** Press this button to enable or disable Slip Mode. In Slip Mode, you can jump to cue points, trigger loop rolls, or use the platters, while the track's timeline continues. In other words, when you stop the action, the track will resume normal playback from where it would have been if you had never done anything (i.e., as if the track had been playing forward the whole time).

Press and hold this button to enable or disable beat grid editing.

Press and hold **Shift** and then press and hold this button to manually adjust cue/loop point locations left or right using the **touchscreen** controls.

33. **Censor / Reverse:** Press this button to activate/deactivate the Censor feature: the playback of the track will be reversed, but when you release the button, normal playback will resume from where it would have been if you had never engaged the Censor feature (i.e., as if the track had been playing forward the whole time).

Press and hold **Shift** and then press this button to reverse the playback of the track normally.

34. **Performance Pads:** These pads have different functions on each deck depending on the current pad mode. See [Pad Modes](#) for more information.

35. **Hot Cue:** Press this button to enter Hot Cue Mode.

36. **Loop:** Press this button once to enter Manual Loop Mode, and press it again to enter Auto Loop Mode.

37. **Roll:** Press this button to enter Roll Mode.

Press and hold **Shift** and then press this button to enter Sampler Mode.

38. **Slicer:** Press this button once to enter Slicer Mode, and press it again to enter Slicer Loop Mode.

39. **Parameter ◀/▶:** Use these buttons for various functions in certain Pad Modes. See [Pad Modes](#) for more information.

40. **Auto Loop / Loop Move:** Turn this knob to set the size of an automatic loop. The value will be shown in the touchscreen and platter display.

Press this knob to activate or deactivate an automatic loop at the current location of the track.

Press and hold **Shift** and turn this knob to shift the active loop to the left or right.

41. **Loop In / Loop Out:** Press either of these buttons to create a Loop In or Loop Out point at the current location. Their placement will be affected by the **Quantize** and **Smart Loops** settings. See [Looping & Beat-Jumping](#) for more information.

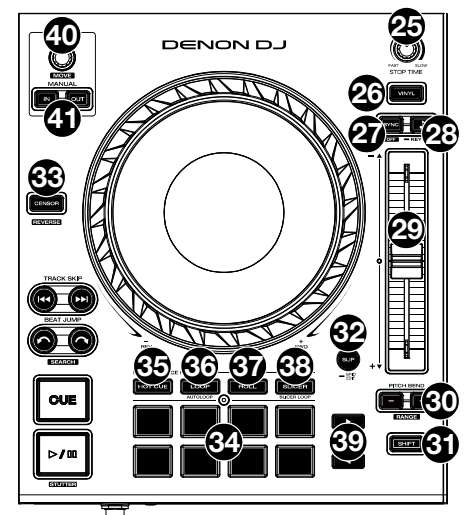

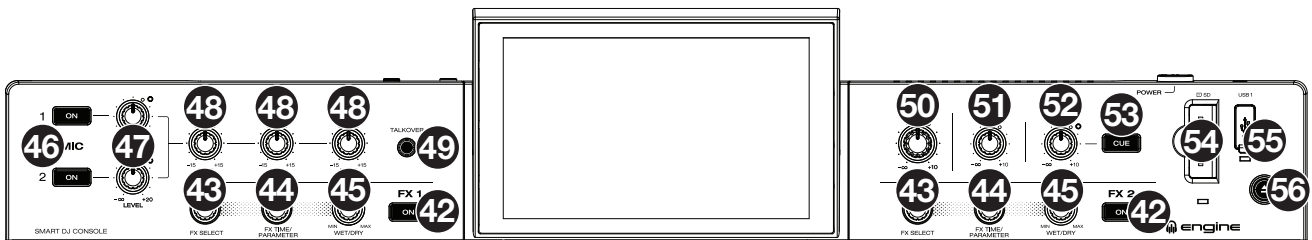

42. **FX On:** Press these buttons to enable or disable FX 1 and FX 2.

Press and hold **Shift** and press either of these buttons to show or hide the FX bar.

43. **FX Select:** Turn these knobs to select the active effect for FX 1 and FX 2.

44. **FX Time / FX Parameter:** Turn these knobs to decrease or increase the rate of time-based effects on that deck.

Press these knobs to toggle between FX Time and FX Parameter control, and then turn the knobs to adjust the parameter.

Press and hold **Shift** and press this knob to reset the current effect parameter to its default setting.

45. **FX Wet/Dry Knob:** Turn these knobs to adjust the wet/dry mix of the effects.

46. **Mic On/Off:** Press these buttons to activate/deactivate the microphones.

47. **Mic Level:** Turn these knobs to adjust the volume levels of the corresponding microphone inputs. The **Peak** light next to each knob indicates the current signal level, detected post-level pot position, by its color: **green** (low), **amber** (normal/optimal), or **red** (maximum/peak). You can adjust the microphone attenuation in the **Settings** menu.

Important: The audio signals from the microphones are routed directly to the **Master Outputs**.

48. **Mic EQ:** Turn these knobs to boost or cut the high, mid-range and low frequencies for the microphones.

49. **Talkover:** Press this button to use the “talkover” feature, which automatically reduces the volume level of the master mix when you speak into the microphone.

50. **Master Level:** Turn this knob to adjust the volume level of the **Master Outputs**.

51. **Booth Level:** Turn this knob to adjust the volume level of the **Booth Outputs**.

52. **Aux Level:** Turn this knob to adjust the volume level of the **Aux Inputs**. The **Peak** light next to this knob indicates the current signal level by its color: **green** (low), **amber** (normal/optimal), or **red** (maximum/peak). The signal level is detected pre-level pot position, so you can confirm an optimal signal before sending to the master bus.

53. **Aux Cue:** Press this button to send the aux signal to the headphones’ cue channel.

54. **SD Card Slot:** Insert a standard SD card to this slot. When you select that SD card as a source, you can use the touchscreen to select and load tracks from your SD card.

55. **USB 1 Port:** Connect a standard USB flash drive to this USB port. When you select that USB flash drive as a source, you can use the touchscreen to select and load tracks from your USB flash drive.

56. **Eject/Source:** Press this button to bring up on the touchscreen a list of connected media devices which can be ejected. Tap one of the listed media sources to eject that device. To prevent data corruption, drives must be ejected before being removed from the console.

Press and hold **Shift** and press this button to open the **Source** menu.

Front Panel

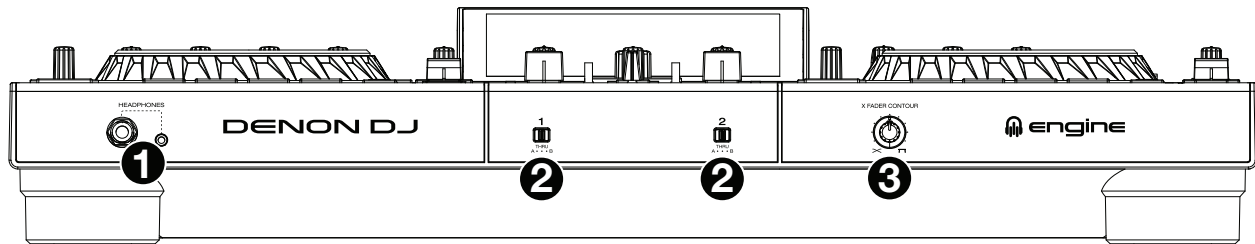

1. **Headphones (1/4", 1/8") (6.35 mm, 3.5 mm):** Connect your 1/4" or 1/8" (6.35 mm or 3.5 mm) headphones to this output for cueing and mix monitoring. The headphone volume is controlled using the **Phones Level** knob.
2. **Crossfader Assign:** Routes the audio playing on the corresponding channel to either side of the crossfader (**A** or **B**), or bypasses the crossfader and sends the audio directly to the program mix (center, **Thru**).
3. **Crossfader Contour:** Adjusts the slope of the crossfader curve. Turn the knob to the left for a smooth fade (mixing) or to the right for a sharp cut (scratching). The center position is a typical setting for club performances.

Rear Panel

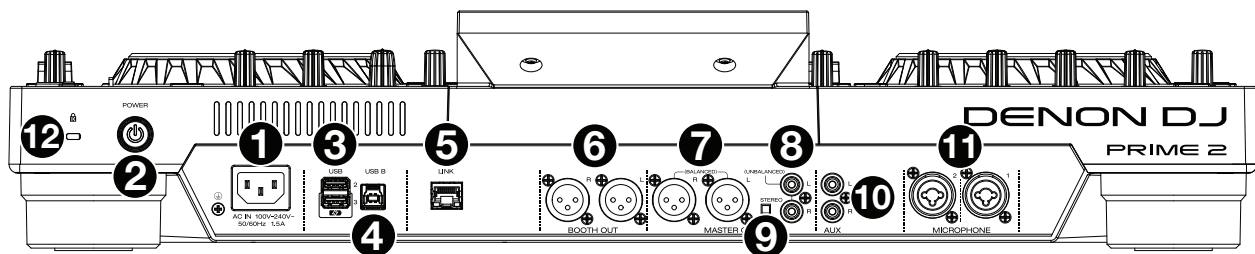

1. **Power Input:** Use the included power cable to connect this input to a power outlet. PRIME 2 has a protection circuit to safely eject all media after an unexpected power loss to protect your data from corruption. Reconnect your power source to return to normal operation.
2. **Power Button:** Press this button to power PRIME 2 on. Power on PRIME 2 only **after** you have connected all your input devices and **before** you power on your amplifiers and loudspeakers. To power off PRIME 2, press this button and follow the prompts on the touchscreen. Power off your amplifiers and loudspeakers **before** powering off PRIME 2.
3. **Rear USB Ports 2/3:** Connect standard USB drives to these USB ports. When you select one of those USB drives as a source, you can use the touchscreen to select and load tracks from your USB drives. There is also one similar USB port on the top panel.
4. **USB B:** Use a standard USB cable (included) to connect this USB port to an available USB port on your computer. This connection sends and receives MIDI messages to and from the computer.
5. **Link Port:** Use a standard Ethernet cable to connect this port to a computer. PRIME 2 will send time, BPM, and other track data to the compatible StagelinQ lighting and video software over this connection.
6. **Booth Outputs (XLR, balanced):** Use standard XLR cables to connect these outputs to booth monitors or a booth amplifier system. Use the **Booth Level** knob on the top panel to control the volume level.
7. **Master Outputs (XLR, balanced):** Use standard XLR cables to connect these outputs to loudspeakers or an amplifier system. Use the **Master Level** knob on the top panel to control the volume level.
8. **Master Outputs (RCA, unbalanced):** Use standard RCA cables to connect these outputs to loudspeakers or an amplifier system. Use the **Master Level** knob on the top panel to control the volume level.
9. **Stereo/Mono:** Use this switch to set the channel configuration of the **Master Outputs: Stereo** (binaural audio using separate left and right channels) or **Mono** (summed monaural audio through both left and right channels).
10. **Aux Inputs (RCA, unbalanced):** Use standard RCA cables to connect these line-level inputs to an external audio source. Use the **Aux Level** knob on the top panel to control the volume level.
11. **Mic Inputs (XLR or 1/4" / 6.35 mm):** Use standard XLR or 1/4" (6.35 mm) cables (not included) to connect standard dynamic microphones to these inputs. Use the **Mic 1** and **Mic 2 Level** knobs on the top panel to control the volume level.
12. **Kensington® Lock Slot:** Use this slot to secure PRIME 2 to a table or other surface.

PRIME GO

Top Panel

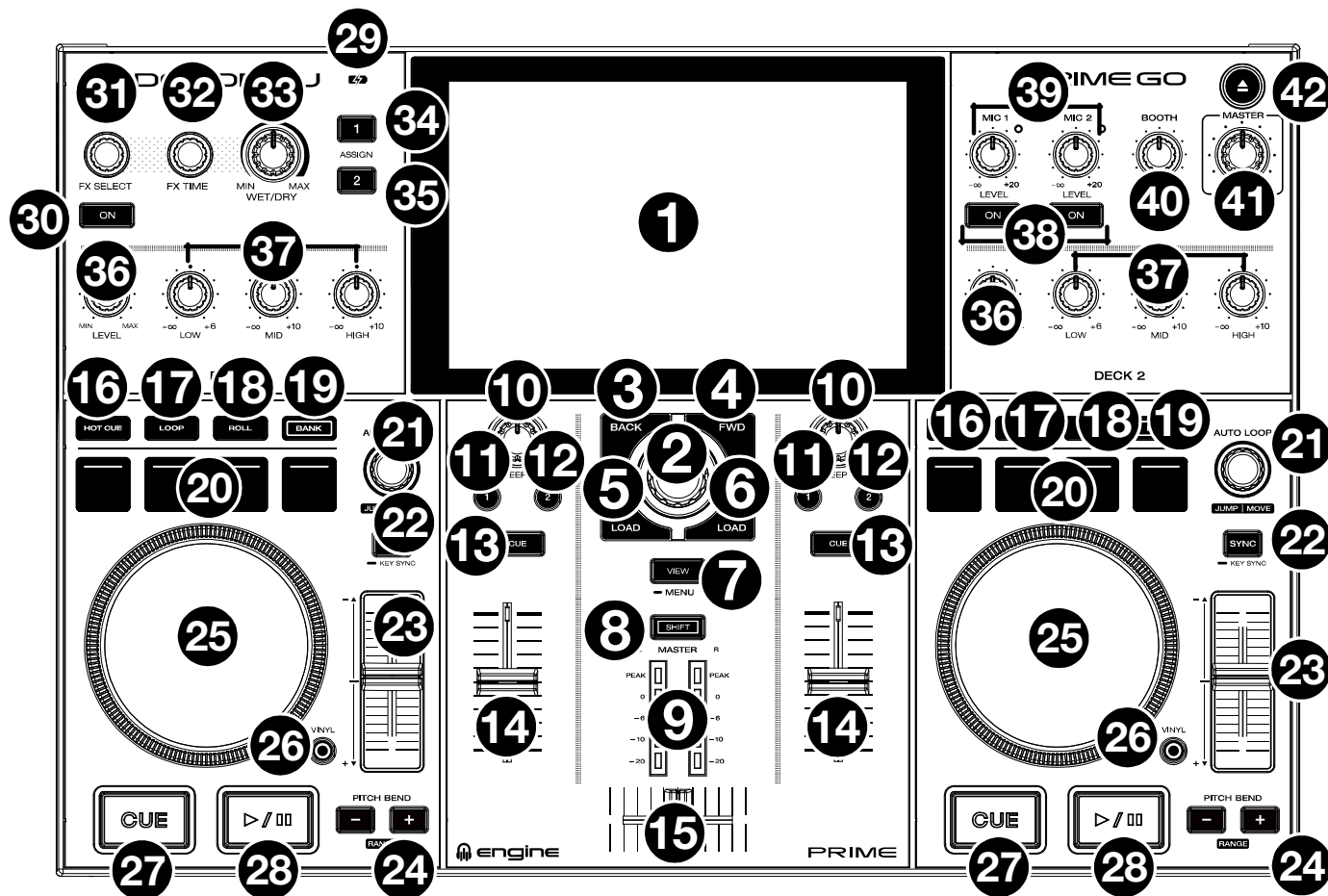

1. **Touchscreen:** This full-color, multi-touch display shows information relevant to PRIME GO's current operation. Touch the touchscreen (and use the hardware controls) to control the PRIME GO interface. See [Touchscreen Overview](#) for more information.

2. **Browse Knob:** Turn this knob to navigate through lists. Press the knob to move forward in the touchscreen or select a song to load on either deck.

Hold **Shift** and press the **Browse** knob to add a track to the Prepare list.

3. **Back:** While in Library View, press this button to move to the previous window. While in Performance View, press this button to enter Library View.

4. **Forward (FWD):** While in Library View, press this button to move to the next window. While in Performance View, press this button to enter Library View.

Hold **Shift** and press **FWD** to turn **Quantize** on/off.

5. **Load ◀:** Press this button to load the selected track to Deck 1.

Quickly double-press this button to instant double the track currently playing on Deck 2 to Deck 1.

6. **Load ▶:** Press this button to load the selected track to Deck 2. Quickly double-press this button to instant double the track currently playing on Deck 1 to Deck 2.

7. **View:** Press this button to cycle between [Library View](#) and [Performance View](#). Double-press this button to enter the [Engine Lighting](#) view.

Press and hold this button to show the Control Center, which includes quick links to other menus such as Source, Record, User Profile and Settings. See [Control Center](#) for more information.

Hold **Shift** and press the **View** button to switch between horizontal and vertical waveform views in Performance View.

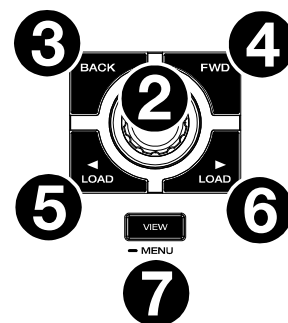

- 8. **Shift:** Press and hold this button to access secondary functions of other controls.
- 9. **Master Level Meters:** These LEDs display the audio signal level of the master mix (sent out of the **Master Outputs**).

10. **Sweep FX:** Turn this knob to control the active Sweep FX A or FX B. Available selections are Filter and Wash Out.

11. **Sweep FX A:** Press this button to activate Sweep FX A (**Filter**). This effect applies a filter to the channel. Starting from the center (12:00) position, turn a **Sweep FX knob** counter-clockwise to apply a low-pass filter, or turn it clockwise to apply a high-pass filter.

12. **Sweep FX B:** Press this button to activate Sweep FX B (**Wash Out**). This creates a transition effect. Turn a **Sweep FX knob** to its most counter-clockwise (minimum) position to apply a 1-beat echo that will also mute the channel's normal audio signal, or turn it to its most clockwise (maximum) position to apply a 1/2-beat echo.

13. **Channel Cue:** Press this button to send the channel's pre-fader signal to the headphones' cue channel.

14. **Channel Fader:** Use this fader to adjust the channel's volume level.

15. **Crossfader:** Use the crossfader to mix between Deck 1 and Deck 2.

16. **Hot Cue:** Press this button to enter Hot Cue Mode.

17. **Loop:** Press this button once to enter Manual Loop Mode and press it again to enter Auto Loop Mode.

18. **Roll:** Press this button to enter Roll Mode.

Press and hold **Shift** and then press this button to enter Sampler Mode.

19. **Bank:** This button is used to change the value of the 4 performance pads. The button will blink while accessing pads 5-8.

20. **Performance Pads:** These pads have different functions on each deck depending on the current pad mode. See [Pad Modes](#) for more information.

21. **Auto Loop:** Turn this knob to set the size of an automatic loop. The value will be shown in the touchscreen.

Press this knob to activate or deactivate an automatic loop at the current location of the track.

Jump/Move: Press and hold **Shift** and turn this knob to shift the active loop to the left or right (Loop Move). When the loop is inactive, press and hold **Shift** and turn this knob to jump forward or backward in the track by a pre-determined quantized value (Beat Jump).

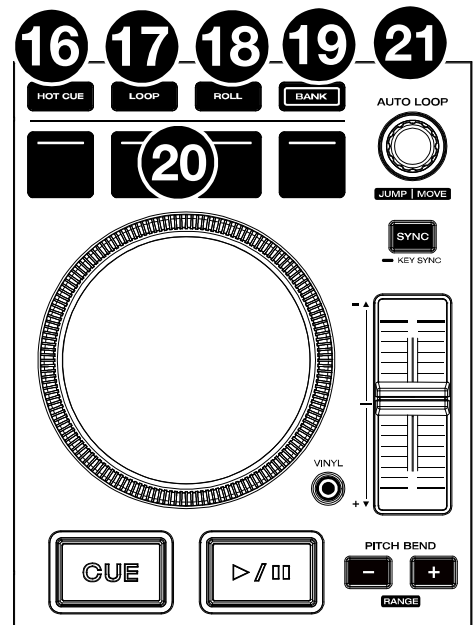
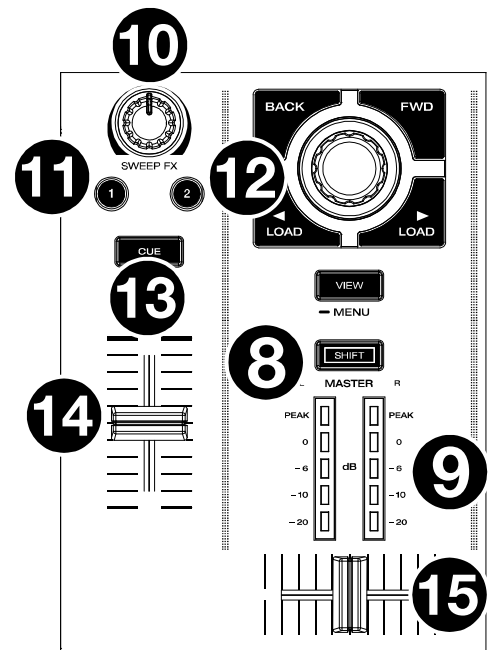

22. **Sync:** Press this button to activate sync. When Key Lock is activated, the track's key will remain the same even if you adjust its speed.

Key Sync: When a track is playing back, press and hold this button to activate key sync to that track.

23. **Pitch Fader:** Move this fader to adjust the speed (pitch) of the track.

24. **Pitch Bend -/+:** Press and hold one of these buttons to momentarily reduce or increase (respectively) the speed of the track.

Press and hold **Shift** and then press one of these buttons to set the range of the **pitch fader**.

25. **Platter:** This capacitive, touch-sensitive platter controls the audio playhead when the wheel is touched and moved.

26. **Vinyl:** Press this button to activate/deactivate a "vinyl mode" for the platter. When activated, you can use the **platter** to "scratch" the track as you would with a vinyl record. When deactivated (or if you are touching only the side of the **platter**), move the **platter** to temporarily adjust the track's speed.

Press and hold **Vinyl** to enter/exit Grid Edit Mode.

Press and hold **Shift** and then press and hold this button to manually adjust cue/loop point locations left or right using the **touchscreen** controls.

27. **Cue:** During playback, press this button to return the track to the initial cue point and stop playback. To move the initial cue point, make sure the track is paused, move the platter to place the audio playhead at the desired location, and then press this button. If the deck is paused, press and hold this button to temporarily play the track from the initial cue point. Release the button to return the track to the initial cue point and pause it. To continue playback without returning to the initial cue point, press and hold this button and then press and hold the Play button, and then release both buttons.

During playback, press and hold **Shift** and then press this button to set the initial cue point at the current playhead position.

28. **Play/Pause:** This button pauses or resumes playback.

Press and hold **Shift** and then press this button to "stutter-play" the track from the initial cue point.

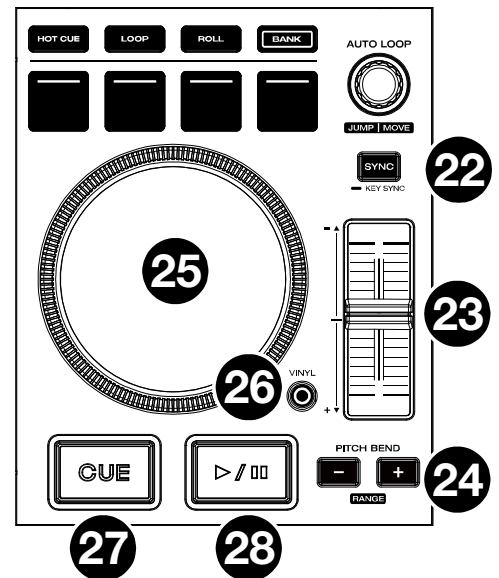



29. **Battery Charging Indicator:** This LED is solid green while charging. When charging is complete, the LED will turn off.
30. **FX On:** Press this button to enable or disable the selected effect.
Hold **Shift** and press **FX On** to show or hide the FX bar.
31. **FX Select:** Turn this knob to select the active effect for FX 1 and FX 2.
32. **FX Time:** Turn this knob to decrease or increase the rate of time-based effects on that deck.
Press this knob to toggle between FX Time and FX Parameter control, and then turn the knob to adjust the parameter.
33. **FX Wet/Dry Knob:** Turn this knob to adjust the wet/dry mix of the effects.
34. **FX Assign 1:** Press this button to assign effect routing to Deck 1.
35. **FX Assign 2:** Press this button to assign effect routing to Deck 2.
36. **Channel Level:** Turn this knob to adjust the level of the pre-fader, pre-EQ audio signal for the channel.
37. **Channel EQ:** Turn these knobs to boost or cut the low, mid-range, and high frequencies for the channel.
38. **Mic On/Off:** Press this button to toggle the microphone signal on/off.
Hold **Shift** and press **Mic On/Off** for Mic 1 to turn **Talkover** on/off, which automatically reduces the volume level of the master mix when you speak into the microphone.
39. **Mic Level:** Turn these knobs to adjust the volume levels of the corresponding microphone inputs. The **Peak** light next to each knob indicates the current signal level by its color: **green** (low), **amber** (normal/optimal), or **red** (maximum/peak). You can adjust the microphone attenuation in the **Settings** menu.
- Important:** The audio signals from the microphones are routed directly to the **Master Outputs**.
40. **Booth Level:** Turn this knob to adjust the volume level of the **Booth Outputs**.
41. **Master Level:** Turn this knob to adjust the volume level of the **Master Outputs**.
42. **Eject:** Press this button to display a list of connected media devices on the touchscreen. Tap one of the listed media sources to eject that device.
Hold **Shift** and press this button to open the **Source** menu.

Front Panel

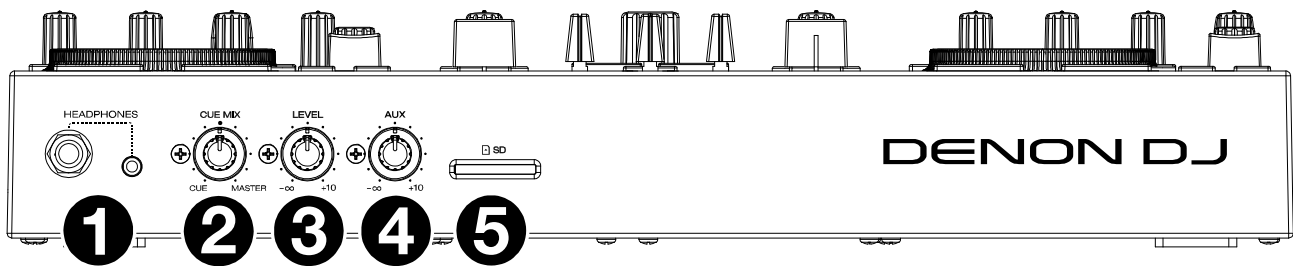

1. **Headphones (1/4", 1/8") (6.35 mm, 3.5 mm):** Connect your 1/4" or 1/8" (6.35 mm or 3.5 mm) headphones to this output for cueing and mix monitoring. The headphone volume is controlled using the **Phones Level** knob.
 2. **Cue Mix:** Turn this knob to adjust the blend of the pre-fader and master channels together in the headphones.
 3. **Phones Level:** Turn this knob to adjust the volume level in your headphones.
 4. **Aux Level:** Turn this knob to adjust the volume level of the **Aux input**.
- Note:** The Auxiliary input signal is only sent to the **Master Outputs**.
5. **SD Card Slot:** Insert a standard SD card to this slot. You can use the touchscreen to select and load tracks from your SD card.

Rear Panel

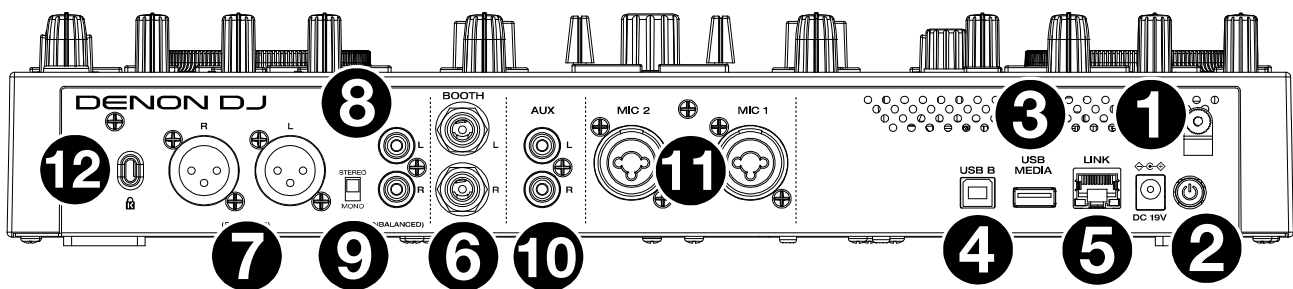

1. **Power Input:** Use the included power adapter to power the unit or charge the internal lithium-ion battery.
2. **Power Button:** Press this button to power PRIME GO on. Power on PRIME GO only **after** you have connected all your input devices and **before** you power on your amplifiers and loudspeakers.
To power off PRIME GO, press this button and follow the prompts on the touchscreen. Power off your amplifiers and loudspeakers **before** powering off PRIME GO.
3. **USB Media:** Connect a standard USB drive to this USB port. When you select a USB drive as a source, you can use the touchscreen to select and load tracks from your USB drive.
4. **USB B:** Use a standard USB cable (included) to connect this USB port to an available USB port on your computer.
5. **Link Port:** Use a standard Ethernet cable to connect this port to a computer. PRIME GO will send time, BPM, and other track data to the compatible StagelinQ lighting and video software over this connection.
6. **Booth Outputs (1/4" / 6.35 mm):** Use standard 1/4" (6.35 mm) cables to connect these outputs to booth monitors or a booth amplifier system. Use the **Booth Level** knob on the top panel to control the volume level.
7. **Master Outputs (XLR, balanced):** Use standard XLR cables to connect these outputs to loudspeakers or an amplifier system. Use the **Master Level** knob on the top panel to control the volume level.
8. **Master Outputs (RCA, unbalanced):** Use standard RCA cables to connect these outputs to loudspeakers or an amplifier system. Use the **Master Level** knob on the top panel to control the volume level.
9. **Stereo/Mono:** Use this switch to set the channel configuration of the **Master Outputs: Stereo** (binaural audio using separate left and right channels) or **Mono** (summed monaural audio through both left and right channels).
10. **Aux Inputs (RCA, unbalanced):** Use standard RCA cables to connect these line-level inputs to an external audio source. Use the **Aux Level** knob on the top panel to control the volume level.
11. **Mic Inputs (XLR or 1/4" / 6.35 mm):** Use standard XLR or 1/4" (6.35 mm) cables (not included) to connect standard dynamic microphones to these inputs. Use the **Mic 1** and **Mic 2 Level** knobs on the top panel to control the volume level.
12. **Kensington® Lock Slot:** Use this slot to secure PRIME GO to a table or other surface.

SC LIVE 4

Top Panel

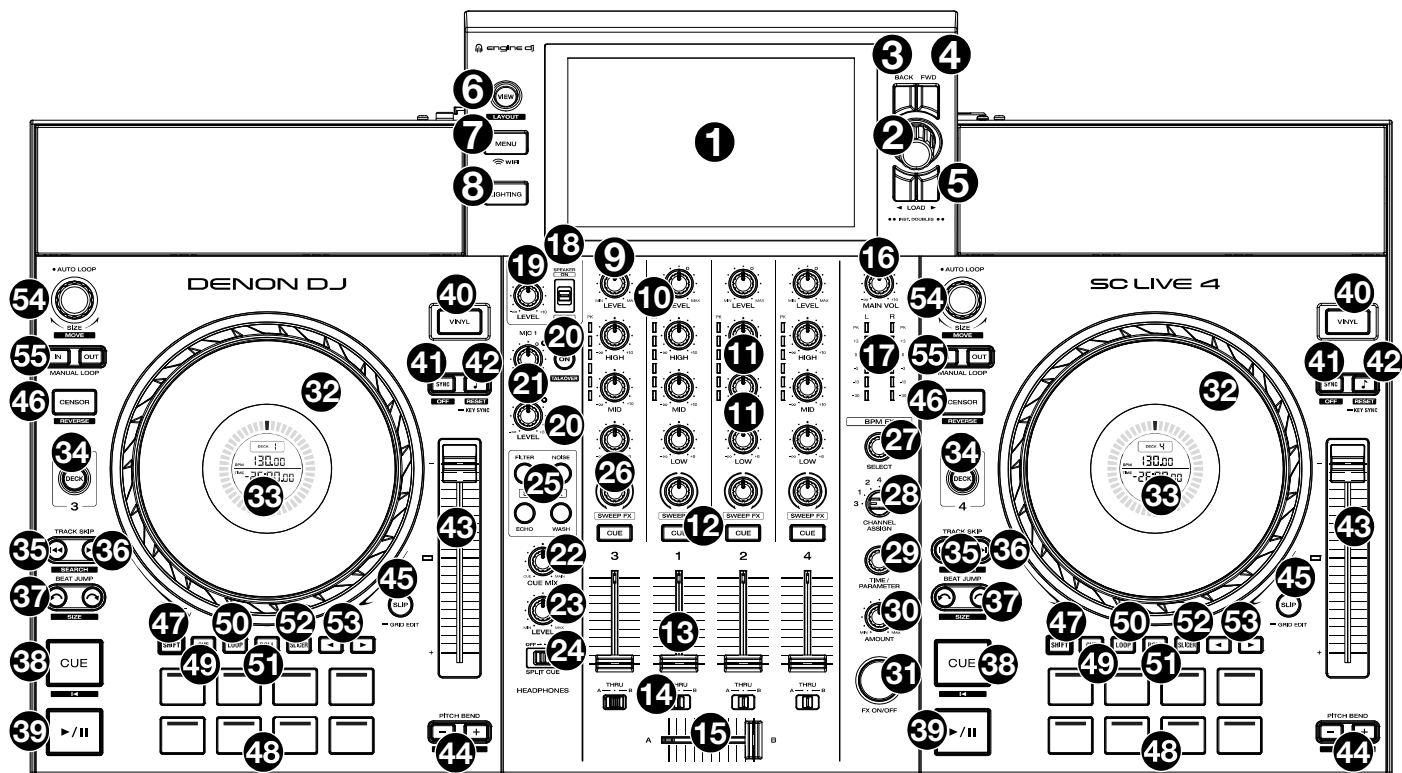

1. **Touchscreen:** This full-color, multi-touch display shows information relevant to SC LIVE 4's current operation. Touch the touchscreen (and use the hardware controls) to control the SC LIVE 4 interface. See [Touchscreen Overview](#) for more information.
2. **Browse Knob:** Turn this knob to navigate through lists. Press the knob to move forward in the touchscreen or select a song to load on either deck.

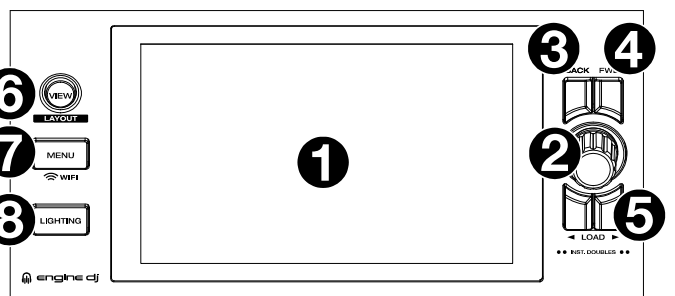

Hold **Shift** and press the **Browse** knob to add a track to the Prepare list.

3. **Back:** While in Library View, press this button to move to the previous window. While in Performance View, press this button to enter Library View.
4. **Forward (FWD):** While in Library View, press this button to move to the next window. While in Performance View, press this button to enter Library View.
Hold **Shift** and press **FWD** to turn **Quantize** on/off.
5. **Load ◀▶:** Press these buttons to load the selected track to Deck 1 or Deck 2.
Quickly double-press either button to instantly double the track currently playing from one deck to the other deck.
6. **View:** Press this button to cycle between [Library View](#) and [Performance View](#).
Hold **Shift** and press the **View** button to switch between horizontal and vertical waveform views in Performance View.
7. **Menu:** Press and hold this button to show the Control Center, which includes quick links to other menus such as Source, Record, User Profile, Wi-Fi, and Settings. See [Control Center](#) for more information.
8. **Lighting:** Press this button to enter the [Engine Lighting](#) view.
9. **Channel Level:** Turn this knob to adjust the level of the pre-fader, pre-EQ audio signal for the channel.
10. **Channel Level Meters:** These LEDs display the audio signal level for the channels.

11. **Channel EQ:** Turn these knobs to boost or cut the low, mid-range, and high frequencies for the channel.
12. **Channel Cue:** Press this button to send the channel's pre-fader signal to the headphones' cue channel.
13. **Channel Faders:** Use these faders to adjust the channel's volume level.
14. **Crossfader Assign:** Routes the audio playing on the corresponding channel to either side of the crossfader (**A** or **B**), or bypasses the crossfader and sends the audio directly to the program mix (center, **Thru**).
15. **Crossfader:** Use the crossfader to mix between Deck A and Deck B.
16. **Main Volume:** Turn this knob to adjust the volume level of the **Main Outputs**.
17. **Main Level Meters:** These LEDs display the audio signal level of the overall mix (sent out of the **Main Outputs**).
18. **Speaker:** Mutes or unmutes the internal speakers.
19. **Speaker/Booth Level:** Adjusts the volume of the internal speakers and **Booth Output**.
20. **Talkover:** Press this button to turn talkover on or off, which automatically reduces the volume level of the master mix when you speak into the microphone.

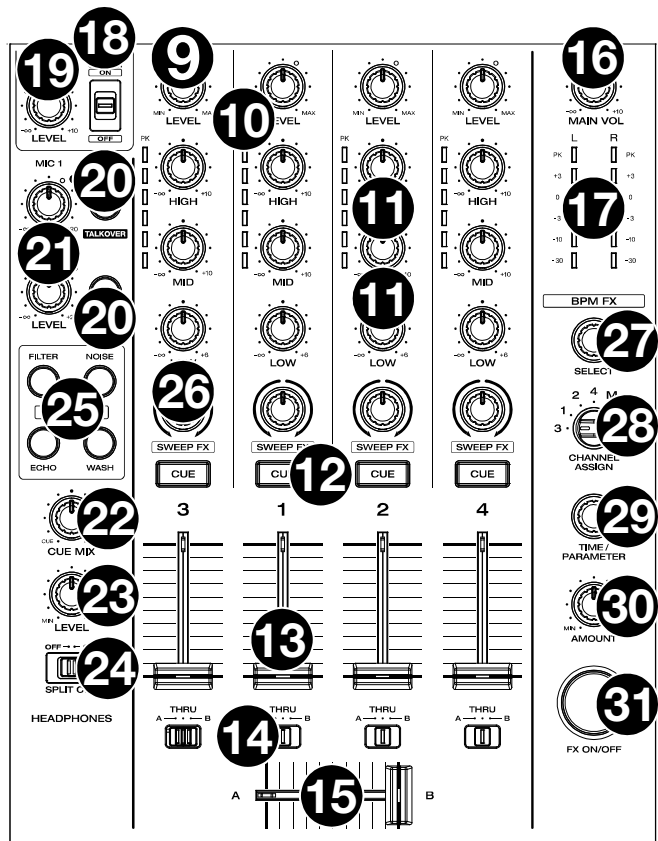

21. **Mic 1 / Aux/Mic 2 Level:** Turn this knob to adjust the volume level for the **Microphone 1-2** and **Aux** inputs. The **Peak** light next to each knob indicates the current signal level by its color: **green** (low), **amber** (normal/optimal), or **red** (maximum/peak). You can adjust additional microphone and aux settings in the **Settings** menu.
22. **Cue Mix:** Turn this knob to adjust the blend of the pre-fader and main mix together in the headphones.
23. **Headphones Level:** Turn this knob to adjust the volume of the cue level in the headphones.
24. **Split Cue:** When this switch is **On**, the headphone audio will be “split” such that all channels sent to cue channel are summed to mono and sent to the left headphone channel and the master mix is summed to mono and sent to the right channel. When this switch is **Off**, the cue channel and main mix will be “blended” together. You can swap the left/right position of these channels in the **Settings** menu.
25. **Sweep FX:** Press these buttons to select the active Sweep FX. The available selections are:
 - **Filter:** This effect applies a filter to the channel. Starting from the center (12:00) position, turn a **Sweep FX knob** counter-clockwise to apply a low-pass filter, or turn it clockwise to apply a high-pass filter.
 - **Noise:** This effect adds noise to the signal. Starting from the center (12:00) position, turn a **Sweep FX knob** counterclockwise to add pink noise, or turn it clockwise to add white noise.
 - **Echo:** This effect is a brief echo. Starting from the center (12:00) position, turn a **Sweep FX knob** counterclockwise to decrease the length of the delay and increase the feedback, or turn it clockwise to increase the length of the delay as well as the feedback.
 - **Wash Out:** This creates a transition effect. Turn a **Sweep FX knob** to its most counter-clockwise (minimum) position to apply a 1-beat echo that will also mute the channel's normal audio signal, or turn it to its most clockwise (maximum) position to apply a 1/2-beat echo.
26. **Sweep FX A/B:** Turn these knobs to control the active Sweep FX A or FX B.
27. **BPM FX Select:** Turn this knob to select the active effect for FX 1 and FX 2.
28. **BPM FX Channel Assign:** Adjust this switch to assign effect routing from Deck 1, Deck 2, Deck 3, Deck 4, or the Main Outputs.
29. **BPM FX Time/Parameter:** Turn this knob to decrease or increase the rate of time-based effects on that deck. Press this knob to toggle between FX Time and FX Parameter control, and then turn the knob to adjust the parameter.
Press and hold **Shift** and press this knob to reset the effect parameter to its default settings.
30. **BPM FX Amount:** Turn this knob to adjust the wet/dry mix of the effects.
31. **BPM FX On/Off:** Press this button to enable or disable the selected effect.

32. **Platter:** This capacitive, touch-sensitive platter controls the audio playhead when the wheel is touched and moved.

33. **Jog Display:** This display shows information relevant to the performance, including the current playhead position, active deck, and track BPM. See [Jog Display](#) below for more information.

34. **Deck:** Selects which deck in the software is controlled by that hardware deck. The left deck can control Deck 1 or 3; the right deck can control Deck 2 or 4.

Press and hold **Shift** and then press the Deck 3 or Deck 4 buttons to switch between four-deck and two-deck operation.

35. **Track Skip Back:** Press this button to skip to the previous track.

Press this button in the middle of a paused track to return to the beginning of the track.

Press and hold **Shift** and this button to search backward through the track.

36. **Track Skip Forward:** Press this button to skip to the next track.

Press this button in the middle of a paused track to go to the next track.

Press and hold **Shift** and then press one of these buttons to search forward through the track.

37. **Beat Jump:** Press either of these buttons to skip backward or forward through the track.

Press and hold **Shift** and press one of these buttons to increase or decrease the beat jump size.

38. **Cue:** During playback, press this button to return the track to the initial cue point and stop playback. To move the initial cue point, make sure the track is paused, move the platter to place the audio playhead at the desired location, and then press this button.

If the deck is paused, press and hold this button to temporarily play the track from the initial cue point. Release the button to return the track to the initial cue point and pause it. To continue playback without returning to the initial cue point, press and hold this button and then press and hold the Play button, and then release both buttons.

During playback, press and hold **Shift** and then press this button to set the initial cue point at the current playhead position.

39. **Play/Pause:** This button pauses or resumes playback.

Press and hold **Shift** and then press this button to “stutter-play” the track from the initial cue point.

40. **Vinyl:** Press this button to activate/deactivate a “vinyl mode” for the platter. When activated, you can use the **platter** to “scratch” the track as you would with a vinyl record. When deactivated (or if you are touching only the side of the **platter**), move the **platter** to temporarily adjust the track’s speed.

41. **Sync:** Press this button to activate sync. When Key Lock is activated, the track’s key will remain the same even if you adjust its speed.

Press and hold **Shift** and press this button to turn off key lock.

42. **Key Sync:** When a track is playing back, press and hold this button to activate key sync to that track.

Press and hold **Shift** and press this button to reset to the track’s original key.

43. **Pitch Fader:** Move this fader to adjust the speed (pitch) of the track.

44. **Pitch Bend -/+:** Press and hold one of these buttons to momentarily reduce or increase (respectively) the speed of the track.

Press and hold **Shift** and then press one of these buttons to set the range of the **pitch fader**.

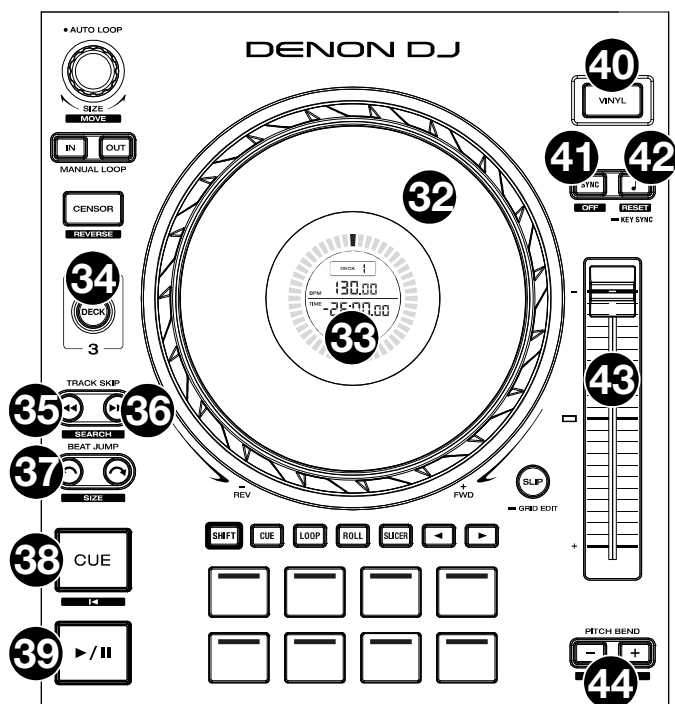

- 45. **Slip:** Press this button to enable or disable Slip Mode. In Slip Mode, you can jump to cue points, trigger loop rolls, or use the platters, while the track’s timeline continues. In other words, when you stop the action, the track will resume normal playback from where it would have been if you had never done anything (i.e., as if the track had been playing forward the whole time).

Press and hold **Shift** and then press this button to enable beat grid editing.

Press and hold **Shift** and then press this button while beat grid editing is enabled to reset the beat grid.

Press and hold **Shift** and then press and hold this button while beat grid editing is disabled to manually adjust cue/loop point locations left or right using the **touchscreen** controls.

- 46. **Censor / Reverse:** Press this button to activate/deactivate the Censor feature: the playback of the track will be reversed, but when you release the button, normal playback will resume from where it would have been if you had never engaged the Censor feature (i.e., as if the track had been playing forward the whole time).

Press and hold **Shift** and then press this button to reverse the playback of the track normally.

- 47. **Shift:** Press and hold this button to access secondary functions of other controls.
- 48. **Performance Pads:** These pads have different functions on each deck depending on the current pad mode. See [Pad Modes](#) for more information.
- 49. **Hot Cue:** Press this button to enter Hot Cue Mode.
- 50. **Loop:** Press this button once to enter Manual Loop Mode, and press it again to enter Auto Loop mode.
- 51. **Roll:** Press this button to enter Roll Mode.
Press and hold **Shift** and then press this button to enter Sampler Mode.
- 52. **Slicer:** Press this button once to enter Slicer Mode, and press it again to enter Slicer Loop Mode.
- 53. **Parameter ◀/▶:** Use these buttons for various functions in certain Pad Modes. See [Pad Modes](#) for more information.
- 54. **Auto Loop / Loop Move:** Turn this knob to set the size of an automatic loop. The value will be shown in the touchscreen and platter display.
Press this knob to activate or deactivate an automatic loop at the current location of the track.
Press and hold **Shift** and turn this knob to shift the active loop to the left or right.
- 55. **Loop In / Loop Out:** Press either of these buttons to create a Loop In or Loop Out point at the current location. Their placement will be affected by the **Quantize** and **Smart Loops** settings. See [Looping & Beat-Jumping](#) for more information.
Press and hold **Shift** and press either of these buttons to manually adjust the loop in and out points.

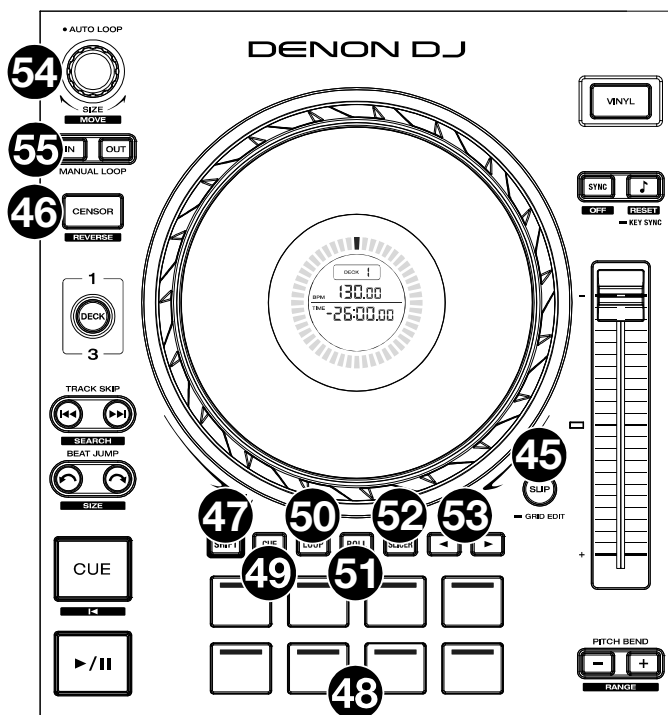

Jog Display

1. **Playhead Position:** Indicates the current position of the playhead.
2. **Selected Deck:** Shows the active deck.
3. **BPM:** Shows the BPM of the track loaded to the active deck.
4. **Track Time:** Shows the elapsed or remaining time for the track. Tracks shorter than one hour will be shown as MM:SS:ss. Tracks longer than one hour will be shown as HH:MM with an “HR” label next to the time.

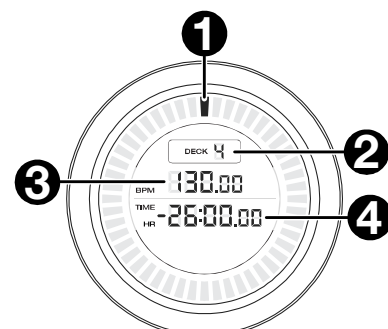

Front Panel

1. **Headphones (1/4", 1/8") (6.35 mm, 3.5 mm):** Connect your 1/4" or 1/8" (6.35 mm or 3.5 mm) headphones to this output for cueing and mix monitoring. The headphone volume is controlled using the **Headphones Level** knob.

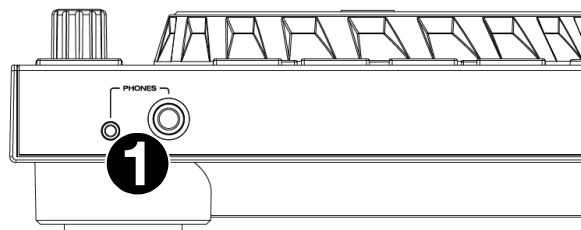

Rear Panel

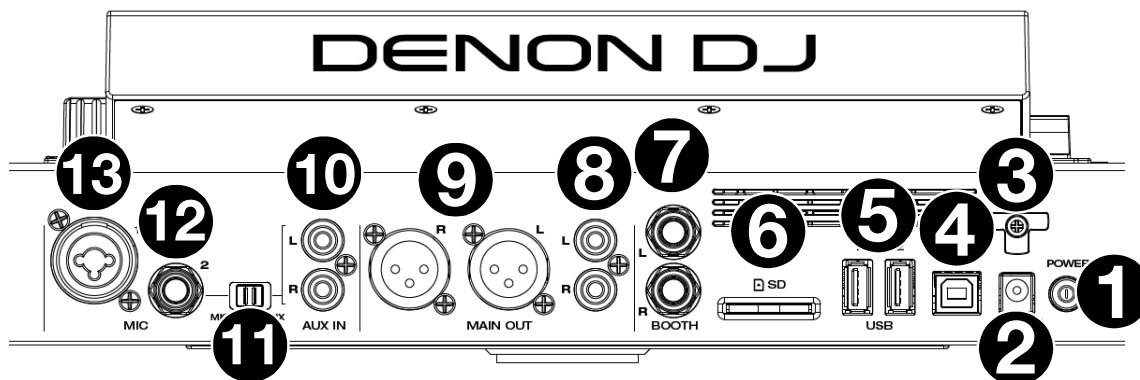

1. **Power Button:** Press this button to power SC LIVE 4 on. Power on SC LIVE 4 only **after** you have connected all your input devices and **before** you power on your amplifiers and loudspeakers.
To power off SC LIVE 4, press this button and follow the prompts on the touchscreen. Power off your amplifiers and loudspeakers **before** powering off SC LIVE 4.
2. **Power Input:** Use the included power adapter to power the unit.
3. **Power Cable Support:** Wrap the power cable here for added support.
4. **USB-B Port:** Use a standard USB cable (included) to connect this USB port to an available USB port on your computer.
5. **USB-A Ports 1–2:** Connect standard USB drives to these USB ports. When you select a USB drive as a source, you can use the touchscreen to select and load tracks from your USB drive.
6. **SD Card:** Insert a standard SD card to this slot. When you select that SD card as a source, you can use the display to select and load tracks on your SD card.
7. **Booth Outputs (1/4" / 6.35 mm):** Use standard 1/4" (6.35 mm) cables to connect these outputs to booth monitors or a booth amplifier system. Use the **Speaker/Booth Level** knob on the top panel to control the volume level.
8. **Main Outputs (RCA, unbalanced):** Use standard RCA cables to connect these outputs to loudspeakers or an amplifier system. Use the **Main Volume** knob on the top panel to control the volume level.
9. **Main Outputs (XLR, balanced):** Use standard XLR cables to connect these outputs to loudspeakers or an amplifier system. Use the **Main Volume** knob on the top panel to control the volume level.
10. **Aux Input (RCA, unbalanced):** Use standard RCA cables to connect these line-level inputs to an external audio source. Set the **Mic 2/Aux** switch to **Aux** and then use the **Aux/Mic 2 Level** knob on the top panel to control the volume level.
11. **Mic 2/Aux:** Use this switch to select whether the **Mic 2 Input** or **Aux Input** is active.
12. **Microphone 1 Input (XLR):** Use a standard XLR cable (not included) to connect a standard dynamic microphone to this input. Use the **Mic 1 Level** knob on the top panel to control the volume level.
13. **Microphone 2 Input (1/4" / 6.35 mm):** Use a standard 1/4" (6.35 mm) cable (not included) to connect a standard dynamic microphone to this input. Set the **Mic 2/Aux** switch to **Mic 2** and then use the **Aux/Mic 2 Level** knob on the top panel to control the volume level.

SC LIVE 2

Top Panel

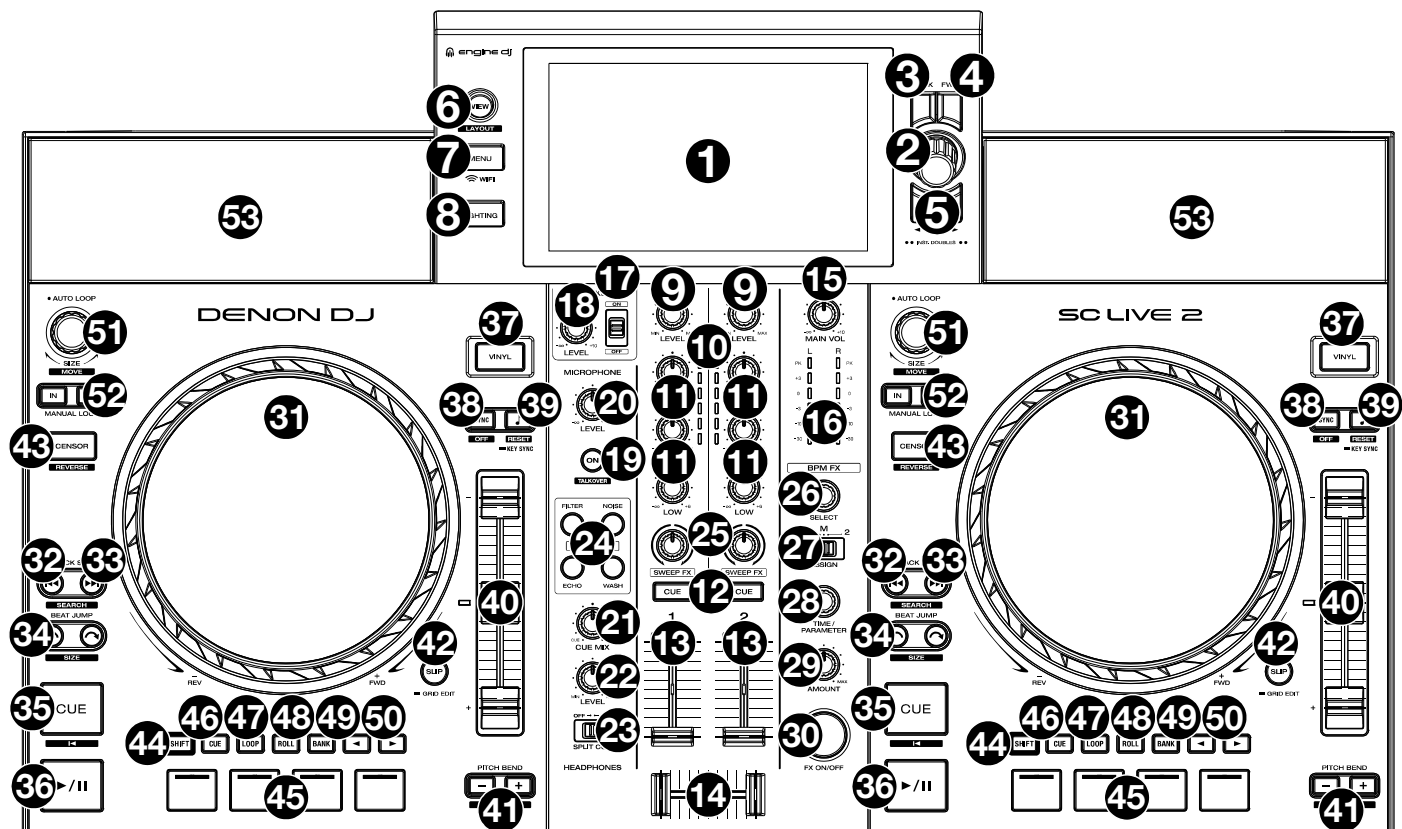

1. **Touchscreen:** This full-color, multi-touch display shows information relevant to SC LIVE 2's current operation. Touch the touchscreen (and use the hardware controls) to control the SC LIVE 2 interface. See [Touchscreen Overview](#) for more information.

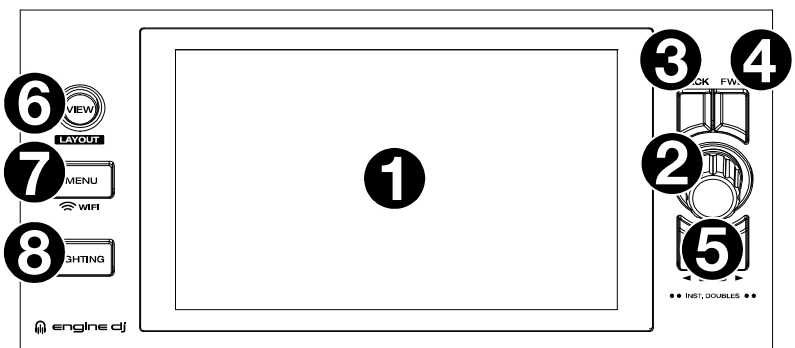

2. **Browse Knob:** Turn this knob to navigate through lists. Press the knob to move forward in the touchscreen or select a song to load on either deck.

Hold **Shift** and press the **Browse** knob to add a track to the Prepare list.

3. **Back:** While in Library View, press this button to move to the previous window. While in Performance View, press this button to enter Library View.

4. **Forward (FWD):** While in Library View, press this button to move to the next window. While in Performance View, press this button to enter Library View.

Hold **Shift** and press **FWD** to turn **Quantize** on/off.

5. **Load ◀/▶:** Press these buttons to load the selected track to Deck 1 or Deck 2.

Quickly double-press either button to instantly double the track currently playing from one deck to the other deck.

6. **View:** Press this button to cycle between [Library View](#) and [Performance View](#).

Hold **Shift** and press the **View** button to switch between horizontal and vertical waveform views in Performance View.

7. **Menu:** Press and hold this button to show the Control Center, which includes quick links to other menus such as Source, Record, User Profile, Wi-Fi, and Settings. See [Control Center](#) for more information.

8. **Lighting:** Press this button to enter the [Engine Lighting](#) view.

9. **Channel Level:** Turn this knob to adjust the level of the pre-fader, pre-EQ audio signal for the channel.
10. **Channel Level Meters:** These LEDs display the audio signal level for the channels.
11. **Channel EQ:** Turn these knobs to boost or cut the low, mid-range, and high frequencies for the channel.
12. **Channel Cue:** Press this button to send the channel's pre-fader signal to the headphones' cue channel.
13. **Channel Fader:** Use this fader to adjust the channel's volume level.
14. **Crossfader:** Use the crossfader to mix between Deck 1 and Deck 2.
15. **Main Volume:** Turn this knob to adjust the volume level of the **Main Outputs**.
16. **Main Level Meters:** These LEDs display the audio signal level of the overall mix (sent out of the **Main Outputs**).
17. **Speaker:** Mutes or unmutes the internal speakers.
18. **Speaker Level:** Adjusts the internal speakers volume.
19. **Talkover:** Press to turn talkover on or off, which automatically reduces the volume level of the master mix when you speak into the microphone.

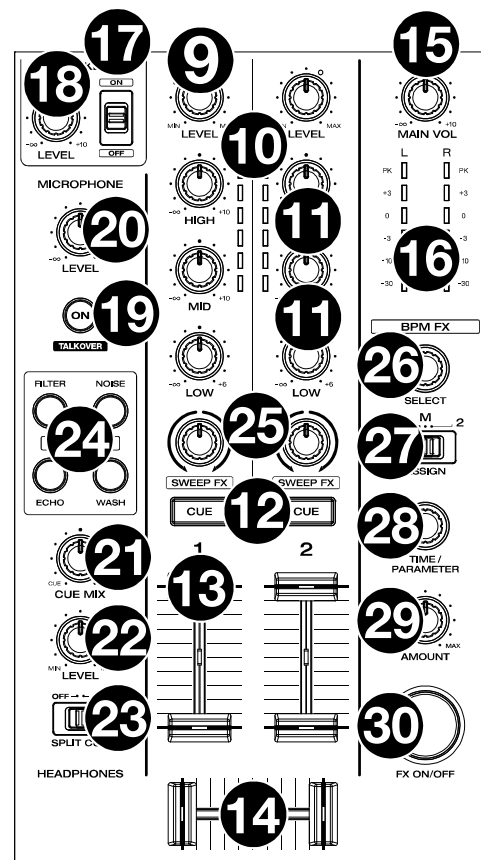

20. **Microphone Level:** Turn this knob to adjust the volume level for the microphone input. The **Peak** light next to the knob indicates the current signal level by its color: **green** (low), **amber** (normal/optimal), or **red** (maximum/peak). You can adjust additional microphone settings in the **Settings** menu.
21. **Cue Mix:** Turn this knob to adjust the blend of the pre-fader and main mix together in the headphones.
22. **Headphones Level:** Turn this knob to adjust the volume of the cue level in the headphones.
23. **Split Cue:** When this switch is **On**, the headphone audio will be “split” such that all channels sent to cue channel are summed to mono and sent to the left headphone channel and the master mix is summed to mono and sent to the right channel. When this switch is **Off**, the cue channel and main mix will be “blended” together. You can swap the left/right position of these channels in the **Settings** menu.
24. **Sweep FX:** Press these buttons to select the active Sweep FX. The available selections are:
 - **Filter:** This effect applies a filter to the channel. Starting from the center (12:00) position, turn a **Sweep FX knob** counter-clockwise to apply a low-pass filter, or turn it clockwise to apply a high-pass filter.
 - **Noise:** This effect adds noise to the signal. Starting from the center (12:00) position, turn a **Sweep FX knob** counterclockwise to add pink noise, or turn it clockwise to add white noise.
 - **Echo:** This effect is a brief echo. Starting from the center (12:00) position, turn a **Sweep FX knob** counterclockwise to decrease the length of the delay and increase the feedback, or turn it clockwise to increase the length of the delay as well as the feedback.
 - **Wash Out:** This creates a transition effect. Turn a **Sweep FX knob** to its most counter-clockwise (minimum) position to apply a 1-beat echo that will also mute the channel's normal audio signal, or turn it to its most clockwise (maximum) position to apply a 1/2-beat echo.
25. **Sweep FX Knobs:** Turn these knobs to control the active Sweep FX.
26. **BPM FX Select:** Turn this knob to select the active effect for BPM FX.
27. **BPM FX Assign:** Adjust this switch to assign BPM effect routing to Deck 1, Deck 2, or the Main Output.
28. **BPM FX Time/Parameter:** Turn this knob to decrease or increase the rate of time-based effects on that deck. Press this knob to toggle between BPM FX Time and BPM FX Parameter control, and then turn the knob to adjust the parameter.
Press and hold **Shift** and press this knob to reset the effect parameter to its default settings.
29. **BPM FX Amount:** Turn this knob to adjust the wet/dry mix of the BPM effects.
30. **BPM FX On/Off:** Press this button to enable or disable the selected BPM effect.

31. **Platter:** This capacitive, touch-sensitive platter controls the audio playhead when the wheel is touched and moved.
32. **Track Skip Back:** Press this button to skip to the previous track.
Press this button in the middle of a paused track to return to the beginning of the track.
Press and hold **Shift** and this button to search backward through the track.
33. **Track Skip Forward:** Press this button to skip to the next track.
Press this button in the middle of a paused track to go to the next track.
Press and hold **Shift** and then press one of these buttons to search forward through the track.
34. **Beat Jump:** Press either of these buttons to skip backward or forward through the track.
Press and hold **Shift** and press one of these buttons to increase or decrease the beat jump size.

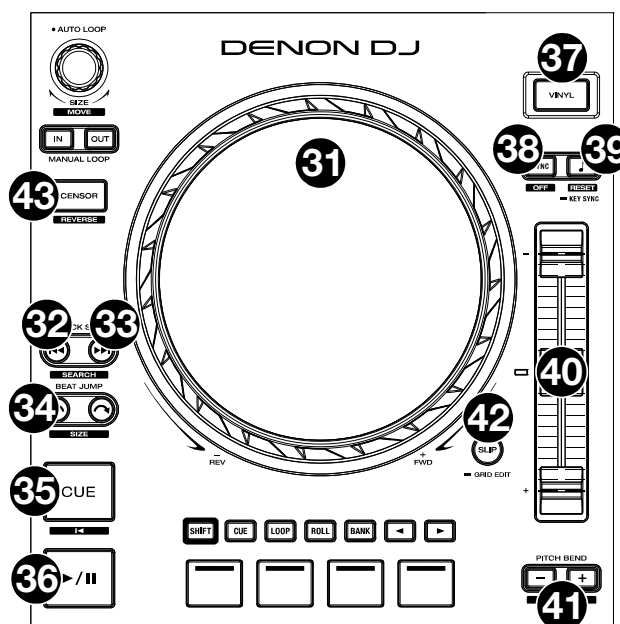

35. **Cue:** During playback, press this button to return the track to the initial cue point and stop playback. To move the initial cue point, make sure the track is paused, move the platter to place the audio playhead at the desired location, and then press this button. If the deck is paused, press and hold this button to temporarily play the track from the initial cue point. Release the button to return the track to the initial cue point and pause it. To continue playback without returning to the initial cue point, press and hold this button and then press and hold the Play button, and then release both buttons.
During playback, press and hold **Shift** and then press this button to set the initial cue point at the current playhead position.
36. **Play/Pause:** This button pauses or resumes playback.
Press and hold **Shift** and then press this button to “stutter-play” the track from the initial cue point.
37. **Vinyl:** Press this button to activate/deactivate a “vinyl mode” for the platter. When activated, you can use the **platter** to “scratch” the track as you would with a vinyl record. When deactivated (or if you are touching only the side of the **platter**), move the **platter** to temporarily adjust the track’s speed.
38. **Sync:** Press this button to activate sync. When Key Lock is activated, the track’s key will remain the same even if you adjust its speed.
Press and hold **Shift** and press this button to turn off key lock.
39. **Key Sync:** When a track is playing back, press and hold this button to activate key sync to that track.
Press and hold **Shift** and press this button to reset to the track’s original key.
40. **Pitch Fader:** Move this fader to adjust the speed (pitch) of the track.
41. **Pitch Bend –/+:** Press and hold one of these buttons to momentarily reduce or increase (respectively) the speed of the track.
Press and hold **Shift** and then press one of these buttons to set the range of the **pitch fader**.
42. **Slip:** Press this button to enable or disable Slip Mode. In Slip Mode, you can jump to cue points, trigger loop rolls, or use the platters, while the track’s timeline continues. In other words, when you stop the action, the track will resume normal playback from where it would have been if you had never done anything (i.e., as if the track had been playing forward the whole time).
Press and hold **Shift** and then press this button to enable beat grid editing.
Press and hold **Shift** and then press this button while beat grid editing is enabled to reset the beat grid.
Press and hold **Shift** and then press and hold this button while beat grid editing is disabled to manually adjust cue/loop point locations left or right using the **touchscreen** controls.
43. **Censor / Reverse:** Press this button to activate/deactivate the Censor feature: the playback of the track will be reversed, but when you release the button, normal playback will resume from where it would have been if you had never engaged the Censor feature (i.e., as if the track had been playing forward the whole time).
Press and hold **Shift** and then press this button to reverse the playback of the track normally.

44. **Shift:** Press and hold this button to access secondary functions of other controls.
45. **Performance Pads:** These pads have different functions on each deck depending on the current pad mode. See [Pad Modes](#) for more information.
46. **Hot Cue:** Press this button to enter Hot Cue Mode.
47. **Loop:** Press this button once to enter Manual Loop Mode, and press it again to enter Auto Loop mode.
48. **Roll:** Press this button to enter Roll Mode.

Press and hold **Shift** and then press this button to enter Sampler Mode.

49. **Bank:** This button is used to change the value of the 4 performance pads. The button will blink while accessing pads 5-8.
50. **Parameter** ◀/▶: Use these buttons for various functions in certain Pad Modes. See [Pad Modes](#) for more information.
51. **Auto Loop / Loop Move:** Turn this knob to set the size of an automatic loop. The value will be shown in the touchscreen and platter display.

Press this knob to activate or deactivate an automatic loop at the current location of the track.

Press and hold **Shift** and turn this knob to shift the active loop to the left or right.

52. **Loop In / Loop Out:** Press either of these buttons to create a Loop In or Loop Out point at the current location. Their placement will be affected by the **Quantize** and **Smart Loops** settings. See [Looping & Beat-Jumping](#) for more information.

Press and hold **Shift** and press either of these buttons to manually adjust the loop in and out points.

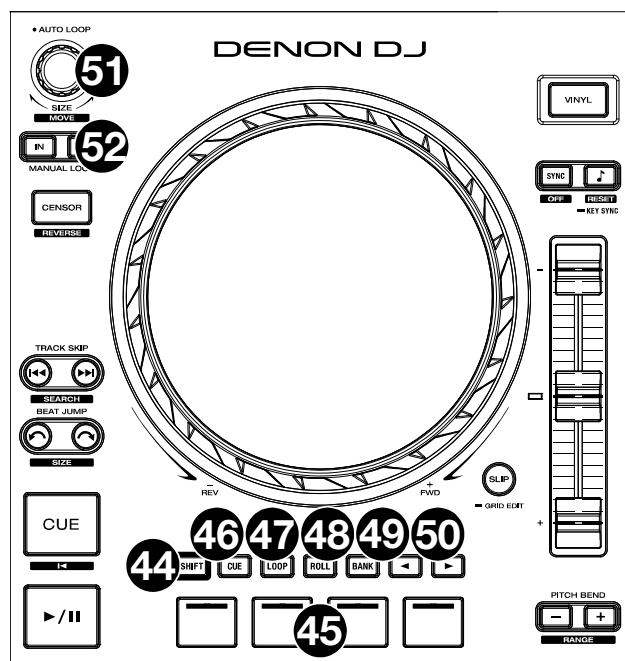

Front Panel

1. **Headphones (1/4", 1/8") (6.35 mm, 3.5 mm):** Connect your 1/4" or 1/8" (6.35 mm or 3.5 mm) headphones to this output for cueing and mix monitoring. The headphone volume is controlled using the **Headphones Level** knob.

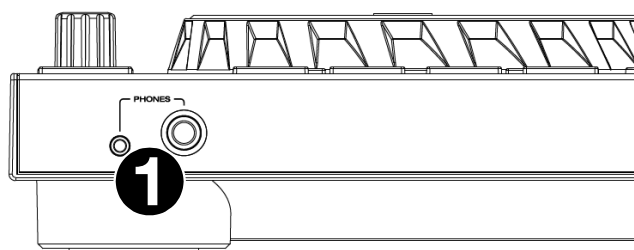

Rear Panel

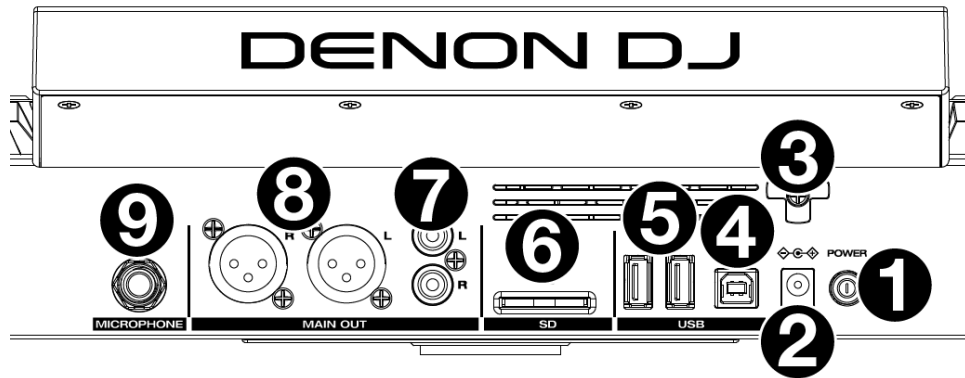

1. **Power Button:** Press this button to power SC LIVE 2 on. Power on SC LIVE 2 only **after** you have connected all your input devices and **before** you power on your amplifiers and loudspeakers.
To power off SC LIVE 2, press this button and follow the prompts on the touchscreen. Power off your amplifiers and loudspeakers **before** powering off SC LIVE 2.
2. **Power Input:** Use the included power adapter to power the unit.
3. **Power Cable Support:** Wrap the power cable here for added support.
4. **USB-B Port:** Use a standard USB cable (included) to connect this USB port to an available USB port on your computer.
5. **USB-A Ports 1-2:** Connect standard USB drives to these USB ports. When you select a USB drive as a source, you can use the touchscreen to select and load tracks from your USB drive.
6. **SD Card:** Insert a standard SD card to this slot. When you select that SD card as a source, you can use the display to select and load tracks on your SD card.
7. **Main Outputs (RCA, unbalanced):** Use standard RCA cables to connect these outputs to loudspeakers or an amplifier system. Use the **Main Volume** knob on the top panel to control the volume level.
8. **Main Outputs (XLR, balanced):** Use standard XLR cables to connect these outputs to loudspeakers or an amplifier system. Use the **Main Volume** knob on the top panel to control the volume level.
9. **Microphone Input (1/4" / 6.35 mm):** Use a standard 1/4" (6.35 mm) cable (not included) to connect a standard dynamic microphone to this input. Use the **Microphone Level** knob on the top panel to control the volume level.

Operation

Touchscreen Overview

Performance View

Track Overview & Waveform

Swipe left or right on the track overview to scan through the track while the track is paused.

Note: You can use this feature during playback if Needle Lock is **off**. If Needle Lock is **on**, stopping the platter with your hand or palm will allow you to swipe through the track overview. See [User Profile](#) to learn about Needle Lock.

Spread or pinch your fingers on a waveform to zoom in or out of it, respectively.

Tap the time to switch between the elapsed time and remaining time.

Tap the key when Key Lock is on to change the key.

Hold Shift and press View to toggle between vertical and horizontal waveforms. For PRIME 4 and SC LIVE 4, you can also toggle between two-deck and four-deck waveform views.

PRIME 4

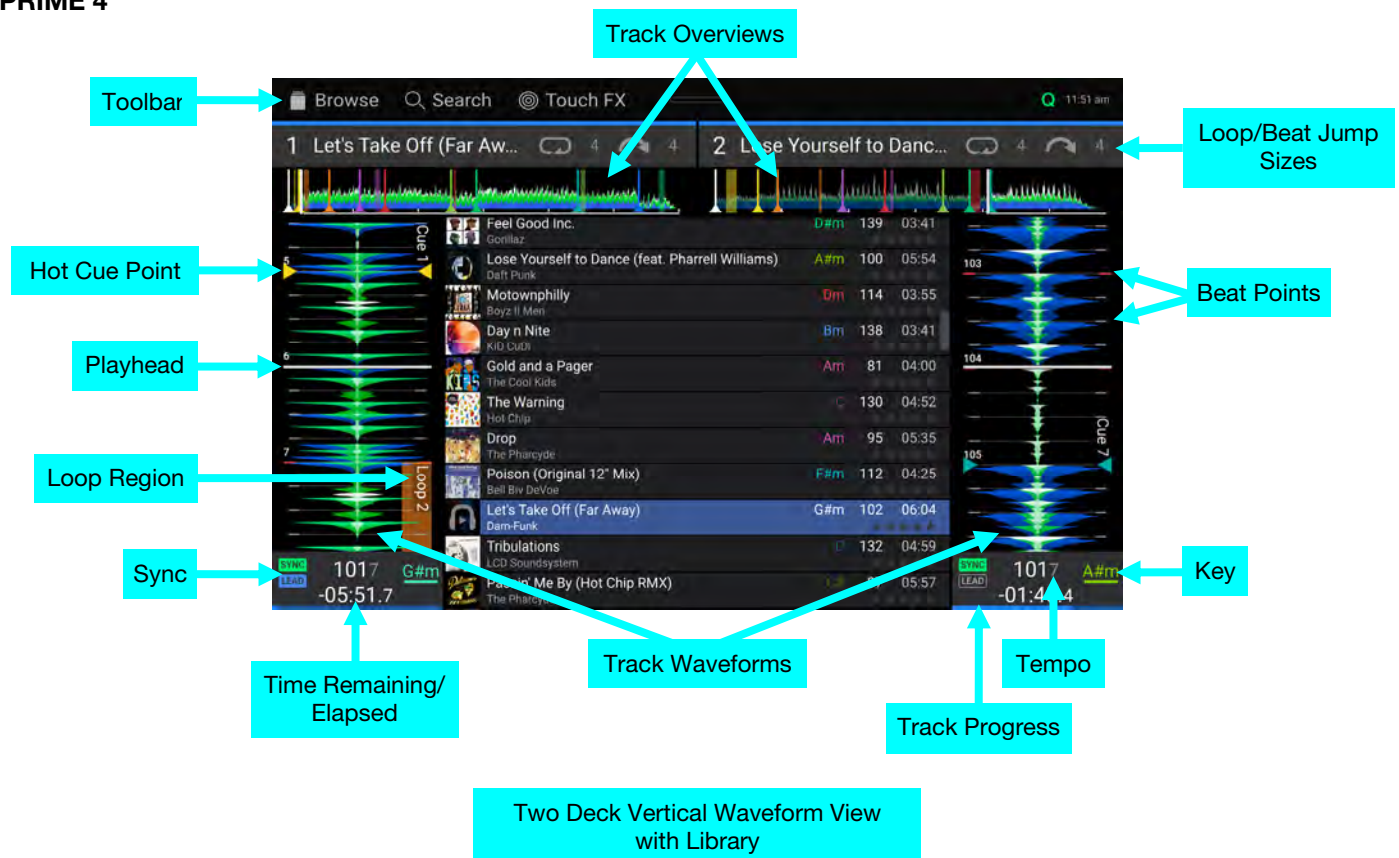

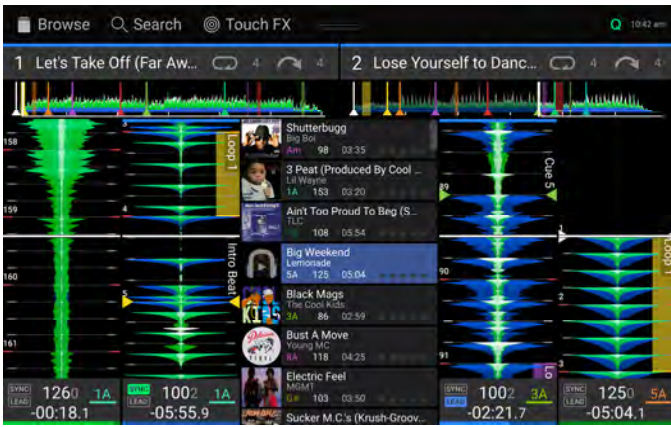

Four Deck Vertical Waveform View with Library

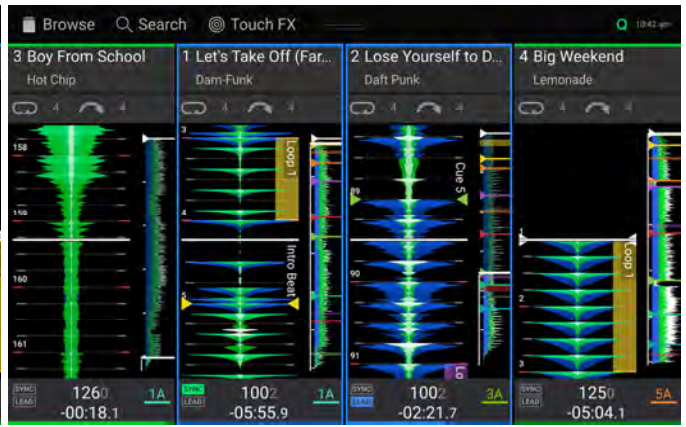

Four Deck Vertical Waveform View without Library

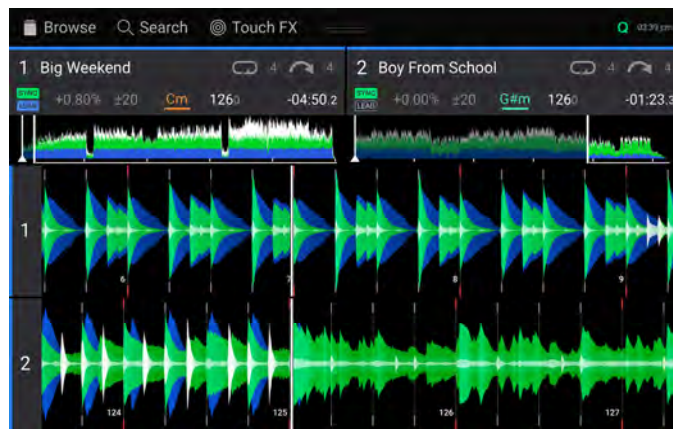

Two Deck Horizontal Waveform View

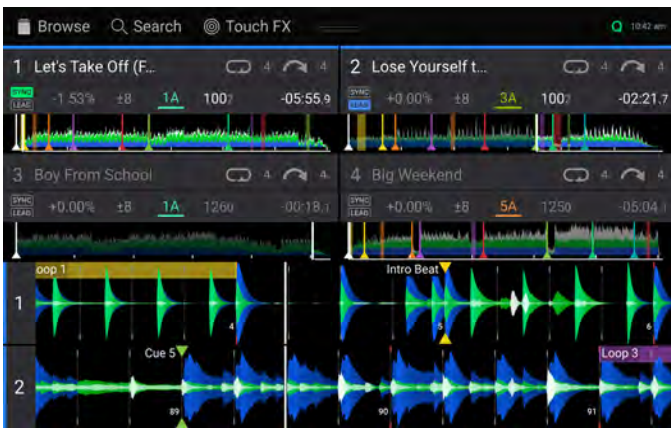

Four Deck Horizontal Waveform View With Two Visible Waveforms



Four Deck Horizontal Waveform View With Four Visible Waveforms

PRIME 2



Horizontal Waveform View

PRIME GO

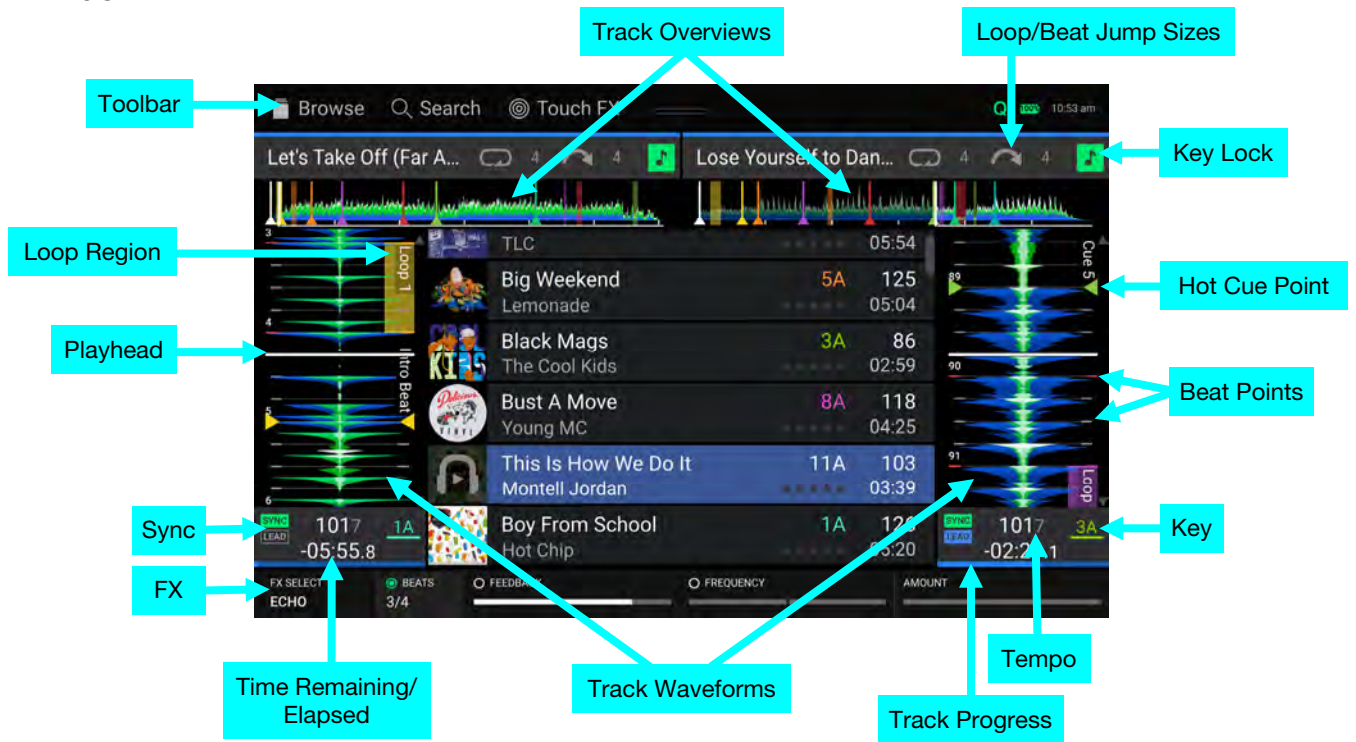

Horizontal Waveform View

SC LIVE 4 / SC LIVE 2

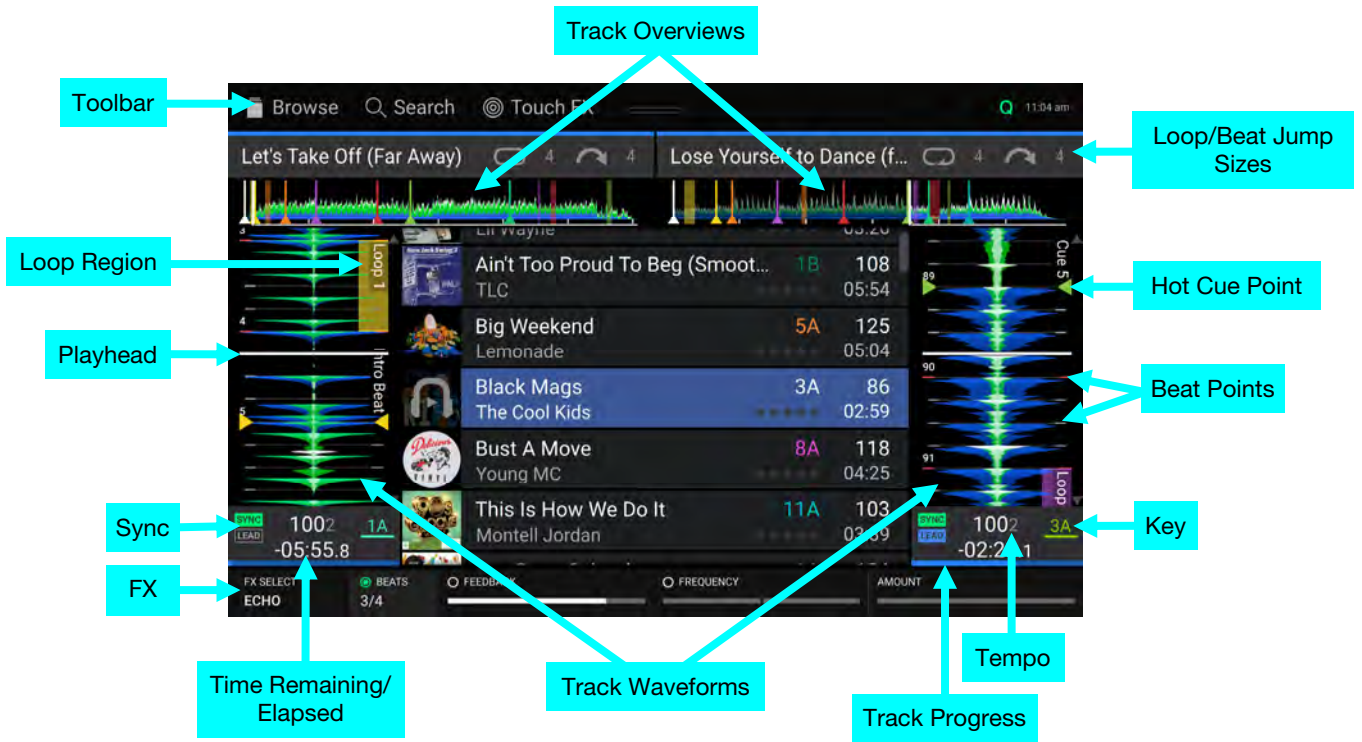

Two Deck Horizontal Waveform View

Four deck views only available with SC LIVE 4:



Four Deck Vertical Waveform View with Library

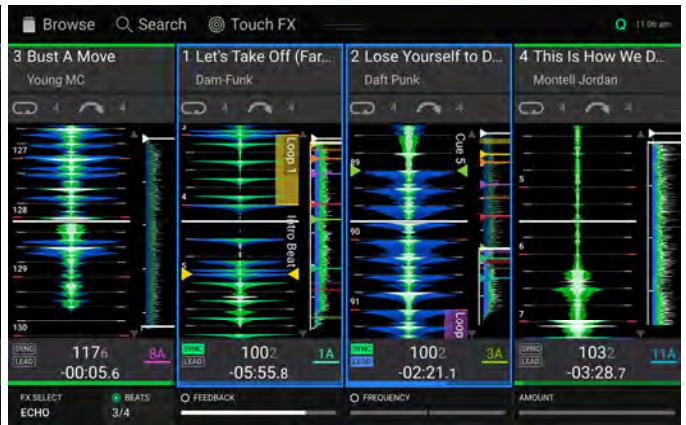

Four Deck Vertical Waveform View without Library



Four Deck Horizontal Waveform View With Two Visible Waveforms



Four Deck Horizontal Waveform View With Four Visible Waveforms

Central Library Preview

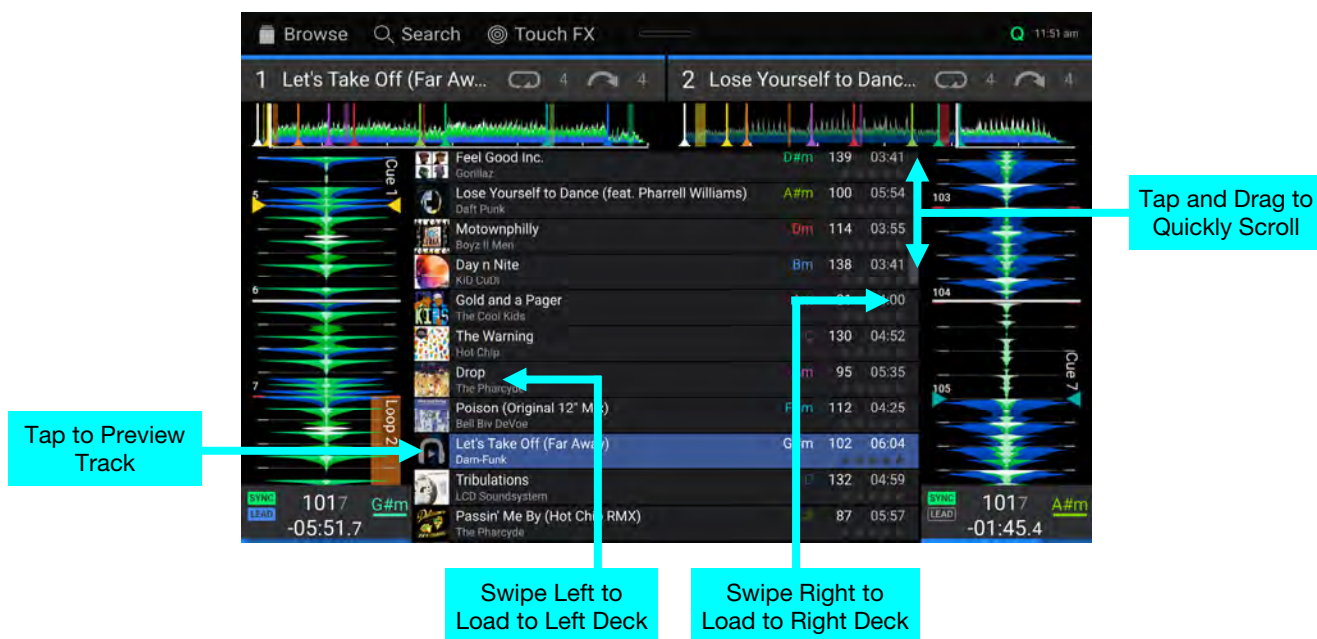

Swipe up or down to browse tracks.

Tap and drag the scroll bar to quickly browse through tracks.

Swipe right to load a track to the right active deck.

Swipe left to load a track to the left active deck.

Double-tap to load a track to a selected deck.

Tap the track art to preview the track. Tap again to stop previewing. While previewing, tap along the track entry to scan through the track.

Toolbar

The **toolbar** at the top of the touchscreen features shortcuts to [Library View](#) and displays the status of certain hardware and feature settings. **Swipe down** from this area to open the [Control Center](#).



Browse: Tap here to open the full [Library View](#) screen.

Search: Tap here to search for tracks using the keyboard that appears in the display.

Touch FX: Tap here to open the [Touch FX](#) screen.

Q: Tap here to enable or disable quantization. When enabled, time-based features like triggering cues and loops will snap to the beat-grid according to the **Cue/Loop Quantization** setting in your [User Profile](#).

Continue: The figure-eight icon indicates Continue is enabled, which will keep playing the next track when the active track has ended.

Wi-Fi: Shows the current Wi-Fi connection status.

Battery: Shows the current battery life (PRIME GO only).

Link: Shows the current Ableton Link status. Enabling Ableton Link will synchronize the beat, phase, and tempo of Ableton Live and your EngineOS hardware over a wireless or wired network.

Time: Displays the current local time. You can adjust the Time in the [Settings](#) menu.

Library View

Use the full Library View to view your music library and load a track to the deck. You can also search through playlists, add tracks to the Prepare list, and search through your tracks using sorting and filtering features.

Important: Visit enginedj.com/downloads to download the Engine DJ software.

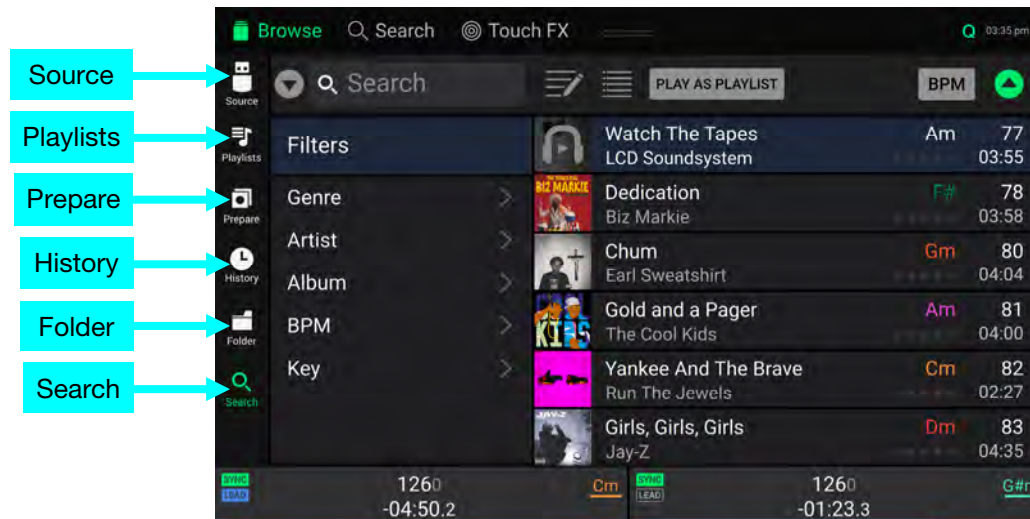

Use the six icons on the left side to navigate while in Library View:

- **Source:** Use this option to select the source device to view tracks from, including your connected media devices, available streaming and cloud services, Engine Remote Libraries, and pre-installed Demo and Sampler content. Tap the Source icon to show the list of available sources, and then tap to select. To enable streaming and cloud services, use the [Settings](#) menu.
- **Playlists:** Your playlists are your collections of tracks, including lists of tracks arranged in a specific order. You may have playlists for different types of clubs or events, for specific genres, etc. You can use the included Engine DJ software to create playlists to use here.
- **Prepare:** You can load tracks to the Prepare list so that you can refer to them later when you want to play them during your performance (rather than searching through your entire library for the next track to play).
- **History:** Use this option to view your playback history.
- **Folder:** Use this option to browse the list of all files on a USB drive or SD card.
- **Search:** Use this option to search through your tracks by keyword. See [Searching & Filtering Tracks](#) for more information.

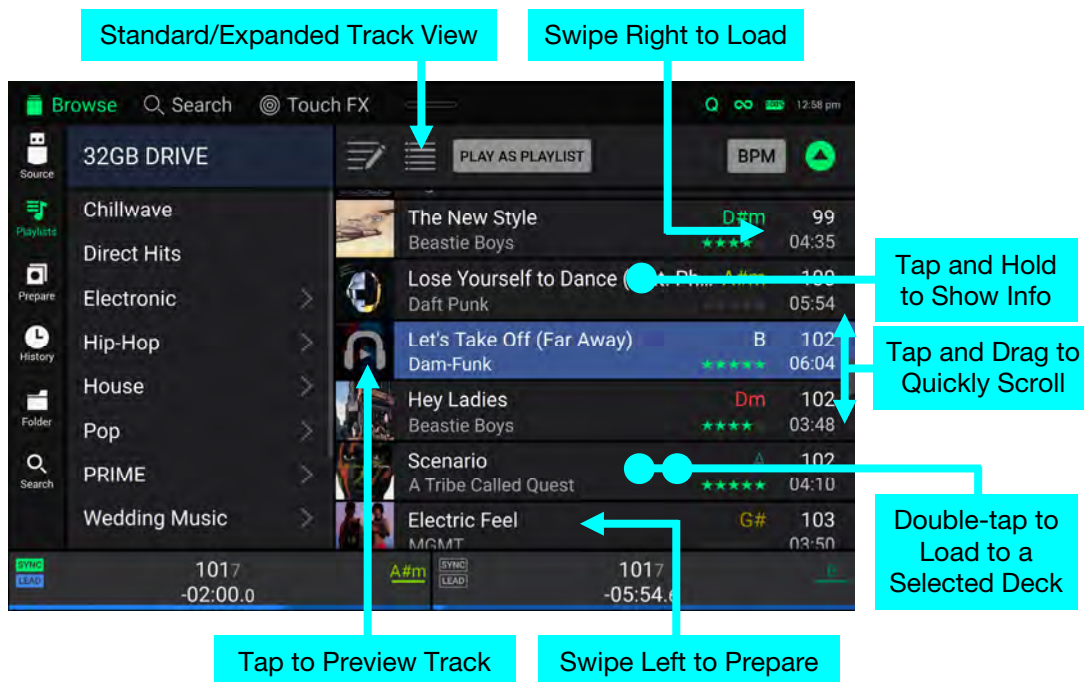

Tap the list icon at the top of the display to toggle between standard and expanded list views.

Swipe a list up or down to browse through it (e.g., your list of playlists or your list of tracks). Alternatively, press the **Back** or **Forward** buttons to select a list, and then turn the **Browse** knob.

Tap and drag the scroll bar to quickly browse through tracks.

Tap an icon or item in a list to select it (e.g., the icons for Playlists, Prepare List, Files, or Search on the left side of the Library). Alternatively, press the **Browse** knob.

Swipe a track to the right and tap **Load** to load it to a deck or sampler slot. Alternatively, press the **Browse** knob or double-tap the track. Tap the deck number, or turn and press the **Browse** knob, to select the desired deck.

Swipe a track to the left to add it to the Prepare list. Alternatively, press and hold **Shift** and press the **Browse** knob. Swipe a track to the left in the Prepare list to remove it.

Tap and hold your finger on a track to show its information window. Tap the information window to close it.

Tap the track art to preview the track. Tap again to stop the preview. While previewing, tap along the track entry to needle drop through the track.

Tap Play As Playlist to send the currently selected track list to a selected deck. See [Playlist Deck](#) to learn more.

Platter Display Overview

PRIME 4 and PRIME 2 feature built-in platter displays. Normally, these platter display shows the following information:

- the current position of the playhead.
- the album artwork of the current track, or your custom artwork.

The platter displays also temporarily show the following information:

- the current size of an auto loop after you turn the **Auto Loop** knob.
- the current beat jump size after you press **Shift** and one of the **Beat Jump** buttons to increase or decrease it.
- the current layer after you press the **Layer** button.
- the position of the secondary playhead when **Slip** is active.



Additionally, can add custom artwork to be shown on the display by doing the following:

1. Save a 600x600 pixel image as a **.PNG** file with the name “logo”.
2. Add this file to the **Engine Library** folder of an external storage drive with an Engine database.
3. The next time you use the drive with PRIME 4 or PRIME 2, the logo file will populate on the platter display.
4. To return to track artwork, simply delete the **logo.png** file from the Engine Library folder.

The SC LIVE 4 also contains a jog display which shows current track information. See [Jog Display](#) for more information.

Performing

Loading Tracks

To load a track to a deck, do any of the following:

- In the Central Library Preview, swipe the track to the left or right to load the track to the active deck on that side.
- In Library View, swipe the track to the right, and then tap Load. Next, tap the deck or sampler slot where you want the track loaded.
- Highlight the track using the **Browse** knob, and then press the **Load** ◀/▶ buttons to load the track to the active deck on that side.
- Highlight the track using the **Browse** knob, then press the encoder to bring up the deck selection screen. Turn the **Browse** knob to select the desired deck, and then press the knob to load the track to that deck.
- Double-tap the track to bring up the deck selection screen. Tap to select the desired deck.

To add a track to the Prepare list, swipe the track to the left while in **Library View**. Alternatively, press and hold **Shift** and press the **Browse** knob.

To show a track's information, tap and hold your finger on it.

While viewing the Prepare list:

Swipe left to remove the track from the Prepare list.

Tap the clear button in the upper-right corner of the display to remove all tracks from the Prepare list.



Searching & Filtering Tracks

To search, tap the **Search** field and use the keyboard that appears in the display. The search results can be based on the following criteria: title, artist, album, length, key, comment, BPM, genre, label, year, date added or filename. By default, only **Title** and **Artist** are selected. Use the dropdown menu next to the search bar to select other categories, or to **Search All** categories.

Note: To reduce search time, only select fields in which you wish to search.

To hide the keyboard, tap the **keyboard icon** in the lower-right corner of the virtual keyboard. Alternatively, tap anywhere on the screen other than the keyboard or the Search field.

To filter your tracks, tap **Genre**, **Artist**, **Album**, **BPM** or **Key**, and then tap one of the available options. Only tracks tagged with that genre, album, artist, BPM, or key will be shown. (By default, the key is notated using the Camelot system.) You can also use the **Search** field while tracks are filtered to refine your results.

Note: You can also use the User Profile to set whether you want to show tracks with the same key only or tracks with compatible keys as well as the “tolerance” of BPM filter (to include tracks with tempos within 1–15 BPM of the selection). See [User Profile](#) to learn more.

To sort the list of results, tap the **Sort By** icon in the upper-right corner, and then tap one of the available options. Tap the **arrow** icon next to this to toggle between ascending and descending order.

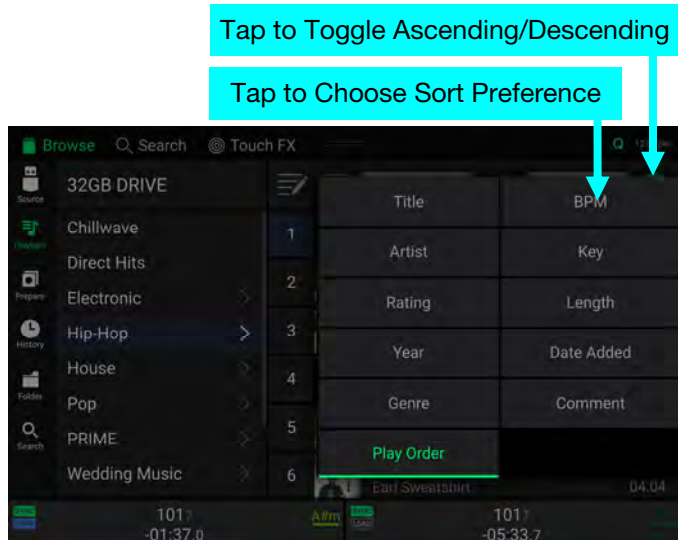
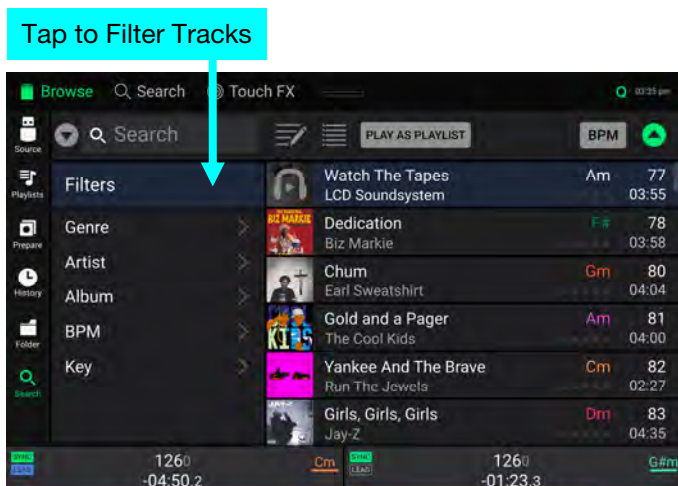
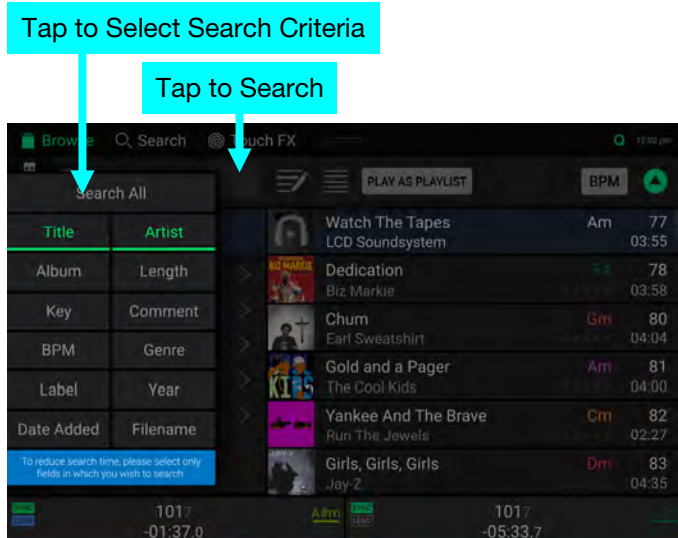

Editing Playlists

Tap the **edit button** at the top of the display while viewing the playlist screen. While editing is active, you can do any of the following:

To make a new playlist, tap **Create Playlist** in Playlist view.

To add tracks to your playlist, tap a track to select it, and the open circle will become filled. After selecting tracks, tap and hold to move the tracks. You can drag the tracks over a playlist or folder and release your finger to instantly add them.

To reorder tracks in a playlist, tap and hold on the track name (while editing mode is still active), then move your finger up or down to change the track order. You can also reorder playlists in the same way.

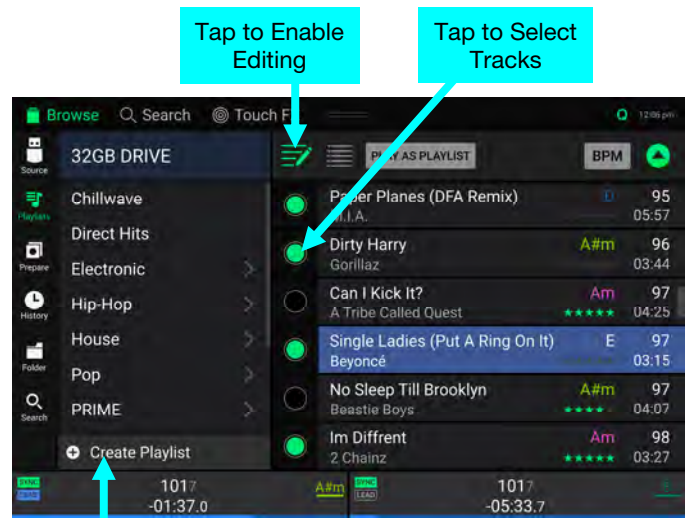

Tap to Create New Playlist

Tap, Hold & Drag to Move Tracks

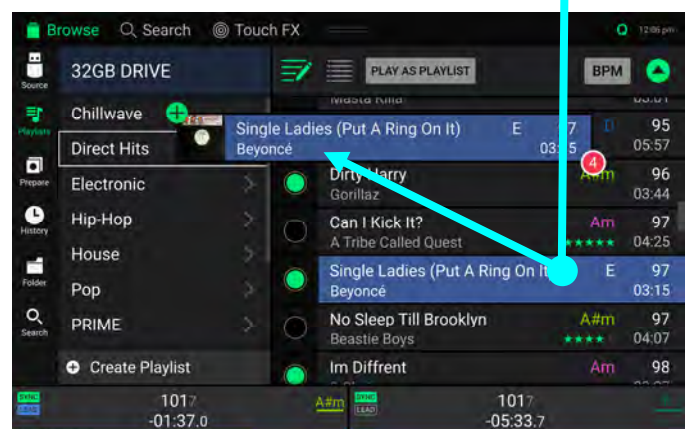

Playlist Deck

While in Library View, you can send the currently viewed file list to its own deck to play as a playlist.

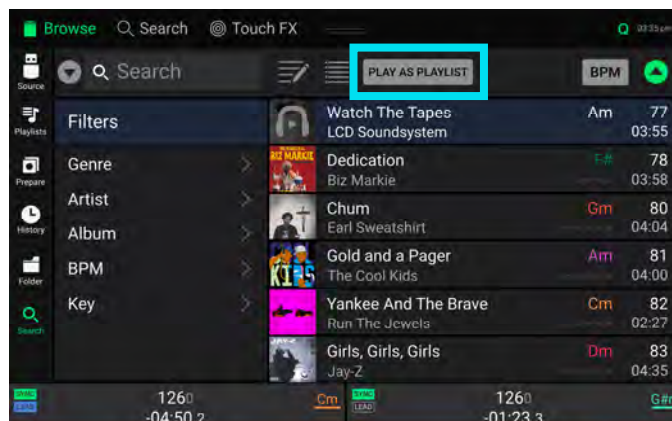

To enable Playlist Deck, tap **Play As Playlist** in Library view. When enabled, the playlist on deck will play through the selected track list and automatically crossfade between each track according to the **Playlist Deck Crossfade Time** parameter in the **Settings** menu.

When using PRIME 4, the playlist deck will always be on Deck 4, and enabling the **Zone Out** while active will isolate the Playlist Deck to these outputs. If you have an LC6000 PRIME unit connected to PRIME 4's **Rear USB Port 4**, this unit will be used to control the playlist deck. When using PRIME 2, PRIME GO, SC LIVE 4, or SC LIVE 2, you can select which deck is used for the playlist.

Note: In Performance view, playlist decks are only available in vertical view.

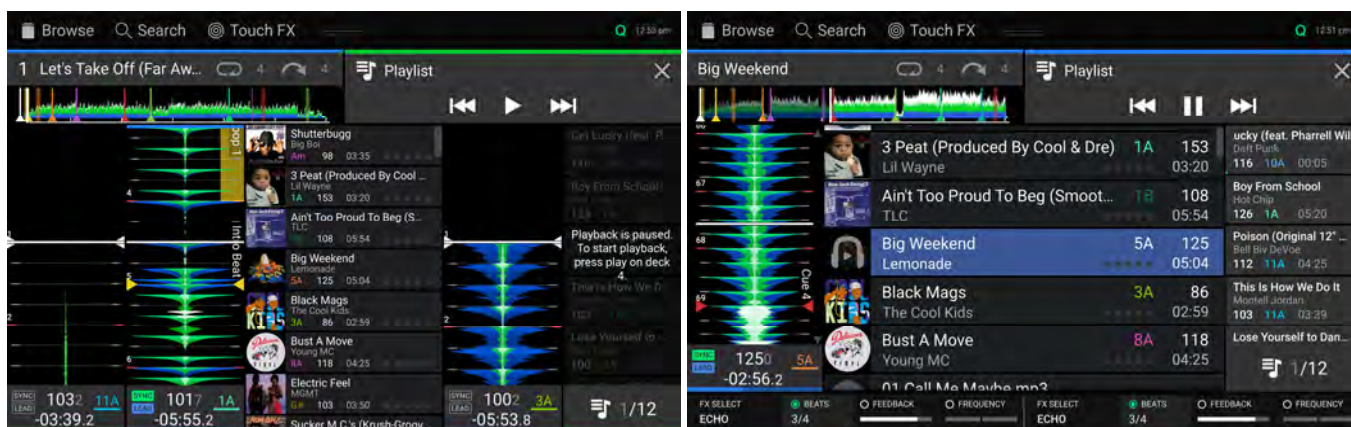

To enable playlist deck playback, press **Play** on the selected deck.

To change tracks within the playlist, use the **track backward** and **track forward** buttons in the track overview area, or using the **Track Skip** buttons on the hardware.

To remove the playlist from the deck, tap the **X** in the track overview area.

Playback & Cueing

To play or pause a track, press **Play/Pause** (▶/||).

To scratch a track, move the **platter** when the **Vinyl** button is set to **On** and audio is playing.

To set the cue point, press and hold **Shift** and press **Cue** at the desired location during playback.

To return to the cue point and stop, press **Cue**.

To return to the cue point and keep playing, press and hold **Shift** and press **Play/Pause** (▶/||).

To jump to a specific location in the track:

- If Needle Lock is **disabled**: tap the desired location in the track overview.
- If Needle Lock is **enabled**: pause playback and then tap the desired location in the track overview. Alternatively, make sure the **motor** is **on**, then stop the platter with your hand or palm to swipe through the track overview.

See [User Profile](#) to learn about Needle Lock.

To scan quickly through the track, press and hold **Shift** and press the **Track Skip** buttons (PRIME 4, PRIME 2, SC LIVE 4, SC LIVE 2) or press and hold **Shift** and rotate the **platter** (PRIME GO). Alternatively, drag your finger left or right through the waveform overview on the display.

To zoom in and out of the waveform, place two fingers on the display and spread them apart or pinch them together.

The functions below are only available on PRIME 4, PRIME 2, SC LIVE 4, and SC LIVE 2:

To censor playback, press and hold **Censor**.

To return to normal playback, release **Censor**. Normal playback will resume from where it would have been if you had never engaged the Censor feature (i.e., as if the track had been playing forward the whole time).

To reverse playback, press and hold **Shift** and press **Censor/Reverse**. The button will flash while playback is reversed.

To return to normal playback, press **Censor/Reverse**.

To skip to the previous or next track, press one of the **Track Skip** ◀/▶ buttons.

To return to the beginning of a track, press **Track Skip** ◀ in the middle of a track.

To jump back or forward, press the **Beat Jump** buttons.

To enable or disable Slip Mode, press **Slip**. In Slip Mode, you can jump to cue points, use the platters, or pause the track while the track's timeline continues (the lower half of the waveform in the main display will continue moving forward). When you stop whatever action you are performing, the track will resume normal playback from where it would have been if you had never done anything (i.e., as if the track had been playing forward the whole time).

Looping & Beat-Jumping

To create and activate an auto loop, press the **Auto Loop** knob.

To set the auto loop length, turn the **Auto Loop** knob to select the number of beats: **1/32, 1/16, 1/8, 1/4, 1/2, 1, 2, 4, 8, 16, 32, or 64.**

Note: You can set the default Auto Loop size in the **User Profile** menu. When a track is loaded, the Auto Loop size will be automatically reset to your preference.

To deactivate a loop, press the **Auto Loop** knob. Alternatively, press the **Manual Loop Out** button.

To move the loop, press and hold **Shift** and turn the **Auto Loop** knob. For PRIME GO, this can only be done while the loop is enabled.

To double or halve the length of a loop, turn the **Auto Loop** knob while the loop is enabled.

To beat-jump through a track, press one of the **Beat Jump** buttons (PRIME 4, PRIME 2, SC LIVE 4, and SC LIVE 2), or press and hold **Shift** and turn the **Auto Loop** knob when there is no enabled loop (PRIME GO). Each press or turn will skip through the track by the set length. You can adjust the beat jump length by pressing and holding **Shift** and pressing either **Beat Jump** button (PRIME 4, PRIME 2, SC LIVE 4, and SC LIVE 2), or by using the **Default Beat Jump Size** setting in the **User Profile** menu.

The functions below are only available on PRIME 4, PRIME 2, SC LIVE 4, and SC LIVE 2:

To create and activate a manual loop, press the **Manual Loop In** button to set the start point, and then press **Manual Loop Out** button to set the end point. The loop will be activated immediately, and the loop will be indicated as a shaded area in the waveform and track overview.

To manually edit the beginning or end of a loop, press **Loop In** or **Loop Out**, respectively, and then move the platter left or right to shorten or extend the loop region. Commit the edit by pressing **Loop In** or **Loop Out** again.

Syncing & Pitch Adjustment

To activate sync, press **Sync** on the deck that you want to control the BPM, which becomes the “sync lead.” After Sync is activated on that deck, press **Sync** on any additional decks. The tempo of each deck will immediately synchronize to match the tempo of the sync lead deck.

The Sync state icon in the display will indicate the current status:

 **Sync Off**

 **Sync On**

The Sync behavior is determined by the **Sync Mode** setting in the **User Profile** menu.

The Sync Lead icon in the display will indicate the current sync lead status:

 **Sync Lead**

 **Sync Follow**

To deactivate sync on a deck, press **Sync** again, or press and hold **Shift** and press **Sync**, depending on the setting of **Sync Button Action** in the **User Profile** menu.

To adjust the track's pitch, move the **pitch fader**. You can do this only when the deck is not synced.

To adjust the track's pitch momentarily, press and hold one of the **Pitch Bend -/+** buttons.

To adjust the range of the pitch fader, press and hold **Shift** and press one of the **Pitch Bend -/+** buttons to select **±4%, 8%, 10%, 20%, 50%, or 100%.**

To lock or unlock the track's key, press **Key Lock**. When Key Lock is activated, the track's key will remain the same even if you adjust its speed.

To reset the track's key, press and hold **Shift** and press **Key Lock**.

To activate key sync (the track's key will sync to the key of the track on the other active deck):

PRIME 4/PRIME 2/SC LIVE 4/SC LIVE 2: Press and hold **Key Lock/Key Sync** on the deck you would like to sync.

PRIME GO: Press and hold **Sync** on the deck you would like to sync.

Note: In order to activate Key Sync, playback must be enabled on at least 2 decks.

Beat Grid Editing

You can edit a track's beat grid directly from your EngineOS hardware, in the same way you can when using the Engine DJ software.

To enable beat grid editing, open the **Control Center** and tap the **Beat Grid Edit** icon. You can also open this menu directly by using the following hardware controls:

PRIME 4: Press and hold the **Edit Grid** button.

PRIME 2/SC LIVE 2/SC LIVE 4: Press and hold the **Slip/Edit Grid** button.

PRIME GO: Press and hold the **Vinyl** button.

Note: Beat grid editing is not accessible if there are no tracks added to the decks.

Important: When the **Cue/Loop Quantization** feature is **on**, hot cue points and loop points will be automatically aligned according to the degree of quantization. See [User Profile](#) to learn about this.



To adjust the position of the beats:

- Tap the **Downbeat Left/Right** buttons to move the beats based on the current analyzed grid.
- Tap the **Shift Left/Right** buttons or nudge the hardware platter to "slip" the entire grid left or right.
- Tap the **Insert Anchor** button to move the closest beat to the position of the playhead. All other beats will also shift accordingly. This allows you to create flexible beat grids for tracks with fluctuating tempo.
- Tap the **Delete Anchor** button to delete the closest anchor within a few beats.

To adjust the tempo:

- Tap the **BPM** field to input a new tempo. Use the number pad that appears to input the new value, and then tap the **Enter** button to accept it. Tap the **X** icon to cancel changes and return to the grid edit controls.
- Tap in the **Tap Tempo** icon area to manually set a tempo based on repeated taps.
- Tap the **Decrease/Increase BPM** buttons to decrease and increase BPM in small increments.
- Tap the **2X** and **/2** buttons to double or halve the current BPM.

To reset the beats to the original analyzed tempo and grid, tap the **Reset** button.

To lock the beat grid, tap the **lock** icon. When locked, further editing is prevented and all other Grid Edit controls will be greyed out.

To exit beat grid editing, tap the **X** in the top-right corner of the touchscreen, or select another mode.

Pad Modes

The eight performance pads on each deck have different functions in each pad mode.

To enter each pad mode, press the corresponding button:

- **PRIME 4 / PRIME 2 / SC LIVE 4: Hot Cue, Loop, Roll, or Slicer.**
- **PRIME GO / SC LIVE 2: Hot Cue, Loop, or Roll.**

To enter **Sampler Mode**, press the **Roll** button twice.

Hot Cue Mode

In Hot Cue Mode, you can use each pad to jump to an assigned hot cue point.

Tip: You can use the Engine DJ software to set, name, and assign colors to your hot cue points. The names and colors will appear in the display for reference.

To **assign a hot cue to a pad**, press an unlit pad at the desired location in the track. The pad will light up when a hot cue point is assigned.

To **jump to a hot cue point**, press the corresponding pad.

To **clear a hot cue from a pad**, press **Shift** and the desired pad. The pad will turn off when there is no hot cue point assigned to it.

Loop Modes

In Manual Loop Mode, you can use each pad to enable an assigned loop. Pressing Loop for the first time will always enter Manual Loop Mode.

Tip: You can use the Engine DJ software to set and name your loops. The names will appear in the display for reference.

To **assign a loop to a pad and enable it**, press an unlit pad to create a Loop In point at the current location, and then press it again to create the Loop Out point at another location. You can also assign an auto loop to a pad by pressing an unlit pad while in the auto loop. The loop will activate immediately, and the pad will light up.

To **enable a loop**, press the corresponding pad. Once a loop has been created, you can also retrigger it by pressing the corresponding pad again, depending on the **Saved Loop Behavior** setting in the [User Profile](#).

To **enable an active loop**, press and hold the **Parameter** ◀ button and press a pad with a saved loop. Active loops will begin looping automatically as soon as they are reached, and are shown with a striped pattern in the track waveform. You can also set these in the Engine DJ software.

To **delete a loop**, press **Shift** and the desired pad.

In Auto Loop Mode, you can use each pad to create and activate an auto loop. Pressing Loop while in Manual Loop Mode will enter Auto Loop Mode.

To **activate an auto loop**, press a pad. The display will show the length of the auto loop for each pad.

To **deactivate an auto loop**, press the pad again.

To **increase or decrease the length of the auto loop**, use the **parameter buttons** (◀/▶).

To **shift the loop region forward or backward**, press and hold **Shift** and use the **parameter buttons** while a loop is engaged.

Roll Mode

In Roll Mode, you can press and hold each pad to trigger a “loop roll” of a certain length while the track’s timeline continues (the lower half of the waveform in the display will continue moving forward). When you release the pad, the track will resume normal playback from where it would have been if you had never done anything (i.e., as if the track had been playing forward the whole time).



(T denotes a triplet-based time division)

To trigger a roll, press the corresponding pad. Pads with triplet-based loop rolls are indicated are lit with a different color.

Slicer Modes

In Slicer Mode (PRIME 4, PRIME 2, or SC LIVE 4 only), the eight pads represent eight sequential beats—“slices”—in the beatgrid. When you press **Slicer**, you automatically activate an eight-beat loop. The currently playing slice is represented by the currently lit pad; the light will “move through the pads” as it progresses through the eight-slice phrase. You can press a pad to play that slice. When you release the pad, the track will resume normal playback from where it would have been if you had never pressed it (i.e., as if the track had been playing forward the whole time).

To play a slice, press the corresponding pad.

In Slicer Loop Mode (second press), the eight pads represent eight sequential beats—“slices”—in the beatgrid. The currently playing slice is represented by the currently lit pad; the light will “move through the pads” as it progresses through the eight-slice phrase, which will loop (this is the difference between this mode and Slicer Mode). You can press a pad to play that slice. When you release the pad, the track will resume normal playback from where it would have been in the loop if you had never pressed it (i.e., as if the track had been playing forward the whole time).

Use the **parameter buttons** (◀/▶) while a slice is engaged to increase or decrease the length of the slice.

Sampler Mode

In addition to the Pad Modes above, EngineOS hardware also includes a Sampler Mode. This can be accessed from your hardware by pressing the **Roll** button twice.

In Sampler Mode, you can assign and trigger up to eight samples using your performance pads. For PRIME GO, press **Bank** to access the second bank of sampler slots. For SC LIVE 2, press and hold **Shift** and press **Roll** again to access the second bank of sampler slots.

You can view your assigned samples in Performance View by enabling the Performance Pads widget in the **Control Center**. When the Sampler pad mode is selected, you will see the sample names loaded to each pad in the slots below the track overview waveform.

Your hardware includes a set of pre-installed sample content, which you can browse from **Library View** when **Sampler Content** is selected as a source. You can enable or disable this content from appearing using the **Sampler Content** setting under **User Profile**.

To load a sample from Library View, swipe the sample to the right, or double-tap the sample. Next, instead of selecting a deck, tap one of the eight sampler slots on the touchscreen. Alternatively, press the hardware pad where you want the sample assigned. If a sample is already loaded to the selected pad, the new sample will replace the existing sample.

Loaded samples will be retained in memory across device reboots and changes in Source drive selection.

To trigger a sample, press the performance pad on the hardware.

The sampler volume can be adjusted using the **Sampler Volume** slider in the **Control Center**.

Sampler audio routing can be adjusted using the **Sampler Output** option in the **Settings** menu.

To stop a playing sample, hold **Shift** and press the performance pad.

To remove a sample, you must first exit Performance View. Samples cannot be removed while in Performance View to prevent accidental ejection. While in Library View, Settings, or another page, press and hold **Shift** and then press the performance pad with the sample you want to remove. If the sample is playing, you will need to stop it first, and then remove it.

Touch FX

The Touch FX feature allows you to control ten powerful audio effects via the touchscreen to create buildups, drops, and transitions with a single touch.

To access Touch FX, tap the **Touch FX** icon in the toolbar at the top of the screen.

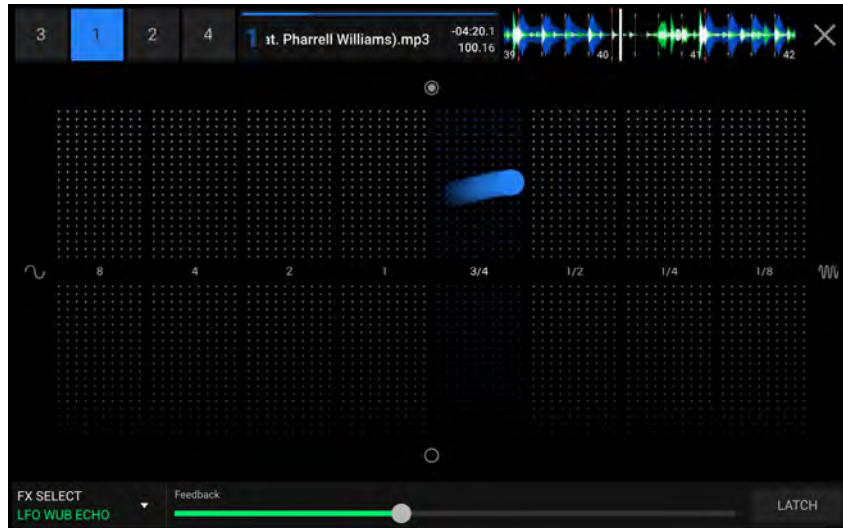

Touch FX can be applied to a single deck at a time. Tap the deck number in the upper-left corner of the screen to select the desired deck. The track name, time, BPM, and waveform overview will be shown.

Each effect has a pair of parameters, one mapped up and down and one mapped left and right, that can be continuously adjusted by tapping and dragging your finger around the center area.

To change the current effect, use the **FX Select** menu in the bottom-left corner of the screen to select from the following options:

- LFO Echo
- Filter Roll
- Filter Echo
- Filter Dub Echo
- Filter Gate
- Noise Gate
- Filter Reverb
- Flanger
- LFO Filter
- Filter

To adjust an additional effect parameter, such as a **Feedback** or **Resonance** control, use the slider at the bottom of the screen.

To hold the current position of the Touch FX, tap the **Latch** button at the bottom-right of the screen. The effect will remain on in any position you move it to until Latch is turned off. Latch will automatically turn off if you switch active decks or change FX selection while it is enabled.

To close Touch FX and return to the previous screen, tap the **X** icon in the upper-right corner of the screen. Alternatively, press **View**, **Back**, or **FWD** to switch to another screen.

Control Center

Press and hold the **View** button or swipe down from the toolbar to open the Control Center. Here, you can quickly adjust commonly used **Parameters** using the widgets in the center of the screen. You can also access the following pages. Click the links below to jump to that part of the guide:

- **User Profile** – This screen is used to edit your performance preferences.
- **Settings** – This screen is used to edit the settings of the EngineOS hardware.
- **Source** – This screen is used for selecting your source media device.
- **Wi-Fi** – This screen is used for connecting to and configuring your Wi-Fi network.
- **Record** – This screen is used for recording and saving your performances.
- **Engine Lighting** – This screen is used for working with the SoundSwitch Engine Lighting integration.

Parameters

PRIME 4 / PRIME 4+

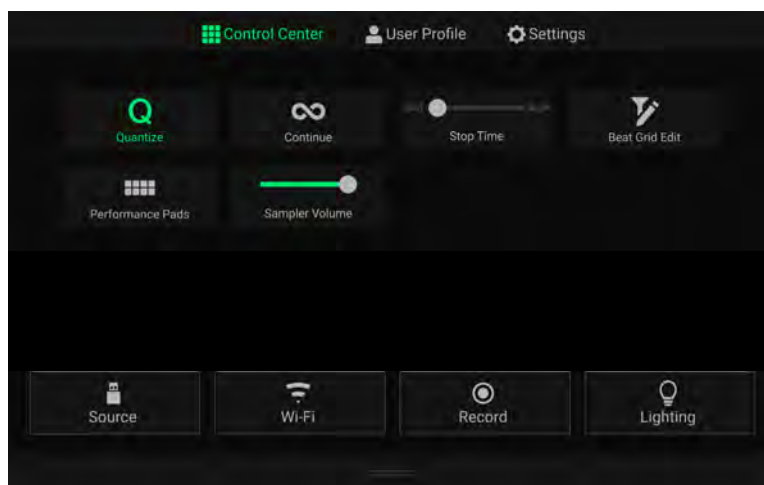

Quantize: Tap this to enable or disable quantization. When enabled, time-based features like triggering cues and loops will snap to the beat grid according to the **Cue/Loop Quantization** setting in your **User Profile**.

Continue: Tap this to enable or disable continuous playback, which will keep playing the next track when the active track has ended.

Stop Time: Use this slider to adjust the stop time, or how long the track takes to stop playing after the pause button is pressed.

Beat Grid Edit: Tap this to access beat grid editing from the touchscreen. See **Beat Grid Editing** for more information.

Performance Pads: Tap this to enable or disable the performance pads from appearing in Performance View. When enabled, the pads will be shown under the track overview on the touchscreen:

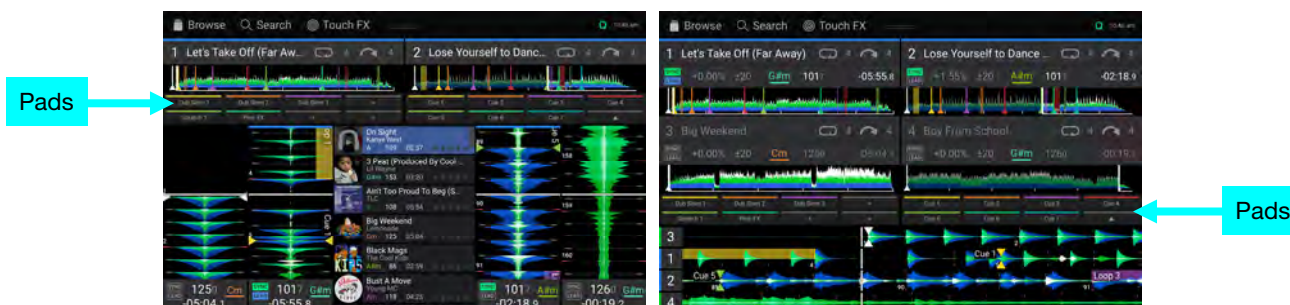

Sampler Volume: Use this slider to adjust the sampler volume level. See **Sampler Mode** for more information.

PRIME 2

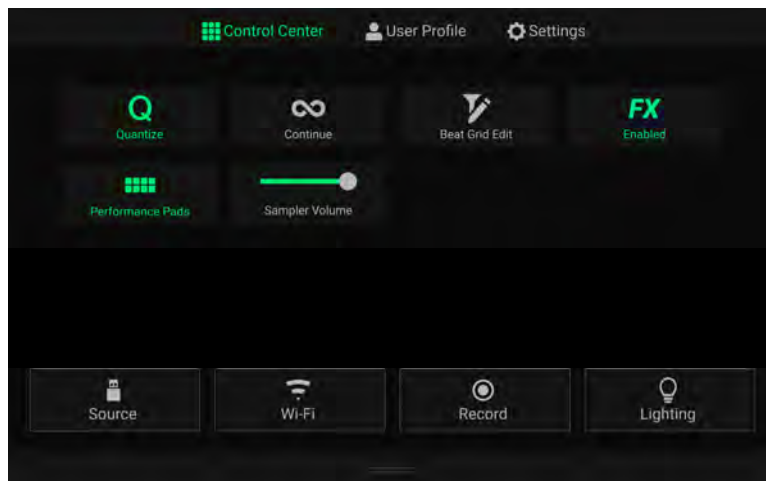

Quantize: Tap this to enable or disable quantization. When enabled, time-based features like triggering cues and loops will snap to the beat-grid according to the **Cue/Loop Quantization** setting in your **User Profile**.

Continue: Tap this to enable or disable continuous playback, which will keep playing the next track when the active track has ended.

Beat Grid Edit: Tap this to access beat grid editing from the touchscreen. See **Beat Grid Editing** for more information.

FX Enabled: Tap this to enable or disable **FX 1** and **FX 2**. When enabled, the FX selection and parameters will be shown at the bottom of the touchscreen (see below).

Performance Pads: Tap this to enable or disable the performance pads from appearing in Performance View. When enabled, the pads will be shown under the track overview on the touchscreen (see below).



Sampler Volume: Use this slider to adjust the sampler volume level. See **Sampler Mode** for more information.

PRIME GO

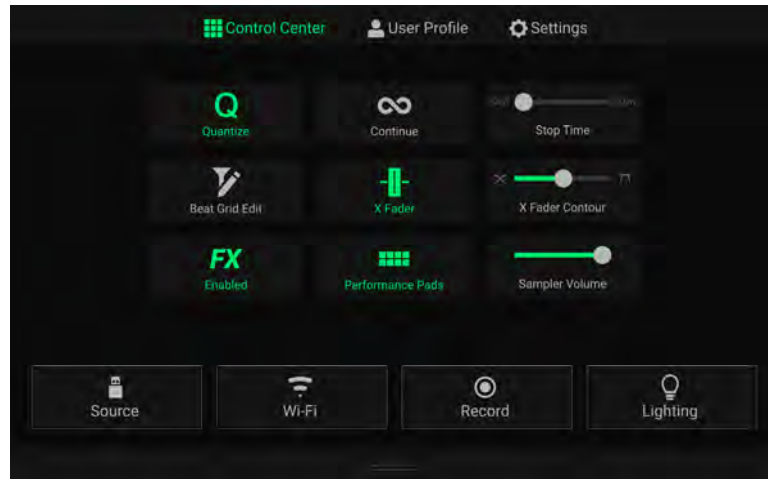

Quantize: Tap this to enable or disable quantization. When enabled, time-based features like triggering cues and loops will snap to the beat-grid according to the **Cue/Loop Quantization** setting in your [User Profile](#).

Continue: Tap this to enable or disable continuous playback, which will keep playing the next track when the active track has ended.

Stop Time: Use this slider to adjust the stop time, or how long the track takes to stop playing after the pause button is pressed.

Beat Grid Edit: Tap this to access beat grid editing from the touchscreen. See [Beat Grid Editing](#) for more information.

X Fader: Tap this to enable or disable the crossfader.

X Fader Contour: Use this slider to adjust the slope of the crossfader curve. Slide towards the left for a smooth fade (mixing) or slide to the right for a sharp cut (scratching). The center position is a typical setting for club performances.

FX Enabled: Tap this to enable or disable **FX 1** and **FX 2**. When enabled, the FX selection and parameters will be shown at the bottom of the touchscreen (see below).

Performance Pads: Tap this to enable or disable the performance pads from appearing in Performance View. When enabled, the pads will be shown under the track overview on the touchscreen (see below).



Sampler Volume: Use this slider to adjust the sampler volume level. See [Sampler Mode](#) for more information.

SC LIVE 4

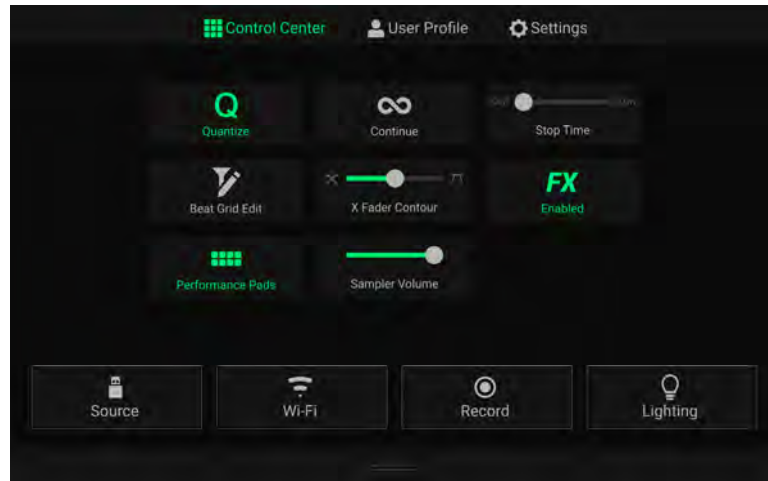

Quantize: Tap this to enable or disable quantization. When enabled, time-based features like triggering cues and loops will snap to the beat-grid according to the **Cue/Loop Quantization** setting in your [User Profile](#).

Continue: Tap this to enable or disable continuous playback, which will keep playing the next track when the active track has ended.

Stop Time: Use this slider to adjust the stop time, or how long the track takes to stop playing after the pause button is pressed.

Beat Grid Edit: Tap this to access beat grid editing from the touchscreen. See [Beat Grid Editing](#) for more information.

X Fader Contour: Use this slider to adjust the slope of the crossfader curve. Slide towards the left for a smooth fade (mixing) or slide to the right for a sharp cut (scratching). The center position is a typical setting for club performances.

FX Enabled: Tap this to enable or disable **FX 1** and **FX 2**. When enabled, the FX selection and parameters will be shown at the bottom of the touchscreen (see below).

Performance Pads: Tap this to enable or disable the performance pads from appearing in Performance View. When enabled, the pads will be shown under the track overview on the touchscreen (see below).

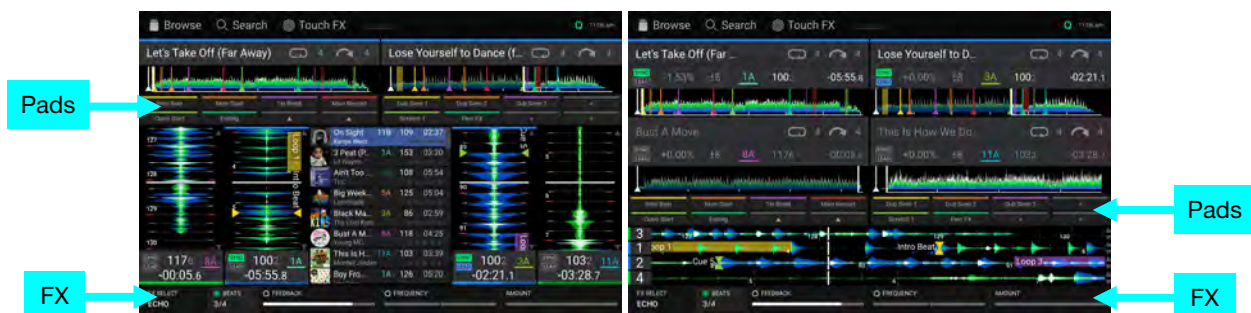

Sampler Volume: Use this slider to adjust the sampler volume level. See [Sampler Mode](#) for more information.

SC LIVE 2

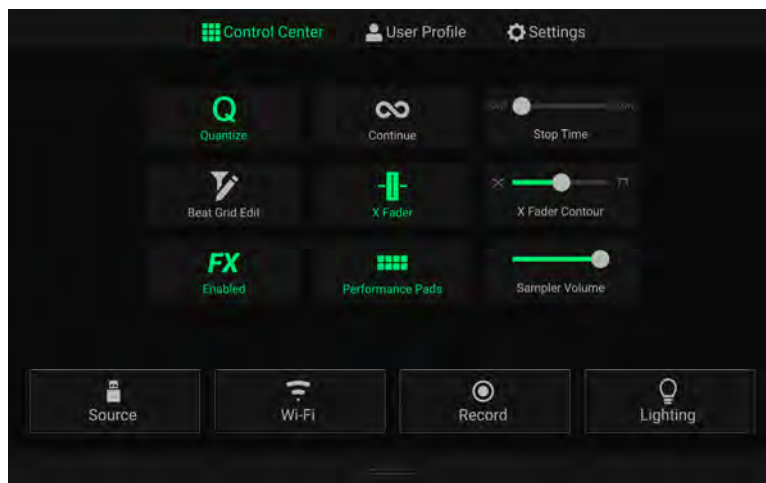

Quantize: Tap this to enable or disable quantization. When enabled, time-based features like triggering cues and loops will snap to the beat-grid according to the **Cue/Loop Quantization** setting in your [User Profile](#).

Continue: Tap this to enable or disable continuous playback, which will keep playing the next track when the active track has ended.

Stop Time: Use this slider to adjust the stop time, or how long the track takes to stop playing after the pause button is pressed.

Beat Grid Edit: Tap this to access beat grid editing from the touchscreen. See [Beat Grid Editing](#) for more information.

X Fader: Tap this to enable or disable the crossfader.

X Fader Contour: Use this slider to adjust the slope of the crossfader curve. Slide towards the left for a smooth fade (mixing) or slide to the right for a sharp cut (scratching). The center position is a typical setting for club performances.

FX Enabled: Tap this to enable or disable **FX 1** and **FX 2**. When enabled, the FX selection and parameters will be shown at the bottom of the touchscreen (see below).

Performance Pads: Tap this to enable or disable the performance pads from appearing in Performance View. When enabled, the pads will be shown under the track overview on the touchscreen (see below).

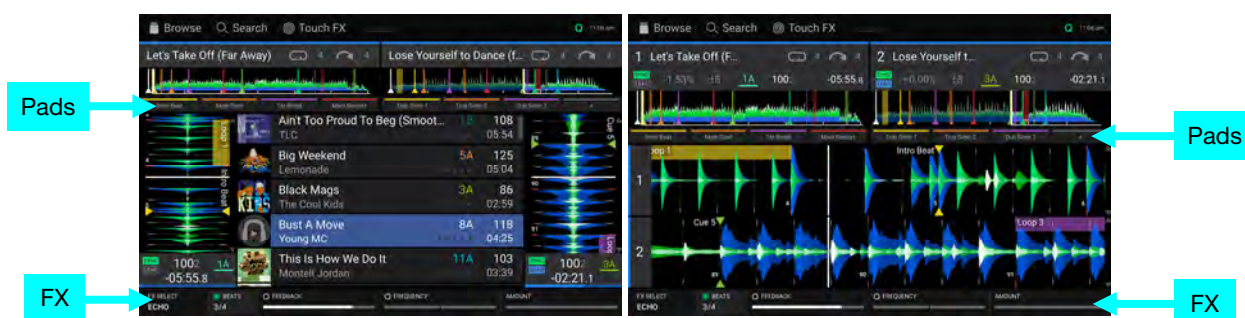

Sampler Volume: Use this slider to adjust the sampler volume level. See [Sampler Mode](#) for more information.

User Profile

Press the **Save To My Drive** button to save your settings to a connected drive. User profiles can be loaded when a media device with an Engine DJ profile is connected to your EngineOS hardware.

Playback

- **Track Start Position:** This setting determines where the beginning of a track is after it loads. Select the actual start of the file (**Track Start**) or the automatically detected beginning of an audio signal (**Cue Position**).
- **Default Speed Range:** This setting determines the range of the **pitch fader**. Select **±4%**, **8%**, **10%**, **20%** or **50%**.
- **Nudge Sensitivity:** This determines the level of sensitivity when moving the platters: **Min**, **Low**, **Mid**, **High**, or **Max**.
- **Sync Mode:** This setting determines the degree of synchronization applied when you press the Sync button on your EngineOS hardware:
 - **Bar:** The tempo will be synced, and the track will be automatically bar-matched with the track on the sync lead deck (the downbeats of each bar will be aligned).
 - **Beat:** The tempo will be synced, and the track will automatically beat-matched with the track on the sync lead deck.
 - **Tempo:** Only the tempo will be synced (the BPM will match that of the sync lead deck).
- **Sync Button Action:** This setting determines how the **Sync** button will act when pressed.
 - **Toggle:** This mode allows you to toggle sync on and off without having to hold **Shift**.
 - **Shift Disable:** This mode requires **Shift** to be held in order to turn off sync.
- **Always show Sync Lead Button:** This setting determines whether the **Sync Lead** button appears over the main waveforms in Performance View. You can tap this button to set the deck as the sync lead.
- **Pitch Control Type:** This setting determines the primary function of the Pitch Bend buttons. Select **Pitch Bend** to keep the primary function as momentarily reducing or increasing the pitch, or select **Range** to set the primary function to adjusting the range of the pitch fader. The function not used as the primary will still be available by holding **Shift** and using the **Pitch Bend** buttons.

Cues/Loops

- **Cue/Loop Quantization:** This setting determines the degree of quantization for time-based features. Select **1/8** beat, **1/4** beat, **1/2** beat, **1** beat or **4** beats.
- **Paused Hot Cue Behavior:** This setting determines how pads will play their hot cue points. When set to **Momentary**, playback will start from a hot cue point when you press and hold its pad—release the pad to return to the hot cue point. When set to **Trigger**, playback will start from a hot cue point (and continue) when you press and release its pad.
- **Default Loop Size:** This setting determines the default size of an auto loop when you load a new track to the deck: **None**, **1**, **2**, **4**, **8**, **16**, or **32** beats.
- **Default Beat Jump Size:** This setting determines the default size of the beat jump when you load a new track to the deck: **None**, **1**, **2**, **4**, **8**, **16**, or **32** beats.
- **Smart Loops:** This setting determines whether or not a manual loop will be automatically expanded or reduced to a conventional length (e.g., 2 beats, 4 beats, 8 beats, etc.) when you set it. Select **On** or **Off**. This setting works independently of the quantization setting.
- **Move Cue To Loop In:** This setting determines whether the song's **Cue Point** will automatically be moved to the start of a loop (**On**), or remain at its current point (**Off**).
- **Saved Loop Behavior:** This setting determines the action of loops after they have been saved. When set to **Reloop**, pressing a pad with a saved loop will start playing the loop again. When set to **Disable**, pressing a pad with a saved loop will turn off the loop.

Display

- **Track Title:** This setting determines whether tracks titles are shown as the track's **Filename** or its embedded **Metadata** (tags).
- **Time Format:** This setting determines whether or not pitch adjustment affects how the track time is displayed. When set to **Static**, the track's time corresponds to locations in the track as usual; adjusting the pitch does not affect it. When set to **Dynamic**, the track's time will automatically adjust to account for changes in pitch. For instance, if you set the pitch fader to **-8%**, the track time will increase so it is 8% longer.
- **Track End Warning:** This setting determines how long before the end of a track PRIME 4 will warn you that it is nearing the end. If the track is on the currently selected deck, the **platter** ring and **track overview** will flash. If the track is on the opposite deck, the **Deck** button will flash.
- **On Air Mode (PRIME 4 only):** This setting changes the platter ring illumination when the channel fader on the PRIME 4 mixer is up or down, indicating an active or "on air" deck. When this setting is **On**, raising the channel fader will change the platter color from **white** to the selected color. When this setting is **Off**, the user-selected color will always be shown regardless of the channel fader position.

Safety

- **Lock Playing Deck:** This setting determines whether or not you will be able to load a track to the deck as it is playing. Select **On** or **Off**. When this setting is on, the deck must be paused in order to load a track to it.
- **Needle Lock:** This setting determines whether or not you can tap the **track overview** in the display to jump to that location in the track during playback. Select **On** or **Off**. You can use the track overview while playback is stopped regardless of this setting.
- **Pad Lock:** This setting determines whether the pads and pad mode buttons are always enabled (**Off**) or disabled (**On**). When disabled, the pads and pad mode buttons will not be lit.

Library

- **Key Notation:** This setting determines how the track key is notated in the display. You can view the key as all **Sharps**, all **Flats**, **Open Key**, or **Camelot**.
- **Key Filter:** This setting determines whether the **Key** filter shows tracks with the same key only (**Match**) or tracks with compatible keys (**Compatible**).
- **BPM Range:** This setting determines the lowest- and highest-possible BPM values that will be used when tracks are analyzed: **58–115**, **68–135**, **78–155**, **88–175**, or **98–195 BPM**.
- **BPM Filter Tolerance:** This setting determines the "tolerance" of the **BPM** filter so you can include tracks with tempos that are within a small range of the selected tempo. Select **±0**, **1**, **2**, **3**, **5**, **10**, or **15**.
- **Collection Browse Behavior:** This setting determines browsing behavior when using the Library. When set to **Select**, tapping a playlist or folder will select it, and a double-tap is required to open it. When set to **Open**, tapping a playlist or folder will open it.
- **Demo Content:** Use this option to enable or disable the pre-installed demo content from appearing on your device.
- **Sampler Content:** Use this option to enable or disable the pre-installed sampler content.

Deck Colors

To change the deck ring color, tap the color box under the name of the deck, and then tap the color to select.

Settings

PRIME 4 / PRIME 4+

Device

- **Deck 3/4:** This determines whether this PRIME 4 will use both deck layers (**On**) or just one (**Off**).
- **Wi-Fi:** This determines whether Wi-Fi connectivity is enabled (**On**) or disabled (**Off**). Tap the **gear icon** to open the Wi-Fi settings. See [Wi-Fi](#) for more information about the Wi-Fi menu.
- **Time/Date:** This displays the current local time and date. Tap **Sync Time** when connected to the internet to automatically sync the time.
- **Time Zone:** Displays the current time zone, formatted as **Continent / City**.
- **Set time zone manually:** Enable this setting and then tap the **gear icon** to manually set your local time zone.
- **Platter Touch Sensitivity:** Tap **Calibrate** to recalibrate the touch sensitivity of the platters to default. Make sure not to touch the platters during calibration.
- **Track Preview:** When active, Track Preview will reveal a play button for each song in the library, allowing the songs to be auditioned in the cue without loading a song to the deck. Select **On** or **Off**.
- **Preview Volume:** Use this slider to set the volume level of the track preview (**0–100%**).
- **Screen Brightness:** This setting determines the brightness of the main display: **Low**, **Mid**, **High**, or **Max**.

Mixer

- **Sampler Output:** This setting determines where Sampler audio is routed: **Ch 3**, **Ch 1**, **Ch 2**, **Ch 4**, or **Main**.
- **Playlist Deck Crossfade Time:** Use this slider to adjust the amount of crossfade between tracks when using the playlist deck.
- **Master Limiter:** This setting determines the maximum output level of the master mix. Select **Off** to disable the limiter, or set the maximum output level from **18** to **0 dB**.
- **EQ Type:** This setting determines the type of equalization for the **Channel EQ** knobs. Select **Isolate** for EQ bands with infinite cut for full band "kills," or select **Norm** for EQ bands with limited cut.
- **ISO EQ High Xover:** When EQ Type is set to Isolate, this setting determines the crossover frequency between the Mid and High EQ bands, from **1000** to **8000 Hz**.
- **ISO EQ Low Xover:** When EQ Type is set to Isolate, this setting determines the crossover frequency between the Low and Mid EQ bands, from **100** to **800 Hz**.
- **Filter Resonance:** This setting determines the amount of resonance of the filter, from **0** to **15**.
- **Filter Extreme Type:** This setting determines the effect of the Sweep Filters at the extreme low and high ends. Select **Kill** for the filter extremes to end in silence, or select **Bleed** to allow the extreme end of the filter to play.
- **FX Noise Volume:** This setting determines the level of the Noise Sweep effect in the mix when active, from **-20** to **15 dB**.
- **Headphone Gain:** This setting determines the amount of gain for the **Headphones** outputs, from **-10** to **10 dB**.
- **Cue Solo Mode:** This setting determines how many channels can be sent to the cue mix. Set to **On** to have only one channel at a time in the cue mix, or set to **Off** to cue multiple channels at a time.
- **Split Cue Output:** This setting determines the stereo positioning of the pre-fader cueing mix and main mix when Split Cue is enabled. When set to **Normal**, the pre-fader cue mix will be stereo left and the main mix will be stereo right. When set to **Invert**, the pre-fader cue mix will be stereo right and the main mix will be stereo left.
- **Effect Select Behavior:** When set to **Default**, all effects settings will return to their default settings when a new track is loaded. When set to **Recall**, effects settings will be retained.
- **Reset Effects to Default Settings:** Tap here to manually reset effects to the default settings.

Mic

- **Talkover Level:** This setting determines the amount of reduction to the program audio level when talkover is active, from **-40** to **-20 dB**.
- **Talkover Resume:** This setting determines how quickly program audio returns to the set level when talkover is inactive, either **Normal** or **Fast**.
- **Mic 1 Attenuation:** This setting determines the amount of additional attenuation for the **Microphone 1 Input**, from **-15** to **0 dB**.
- **Mic 2 Attenuation:** This setting determines the amount of additional attenuation for the **Microphone 2 Input**, from **-15** to **0 dB**.
- **Mic 1 Threshold:** This setting determines the mic talkover gate threshold for the **Microphone 1 Input**, either **Off** or from **-79** to **-30 dB**.
- **Mic 2 Threshold:** This setting determines the mic talkover gate threshold for the **Microphone 2 Input**, either **Off** or from **-79** to **-30 dB**.
- **Send to Booth:** This setting determines whether the microphone signal is sent to the booth outputs (**On**) or not (**Off**).
- **Send to Headphones:** This setting determines whether the microphone signal is sent to the headphone output (**On**) or not (**Off**).
- **Send to Zone:** This setting determines whether the microphone signal is sent to the zone output (**On**) or not (**Off**).

Services

- **Lighting:** This determines whether SoundSwitch Engine Lighting is enabled (**On**) or disabled (**Off**). Tap the **gear icon** to open the lighting control interface.
- **Sync:** This determines whether Ableton Link is enabled (**On**) or disabled (**Off**). Ableton Link synchronizes beat, phase, and tempo of Ableton Live and Ableton Link-enabled applications over a wireless or wired network. You must be connected to the internet to use Ableton Link.
- **Streaming:** Use these options to enable or disable connections to streaming service partners. When set to **On**, the selected service will be available in the **Source** menu.
- **Cloud:** Use this option to retrieve your Engine library database from a cloud storage service. You must first use the Engine DJ software to back up your database. Then, when this option is set to **On**, the selected service will be available in the **Source** menu and you can access these files over an established internet connection.

Note: We recommend using only high-quality, name brand USB 3.0 or Class U1 or U3 SD cards as source drives, especially when cloud services are enabled.

About / Update

This page displays the product name, current firmware version, and other device information.

- **Update Firmware Version:** If you are not running the latest firmware, tap **Reboot** to restart PRIME 4 in Update Mode, which enables you to update its firmware. Follow the firmware update instructions included with the firmware update package you downloaded.
- **Send Anonymous Usage Statistics:** This determines whether or not your usage statistics will be sent occasionally to us, enabling us to improve the Engine experience.
- **Factory Reset:** Tap here to restore the default factory settings for your device.
- **Legal:** Tap here to view the Denon DJ EULA and patent list.

PRIME 2

Device

- **Wi-Fi:** This determines whether Wi-Fi connectivity is enabled (**On**) or disabled (**Off**). Tap the **gear icon** to open the Wi-Fi settings. See [Wi-Fi](#) for more information about the Wi-Fi menu.
- **Time/Date:** This displays the current local time and date. Tap **Sync Time** when connected to the internet to automatically sync the time.
- **Time Zone:** Displays the current time zone, formatted as **Continent / City**.
- **Set time zone manually:** Enable this setting and then tap the **gear icon** to manually set your local time zone.
- **Track Preview:** When active, Track Preview will reveal a play button for each song in the library, allowing the songs to be auditioned in the cue without loading a song to the deck. Select **On** or **Off**.
- **Preview Volume:** Use this slider to set the volume level of the track preview (**0–100%**).
- **Screen Brightness:** This setting determines the brightness of the main display: **Low**, **Mid**, **High**, or **Max**.

Mixer

- **Sampler Output:** This setting determines where Sampler audio is routed: **Ch 1**, **Ch 2**, or **Main**.
- **Playlist Deck Crossfade Time:** Use this slider to adjust the amount of crossfade between tracks when using the playlist deck.
- **EQ Type:** This setting determines the type of equalization for the **Channel EQ** knobs. Select **Isolate** for EQ bands with infinite cut for full band "kills," or select **Norm** for EQ bands with limited cut.
- **ISO EQ High Xover:** When EQ Type is set to Isolate, this setting determines the crossover frequency between the Mid and High EQ bands, from **1000** to **8000 Hz**.
- **ISO EQ Low Xover:** When EQ Type is set to Isolate, this setting determines the crossover frequency between the Low and Mid EQ bands, from **100** to **800 Hz**.
- **Filter Resonance:** This setting determines the amount of resonance of the filter, from **0** to **15**.
- **Filter Extreme Type:** This setting determines the effect of the Sweep Filters at the extreme low and high ends. Select **Kill** for the filter extremes to end in silence, or select **Bleed** to allow the extreme end of the filter to play.
- **FX Noise Volume:** This setting determines the level of the Noise Sweep effect in the mix when active, from **-20** to **15 dB**.
- **Cue Solo Mode:** This setting determines how many channels can be sent to the cue mix. Set to **On** to have only one channel at a time in the cue mix, or set to **Off** to cue multiple channels at a time.
- **Effect Select Behavior:** When set to **Default**, all effects settings will return to their default settings when a new track is loaded. When set to **Recall**, effects settings will be retained.
- **Reset Effects to Default Settings:** Tap here to manually reset effects to the default settings.

Mic

- **Attenuation:** This setting determines the amount of additional attenuation for the **Microphone Inputs**: **-20 dB**, **-10 dB** or **0 dB**.
- **Send to Booth:** This setting determines whether the microphone signal is sent to the booth outputs (**On**) or not (**Off**).

Services

- **Lighting:** This determines whether SoundSwitch Engine Lighting is enabled (**On**) or disabled (**Off**). Tap the **gear icon** to open the lighting control interface.
- **Sync:** This determines whether Ableton Link is enabled (**On**) or disabled (**Off**). Ableton Link synchronizes beat, phase, and tempo of Ableton Live and Ableton Link-enabled applications over a wireless or wired network. You must be connected to the internet to use Ableton Link.
- **Streaming:** Use these options to enable or disable connections to streaming service partners. When set to **On**, the selected service will be available in the **Source** menu.
- **Cloud:** Use this option to retrieve your Engine library database from a cloud storage service. You must first use the Engine DJ software to back up your database. Then, when this option is set to **On**, the selected service will be available in the **Source** menu and you can access these files over an established internet connection.

Note: We recommend using only high-quality, name brand USB 3.0 or Class U1 or U3 SD cards as source drives, especially when cloud services are enabled.

About / Update

This page displays the product name, current firmware version, and other device information.

- **Update Firmware Version:** If you are not running the latest firmware, tap **Reboot** to restart PRIME 2 in Update Mode, which enables you to update its firmware. Follow the firmware update instructions included with the firmware update package you downloaded.
- **Send Anonymous Usage Statistics:** This determines whether or not your usage statistics will be sent occasionally to us, enabling us to improve the Engine experience.
- **Factory Reset:** Tap here to restore the default factory settings for your device.
- **Legal:** Tap here to view the Denon DJ EULA and patent list.

PRIME GO

Device

- **Wi-Fi:** This determines whether Wi-Fi connectivity is enabled (**On**) or disabled (**Off**). Tap the **gear icon** to open the Wi-Fi settings. See [Wi-Fi](#) for more information about the Wi-Fi menu.
- **Time/Date:** This displays the current local time and date. Tap **Sync Time** when connected to the internet to automatically sync the time.
- **Time Zone:** Displays the current time zone, formatted as **Continent / City**.
- **Set time zone manually:** Enable this setting and then tap the **gear icon** to manually set your local time zone.
- **Track Preview:** When active, Track Preview will reveal a play button for each song in the library, allowing the songs to be auditioned in the cue without loading a song to the deck. Select **On** or **Off**.
- **Preview Volume:** Use this slider to set the volume level of the track preview (**0–100%**).
- **Screen (Plugged In):** This setting determines the brightness of the main display when the power cable is plugged in: **Low**, **Mid**, **High**, or **Max**.
- **Screen (Battery):** This setting determines the brightness of the main display when running on battery power: **Low**, **Mid**, **High**, or **Max**.

Mixer

- **Sampler Output:** This setting determines where Sampler audio is routed: **Ch 1**, **Ch 2**, or **Main**.
- **Playlist Deck Crossfade Time:** Use this slider to adjust the amount of crossfade between tracks when using the playlist deck.
- **EQ Type:** This setting determines the type of equalization for the **Channel EQ** knobs. Select **Isolate** for EQ bands with infinite cut for full band "kills," or select **Norm** for EQ bands with limited cut.
- **ISO EQ High Xover:** When EQ Type is set to Isolate, this setting determines the crossover frequency between the Mid and High EQ bands, from **1000** to **8000 Hz**.
- **ISO EQ Low Xover:** When EQ Type is set to Isolate, this setting determines the crossover frequency between the Low and Mid EQ bands, from **100** to **800 Hz**.
- **Filter Resonance:** This setting determines the amount of resonance of the filter, from **0** to **15**.
- **Filter Extreme Type:** This setting determines the effect of the Sweep Filters at the extreme low and high ends. Select **Kill** for the filter extremes to end in silence, or select **Bleed** to allow the extreme end of the filter to play.
- **FX Noise Volume:** This setting determines the level of the Noise Sweep effect in the mix when active, from **-20** to **15 dB**.
- **Cue Solo Mode:** This setting determines how many channels can be sent to the cue mix. Set to **On** to have only one channel at a time in the cue mix, or set to **Off** to cue multiple channels at a time.
- **Split Cue Output:** This setting determines the stereo positioning of the pre-fader cueing mix and main mix when Split Cue is enabled. When set to **Normal**, the pre-fader cue mix will be stereo left and the main mix will be stereo right. When set to **Invert**, the pre-fader cue mix will be stereo right and the main mix will be stereo left.
- **Split Cue:** This setting enables or disables Split Cue, which will split the stereo signal between the main mix and pre-fader cue mix.
- **Effect Select Behavior:** When set to **Default**, all effects settings will return to their default settings when a new track is loaded. When set to **Recall**, effects settings will be retained.
- **Reset Effects to Default Settings:** Tap here to manually reset effects to the default settings.

Mic

- **Attenuation:** This setting determines the amount of additional attenuation for the **Microphone Inputs**: **-20 dB**, **-10 dB** or **0 dB**.
- **Send to Booth:** This setting determines whether the microphone signal is sent to the booth outputs (**On**) or not (**Off**).

Services

- **Lighting:** This determines whether SoundSwitch Engine Lighting is enabled (**On**) or disabled (**Off**). Tap the **gear icon** to open the lighting control interface.
- **Sync:** This determines whether Ableton Link is enabled (**On**) or disabled (**Off**). Ableton Link synchronizes beat, phase, and tempo of Ableton Live and Ableton Link-enabled applications over a wireless or wired network. You must be connected to the internet to use Ableton Link.
- **Streaming:** Use these options to enable or disable connections to streaming service partners. When set to **On**, the selected service will be available in the **Source** menu.
- **Cloud:** Use this option to retrieve your Engine library database from a cloud storage service. You must first use the Engine DJ software to back up your database. Then, when this option is set to **On**, the selected service will be available in the **Source** menu and you can access these files over an established internet connection.

Note: We recommend using only high-quality, name brand USB 3.0 or Class U1 or U3 SD cards as source drives, especially when cloud services are enabled.

About / Update

This page displays the product name, current firmware version, and other device information.

- **Update Firmware Version:** If you are not running the latest firmware, tap **Reboot** to restart PRIME GO in Update Mode, which enables you to update its firmware. Follow the firmware update instructions included with the firmware update package you downloaded.
- **Send Anonymous Usage Statistics:** This determines whether or not your usage statistics will be sent occasionally to us, enabling us to improve the Engine experience.
- **Factory Reset:** Tap here to restore the default factory settings for your device.
- **Legal:** Tap here to view the Denon DJ EULA and patent list.

SC LIVE 4

Device

- **Deck 3/4:** This determines whether this SC LIVE 4 will use both deck layers (**On**) or just one (**Off**).
- **Wi-Fi:** This determines whether Wi-Fi connectivity is enabled (**On**) or disabled (**Off**). Tap the **gear icon** to open the Wi-Fi settings. See [Wi-Fi](#) for more information about the Wi-Fi menu.
- **Time/Date:** This displays the current local time and date. Tap **Sync Time** when connected to the internet to automatically sync the time.
- **Time Zone:** Displays the current time zone, formatted as **Continent / City**.
- **Set time zone manually:** Enable this setting and then tap the **gear icon** to manually set your local time zone.
- **Track Preview:** When active, Track Preview will reveal a play button for each song in the library, allowing the songs to be auditioned in the cue without loading a song to the deck. Select **On** or **Off**.
- **Preview Volume:** Use this slider to set the volume level of the track preview (**0–100%**).
- **Screen Brightness:** This setting determines the brightness of the main display: **Low**, **Mid**, **High**, or **Max**.

Mixer

- **Sampler Output:** This setting determines where Sampler audio is routed: **Ch 3**, **Ch 1**, **Ch 2**, **Ch 4**, or **Main**.
- **Playlist Deck Crossfade Time:** Use this slider to adjust the amount of crossfade between tracks when using the playlist deck.
- **EQ Type:** This setting determines the type of equalization for the **Channel EQ** knobs. Select **Isolate** for EQ bands with infinite cut for full band "kills," or select **Norm** for EQ bands with limited cut.
- **ISO EQ High Xover:** When EQ Type is set to Isolate, this setting determines the crossover frequency between the Mid and High EQ bands, from **1000** to **8000 Hz**.
- **ISO EQ Low Xover:** When EQ Type is set to Isolate, this setting determines the crossover frequency between the Low and Mid EQ bands, from **100** to **800 Hz**.
- **Filter Resonance:** This setting determines the amount of resonance of the filter, from **0** to **15**.
- **Filter Extreme Type:** This setting determines the effect of the Sweep Filters at the extreme low and high ends. Select **Kill** for the filter extremes to end in silence, or select **Bleed** to allow the extreme end of the filter to play.
- **FX Noise Volume:** This setting sets the level of the **Noise Sweep FX**, from **-20** to **+15 dB**.
- **Cue Solo Mode:** This setting determines how many channels can be sent to the cue mix. Set to **On** to have only one channel at a time in the cue mix, or set to **Off** to cue multiple channels at a time.
- **Split Cue Output:** This setting determines the stereo positioning of the pre-fader cueing mix and main mix when Split Cue is enabled. When set to **Normal**, the pre-fader cue mix will be stereo left and the main mix will be stereo right. When set to **Invert**, the pre-fader cue mix will be stereo right and the main mix will be stereo left.
- **Sum Main Out To Mono:** This setting enables or disables summing the audio to the **Main Outputs** to a mono signal (**On**). When disabled (**Off**), the audio will be sent in stereo.
- **Effect Select Behavior:** When set to **Default**, all effects settings will return to their default settings when a new track is loaded. When set to **Recall**, effects settings will be retained.
- **Reset Effects to Default Settings:** Tap here to manually reset effects to the default settings.

Mic / Aux

- **Send to Speakers:** This setting determines whether the microphone signal is sent to the onboard speakers (**On**) or not (**Off**).
- **Mic Attenuation:** This setting determines the amount of additional attenuation for the **Mic 1** and **2** Inputs: **-20** to **0 dB**.
- **Mic Threshold:** This setting determines the minimum threshold at which the microphone signal will activate the **Talkover** feature, from **-40** to **-1 dB**.
- **Send to Booth:** This setting determines whether the microphone signal is sent to the booth outputs (**On**) or not (**Off**).
- **Send to Headphones:** This setting determines whether the microphone signal is sent to the headphone outputs (**On**) or not (**Off**).
- **Mic 1 / Mic 2 / Aux EQ:** These settings allow you to adjust the **Treble**, **Mid**, and **Bass** equalization for the two microphone signals and aux signal, from **-15.0** to **6.0 dB**.

Services

- **Sync:** This determines whether Ableton Link is enabled (**On**) or disabled (**Off**). Ableton Link synchronizes beat, phase, and tempo of Ableton Live and Ableton Link-enabled applications over a wireless or wired network. You must be connected to the internet to use Ableton Link.
- **Streaming:** Use these options to enable or disable connections to streaming service partners. When set to **On**, the selected service will be available in the **Source** menu.
- **Cloud:** Use this option to retrieve your Engine library database from a cloud storage service. You must first use the Engine DJ software to back up your database. Then, when this option is set to **On**, the selected service will be available in the **Source** menu and you can access these files over an established internet connection.

Note: We recommend using only high-quality, name brand USB 3.0 or Class U1 or U3 SD cards as source drives, especially when cloud services are enabled.

About / Update

This page displays the product name, current firmware version, and other device information.

- **Update Firmware:** If you are not running the latest firmware, tap **Reboot** to restart SC LIVE 4 in Update Mode, which enables you to update its firmware. Follow the firmware update instructions included with the firmware update package you downloaded.
- **Send Anonymous Usage Statistics:** This determines whether or not your usage statistics will be sent occasionally to us, enabling us to improve the Engine experience.
- **Factory Reset:** Tap here to restore the default factory settings for your device.
- **Legal:** Tap here to view the Denon DJ EULA and patent list.

SC LIVE 2

Device

- **Wi-Fi:** This determines whether Wi-Fi connectivity is enabled (**On**) or disabled (**Off**). Tap the **gear icon** to open the Wi-Fi settings. See [Wi-Fi](#) for more information about the Wi-Fi menu.
- **Time/Date:** This displays the current local time and date. Tap **Sync Time** when connected to the internet to automatically sync the time.
- **Time Zone:** Displays the current time zone, formatted as **Continent / City**.
- **Set time zone manually:** Enable this setting and then tap the **gear icon** to manually set your local time zone.
- **Track Preview:** When active, Track Preview will reveal a play button for each song in the library, allowing the songs to be auditioned in the cue without loading a song to the deck. Select **On** or **Off**.
- **Preview Volume:** Use this slider to set the volume level of the track preview (**0–100%**).
- **Screen Brightness:** This setting determines the brightness of the main display: **Low, Mid, High, or Max**.

Mixer

- **Sampler Output:** This setting determines where Sampler audio is routed: **Ch 1, Ch 2, or Main**.
- **Playlist Deck Crossfade Time:** Use this slider to adjust the amount of crossfade between tracks when using the playlist deck.
- **EQ Type:** This setting determines the type of equalization for the **Channel EQ** knobs. Select **Isolate** for EQ bands with infinite cut for full band "kills," or select **Norm** for EQ bands with limited cut.
- **ISO EQ High Xover:** When EQ Type is set to Isolate, this setting determines the crossover frequency between the Mid and High EQ bands, from **1000 to 8000 Hz**.
- **ISO EQ Low Xover:** When EQ Type is set to Isolate, this setting determines the crossover frequency between the Low and Mid EQ bands, from **100 to 800 Hz**.
- **Filter Resonance:** This setting determines the amount of resonance of the filter, from **0 to 15**.
- **Filter Extreme Type:** This setting determines the effect of the Sweep Filters at the extreme low and high ends. Select **Kill** for the filter extremes to end in silence, or select **Bleed** to allow the extreme end of the filter to play.
- **FX Noise Volume:** This setting sets the level of the **Noise Sweep FX**, from **-20 to +15 dB**.
- **Cue Solo Mode:** This setting determines how many channels can be sent to the cue mix. Set to **On** to have only one channel at a time in the cue mix, or set to **Off** to cue multiple channels at a time.
- **Split Cue Output:** This setting determines the stereo positioning of the pre-fader cueing mix and main mix when Split Cue is enabled. When set to **Normal**, the pre-fader cue mix will be stereo left and the main mix will be stereo right. When set to **Invert**, the pre-fader cue mix will be stereo right and the main mix will be stereo left.
- **Sum Main Out To Mono:** This setting enables or disables summing the audio to the **Main Outputs** to a mono signal (**On**). When disabled (**Off**), the audio will be sent in stereo.
- **Effect Select Behavior:** When set to **Default**, all effects settings will return to their default settings when a new track is loaded. When set to **Recall**, effects settings will be retained.
- **Reset Effects to Default Settings:** Tap here to manually reset effects to the default settings.

Mic

- **Send to Speakers:** This setting determines whether the microphone signal is sent to the onboard speakers (**On**) or not (**Off**).
- **Mic Attenuation:** This setting determines the amount of additional attenuation for the **Mic** Input: **-20** to **0 dB**.
- **Mic Threshold:** This setting determines the minimum threshold at which the microphone signal will activate the **Talkover** feature, from **-40** to **-1 dB**.
- **Send to Headphones:** This setting determines whether the microphone signal is sent to the headphone outputs (**On**) or not (**Off**).
- **Mic EQ:** These settings allow you to adjust the **Treble**, **Mid**, and **Bass** equalization for the microphone signal, from **-15.0** to **6.0 dB**.

Services

- **Sync:** This determines whether Ableton Link is enabled (**On**) or disabled (**Off**). Ableton Link synchronizes beat, phase, and tempo of Ableton Live and Ableton Link-enabled applications over a wireless or wired network. You must be connected to the internet to use Ableton Link.
- **Streaming:** Use these options to enable or disable connections to streaming service partners. When set to **On**, the selected service will be available in the **Source** menu.
- **Cloud:** Use this option to retrieve your Engine library database from a cloud storage service. You must first use the Engine DJ software to back up your database. Then, when this option is set to **On**, the selected service will be available in the **Source** menu and you can access these files over an established internet connection.

Note: We recommend using only high-quality, name brand USB 3.0 or Class U1 or U3 SD cards as source drives, especially when cloud services are enabled.

About / Update

This page displays the product name, current firmware version, and other device information.

- **Update Firmware:** If you are not running the latest firmware, tap **Reboot** to restart SC LIVE 2 in Update Mode, which enables you to update its firmware. Follow the firmware update instructions included with the firmware update package you downloaded.
- **Send Anonymous Usage Statistics:** This determines whether or not your usage statistics will be sent occasionally to us, enabling us to improve the Engine experience.
- **Factory Reset:** Tap here to restore the default factory settings for your device.
- **Legal:** Tap here to view the Denon DJ EULA and patent list.

Source

The Source menu allows you to select a connected media device, streaming service, or cloud service for use with your EngineOS hardware. All connected media sources will be shown in the top part of the display, and available streaming and cloud service partners at the bottom of the display.

To select a drive as a media source, tap the device name. The currently selected source device, if any, will show **Source** next to its name. The currently selected recording device, if any, will show **Rec** next to its name.

To select a streaming or cloud service as your source, tap the streaming or cloud service name. If you have not set up a connection to the service yet, you will be prompted to sign in with your username and password or given a web link and code in order to activate your device. Once signed in or activated, you can use the streaming or cloud service to browse and add tracks. Streaming and cloud services may be enabled or disabled in the **Settings** menu.

To open *Wi-Fi* connection menu, tap the **Wi-Fi icon** at the top of the display.

To switch your EngineOS hardware to computer mode, tap the computer icon at the top of the display. In computer mode, you can use your EngineOS hardware to send and receive MIDI messages to and from your computer.

To eject a drive source, tap the eject icon next to the drive name. If a track from the selected source is currently in use, an alert will appear to note that the tracks will be unloaded. Tap **Eject Anyway** to continue or tap **Cancel** to return to the Source menu.

To exit the Source menu, tap the **X** at the top-right of the display.

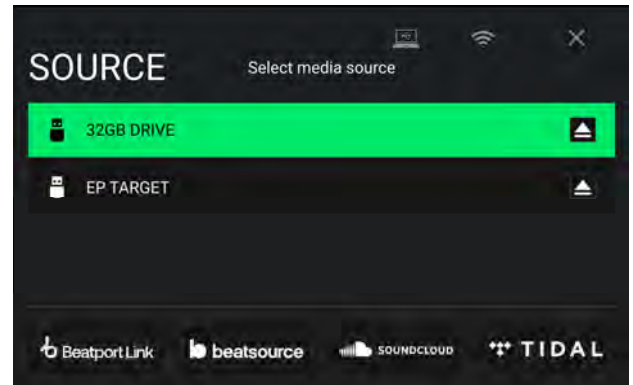

Engine Remote Library

In addition to connected devices, streaming services, and cloud services, you can also connect to an instance of the Engine DJ software running on a computer sharing the same network as your EngineOS hardware. This allows you to browse and load tracks from your complete library without having to pack files to a portable drive.

To access your Engine Remote Library:

1. First, make sure your hardware and your computer are on the same network, and the Engine DJ software is opened. This can be done by connecting to the same Wi-Fi network, or by connecting directly using an Ethernet cable.
2. Tap the **Source** icon in Library View from your hardware, and locate your computer under the **Engine DJ Desktop** section.
3. Tap to select the computer, and your hardware will show “Waiting for confirmation” while another message appears in the Engine DJ software asking to accept or deny access to your hardware. Click **Accept** to approve and continue.

If the connection process is canceled, or if the connection is lost, both libraries will return to their previous selections.

4. Once the connection is established, you will be able to browse and load tracks from your Engine DJ software collection directly from your hardware.
5. When you load a track from the Engine Remote Library, the track will begin downloading over the network. The download progress will be shown on your hardware touchscreen. If the download fails, a “Failed to Download” message will appear on your hardware. You can remotely load tracks up to 250 mb in size.

Tracks will download with any performance data associated with the file in your Engine DJ software collection. This includes beat grids, saved cues, and saved loops. If no beat grid information is included with the downloaded track, your EngineOS hardware will analyze the file once it is loaded.

Any edits made to performance data, track metadata, and playlists from your EngineOS hardware or Engine DJ software will automatically sync to the other.

Wi-Fi

The Wi-Fi page allows you to connect to a local internet network so you can browse connected streaming and cloud services.

To enable Wi-Fi, tap the **Wi-Fi switch** at the top of the page. Once enabled, a list of local networks will appear on the display.

To establish a connection, tap the desired network name. If a password is required, you will be prompted to enter it. Once a connection is established, **Connected** will appear next to the network name.

To view information about the network, tap the **three-dots icon** next to the network name. Tap **Close** or anywhere outside the menu to close the Wi-Fi information menu.

A Wi-Fi connection menu will also appear when your EngineOS hardware is powered on. On this page:

To enable Wi-Fi, tap the **Wi-Fi switch** at the top of the touchscreen.

To establish a connection, tap the desired network name. If a password is required, you will be prompted to enter it. Once a connection is established, the page will be dismissed.

To view information about the network, tap the three-dots icon next to the network name.

To dismiss this page, tap **Close** at the top of the touchscreen.

To prevent this page from appearing each time your hardware is powered on, tap the **Do not show again at startup** box so it is checked.

Record

Select the media device destination that you will use to save your recording. The currently selected source device will show **Source** next to its name. Once you have selected the recording device, you can begin recording your session.

To begin recording, tap **Start**. The timer on the touchscreen will show the total length of time recorded.

To pause recording, tap **Pause**.

To resume recording when paused, tap **Resume**. Your EngineOS hardware will continue recording your session from where you pressed pause.

To stop recording, tap **Stop**. Once recording is stopped, you will have the option of saving the file to your device.

To clear the recording, tap **Clear**. A warning screen will be shown before the file is deleted. Tap **Yes** to continue, or **No** to return to the previous page to save the recording.

To save the recording to your drive, tap **Save As**. A keyboard will appear where you can title your file. Tap **Done** to finish and save your file, or tap **Cancel** to return to the previous page. A success message will be shown on the display when the operation is complete. Tap **OK** to continue, or wait a few seconds and you will be returned to the Record menu.

Recorded files will be saved in a folder called **Sessions** on your media device. You can access these recordings from your EngineOS hardware under the **Files** section of the **Library**.

To move back a page or return to the previous page, tap the **back arrow** (<).

To exit the Record menu, tap the **X**.

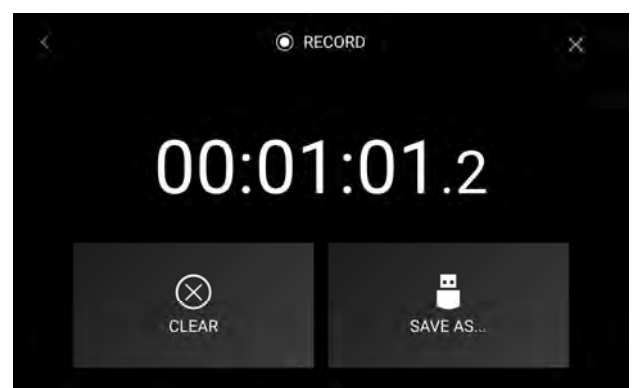
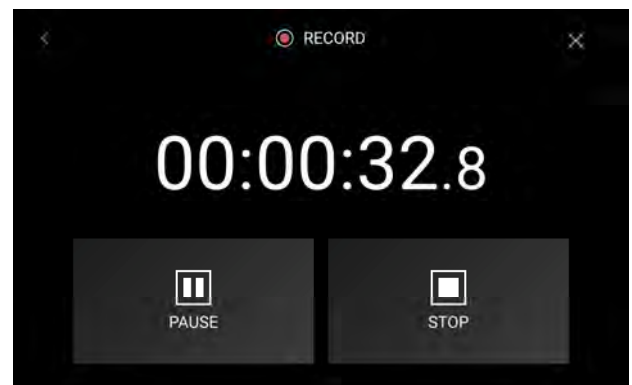
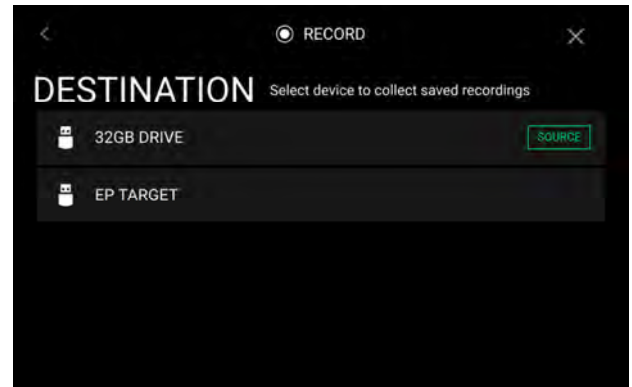

Engine Lighting

The Engine Lighting page allows you to control connected lighting devices such as DMX fixtures and Smart Lights using SoundSwitch to seamlessly sync your music and lights.

Open the Engine Lighting control page by doing one of the following:

- **PRIME 4, PRIME 2, PRIME GO:** When Engine Lighting is enabled within the **Settings** menu, tap the **gear icon** on the **Services** page, or double-press the **View** button.
- **SC LIVE 4, SC LIVE 2:** Press the **Lighting** button.

The first time you use Engine Lighting, you can select a **Basic** or **Pro** layout for performing:

Basic: A simple interface for controlling Smart Lights, Control Color, Blackout and Strobe Lighting FX.

Pro: Full control of all lighting effects for both DMX and Smart Lights, Control Movements, Strobe and more.

You will also be prompted if you want to connect Philips Hue or Nanoleaf Smart Lights when you first use Engine Lighting. This can also be configured later through the Engine Lighting **Preferences** menu.

Visit [soundswitch.com](https://www.soundswitch.com) for more information on using SoundSwitch lighting controls with your EngineOS hardware.

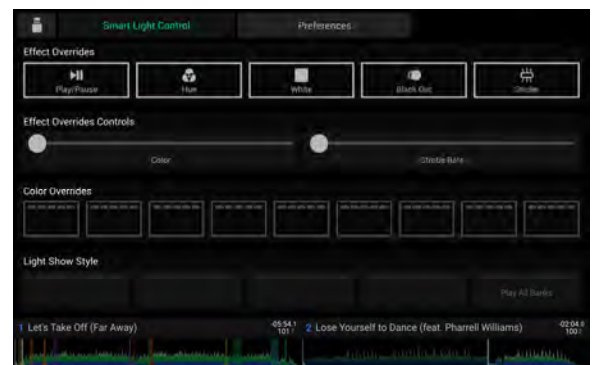

Basic View



Pro View

Preferences

Tap the **Preferences** tab at the top of the touchscreen to open the Engine Lighting preferences.

General

- **Engine Lighting Status:** This setting displays the current connection status to Engine Lighting devices. When **Running** is shown, Engine Lighting is active. Tap **Stop** to deactivate Engine Lighting. Tap **Start** to reactivate.
- **Connection Status:** These indicators will show whether Engine Lighting is receiving signal from up to four connected players.
- **Sync Offset:** Use this slider to apply a time offset for syncing your connected lights, from **-1** to **0** to **+1** seconds.
- **Show Advanced Controls:** Enable this option to toggle between the **Basic** and **Pro** controls.
- **Randomize Autoloops:** This setting determines whether autoloops are randomized or play in order.
- **Override Scripted Tracks:** This setting determines whether a scripted track that is paired with an audio file is used (**Off**) or whether you can override it using the onboard controls (**On**).
- **Loop Auto Strobe:** This setting allows you to automatically generate strobe effects when a Loop Roll is engaged.
- **Broadcast Art-Net:** This setting allows you to enable or disable sending Art-Net protocol to control DMX interfaces over a network connection.
- **Strobes:** This setting determines whether strobe effects are enabled or disabled.
- **Philips Hue:** Enable this option to connect to available Philips Smart Hue devices.
- **Nanoleaf:** Enable this option to connect to available Nanoleaf devices.
- **Active Faders:** This setting allows you to enable or disable Engine Lighting control on up to four channels at a time. Tap the **CH1-CH4** names to activate each channel.
- **Version:** Displays the current Engine Lighting version.

DMX Interfaces

Use this screen to view connected DMX interfaces and their Universe Assignments.

Philips Hue

Use this screen to set up Philips Hue devices.

Nanoleaf

Use this screen to set up Nanoleaf devices.

Appendix

SATA Drive Installation

To create more internal storage space on your PRIME 4 or PRIME 2 hardware, you can purchase a **SATA** (Serial ATA) drive and install it yourself, but read this chapter first.

Your PRIME 4 or PRIME 2 can support nearly any standard 2.5" SATA drive on the market—either a solid-state drive (SSD) or hard-disk drive (HDD). Make sure it uses a **2.5"** (63.5 mm) form factor and uses (or can use) the **exFAT** or **FAT32** file systems.

Note: Alternatively, you could install an **mSATA** (mini-SATA) drive, but make sure you also purchase an adapter that enables it to fit into a typical 2.5" SATA interface.

1. Make sure your PRIME 4 or PRIME 2 hardware is powered **off**.
2. Locate the **SATA drive panel** in the center of the bottom panel of your PRIME 4 or PRIME 2 hardware. Use a Phillips-head screwdriver to remove the screws (don't lose them!), and remove the SATA drive panel.
3. Gently pull the **SATA connector and cable** out from inside your PRIME 4 or PRIME 2 hardware. Be careful not to disturb anything inside—handle just the SATA connector and cable.
4. Connect your **SATA drive** to the **SATA connector**. Make sure the connection is secure.
5. Use four **3x5 mm mounting screws** (included with PRIME 4 or PRIME 2 hardware or with your SATA drive) to secure the SATA drive to the SATA drive panel. Do not overtighten the screws, but make sure the drive is secure and does not shake.
6. Place the SATA drive panel back onto the bottom panel of your PRIME 4 or PRIME 2 hardware, and use the original screws to secure it in place.

You can now access this drive while using your PRIME 4 or PRIME 2 hardware!