

FOS LUMINUS TABLE

USER'S MANUAL

Before you operate this fixture read the manual carefully. Always make sure to include the manual if you pass/rent/sell the fixture to another user.

TABLE OF CONTENT

- 1. WARNING**2
 - 1.1 Safety Instructions2
 - 1.2 Rigging3
- 2. PRODUCT INTRUDUCTION**3
 - 2.1 Items Included in the Tour Pack.3
 - 2.2 Product Overview.....3
 - 2.2.1 Fixture Elements and Connectors4
 - 2.2.2 Fixture Control Panel4
 - 2.2.3 Fixture Dimensions5
 - 2.3 Storing the Fixture5
 - 2.4 Specifications 6
- 3. INSTALLATION**7
- 4 BATTERY CHARGE**8
- 5. PRODUCT SETUP**8
 - 5.1 Menu Navigation9
 - 5.2 DMX Addressing10
 - 5.3 Wireless DMX Setup10
 - 5.4 OLED Display Setup12
 - 5.5 ECO Mode12
 - 5.6 Fixture Information.....12
 - 5.7 Factory Reset12
- 6. OPERATION**12
 - 6.1 DMX Control Mode.....13
 - 6.2 Master/Slave Mode14
 - 6.3 Auto Run Mode14
 - 6.4 Customized Colors.....15
 - 6.5 IR Remote Control.....15
- 7. MAINTENANCE**16
- 8. WARRANTY**.....17

1. WARNING

1.1 Safety Instructions

This product guide contains important information about the safe installation and use of this product. Please read and follow these instructions carefully and keep this manual in a safe place for future reference.

When unpacking and before disposing of the carton, check there is no transportation damage before using the product. Should there be any damage caused by transportation, consult your dealer and do not use the apparatus.

The product is for indoor use only. Use only in dry locations. Keep this device away from rain and moisture, excessive heat, humidity and dust. Do not allow contact with water or any other liquids. The product is not designed or intended to be mounted directly on to inflammable surfaces. 

The product is only intended for installation, operation and maintenance by qualified personnel.

The product must be installed in a location with adequate ventilation, at least 50cm from adjacent wall surfaces. Be sure that no ventilation slots are blocked.

Do not directly look into the led. It can cause harm to your eyes. Do not look at the LEDs with a magnifying glass or any other optical instrument that may concentrate the light output.

Do not attempt to dismantle and/or modify the product in any way.

Electrical connection must only be carried out by qualified personnel.

Before charging the fixture, ensure that the voltage and frequency of power supply match the power requirements of the product.

Do not directly look into the light beam. It can cause harm to your eyes. Do not look at the led with a magnifying glass or any other optical instrument that may concentrate the light output.

A rechargeable lithium ion battery is built inside this fixture. Please avoid bumping or plunging, it may cause fire or explosion. Never store the battery when fully drained. Always recharge immediately when empty. Make sure to fully charge all fixtures before storing them. Partially charged batteries will lose capacity. Fully recharge every 6 months if not used.

When charging fixtures in flight case, always charge with the case open. It is recommended to charge at a temperature between 0°C and 35°C.

Please make sure the battery will be disposed of properly according to your local law when it runs out of its life, so that to protect the environment.

This product is not designed for permanent operation. Consistent operation breaks will ensure that the device will serve you for a long time without defects.

If this fixture is operated in any other way other than the one said in this manual, this device may suffer damages and thus the warranty becomes void.

Always switch off the fixture when it is not in use or before cleaning it or before attempting any maintenance work.

IMPORTANT:

The manufacturer will not accept liability for any resulting damages caused by the non-observance of this manual or any unauthorized modification to the fixture.

1.2 Rigging

Concerning rigging, trussing for this fixture, please follow the European and national guidelines.

Only the qualified technicians are allowed for the device installation,

The fixture must never be mounted for a possible swinging position, and a safety cord attached must always be used.

2. PRODUCT INTRODUCTION**2.1 Items Included in Tour Pack**

After receiving the fixture, please carefully unpack the product and make sure the following parts are all included inside the package and are all in good condition.

- Table light Q6 x 4 pcs
- ABS case x 1 pcs
- Extension x 4 pcs
- IR controller x 4 pcs
- Power station x 1 pcs
- Power cable x 1 pcs
- This manual x 1 pcs

In case the package is damaged from shipping, inform the carrier right away while keeping the damaged box for inspection. Failure to report damage to the carrier immediately may cause invalidity to your claim. The dealer or manufacture will not take any responsibilities for the damage.

In case there are parts missing from the box with a good condition, please contact your dealer or the manufacturer immediately by email or in other written form.

2.2 Product Overview

Table light Q6 is a battery power unit to light up dinner table, no matter for banquet or any other events. It has 6 RGB full color led and also 6 white led with high CRI. This table light can cover 360 degrees of your table and create fantastic atmosphere of any event both indoor and outdoor. Its battery can work up to 10

hours in auto run mode and around 12 hours in running single color.

Table light Q6 can operate in wireless DMX mode, Master/Slave mode, and also in auto run mode. IR controller is supplied to make remote control as well.

Its magnetic base helps it to stand right in the center of table or on any metal surface. You can also put it on top of metal spike in your garden as a garden light.

Table light Q6 is rated IP54. It is therefore suitable for indoor and outdoor applications.

2.2.1 Fixture Elements and Connectors

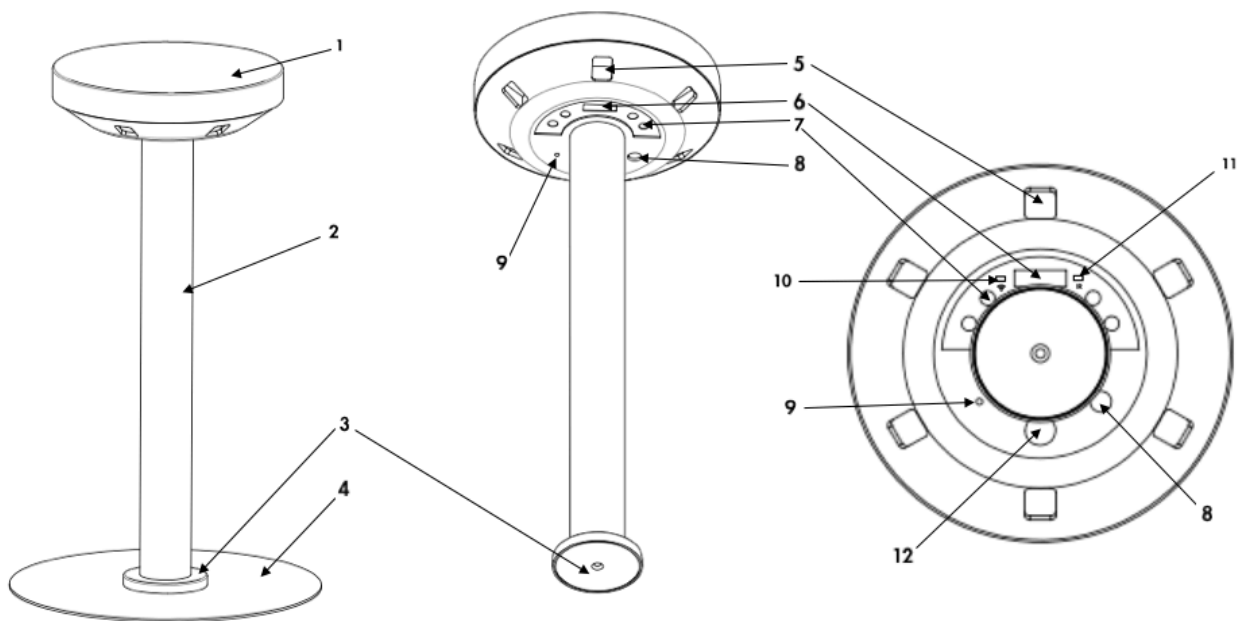

- | | | |
|--|--|---------------------------|
| 1. Removable top cover | 2. Battery tube, also extensible with another tube | |
| 3. Magnetic base for mounting to any metal surface | 4. Metal plate | |
| 5. Led | 6. OLED display | 7. Touch button for setup |
| 8. DC charge port | 9. Antenna for wireless DMX transceiver | |
| 10. Wireless DMX indicator (blue led) | 11. IR sensor | 12. Power switch |

2.2.2 Fixture Control Panel

There are 4 touch buttons on the OLED control panel: **<MENU>**, **<ENTER>**, **<UP>** and **<DOWN>**.

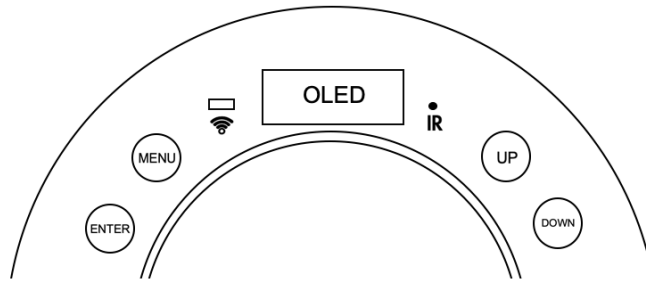

1. Menu to select the programming functions
2. Enter Enter the current menu or confirm the current function value
3. Up Scroll "UP" through the menu list to increase the value of the current function
4. Down Scroll "DOWN" through the menu list to decrease value of the current function

2.2.3 Fixture Dimensions

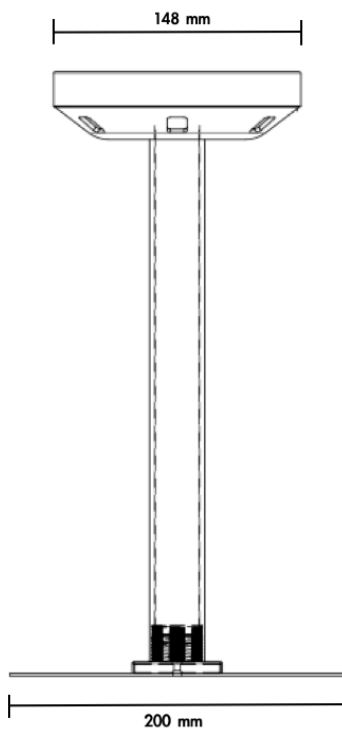

Fixture

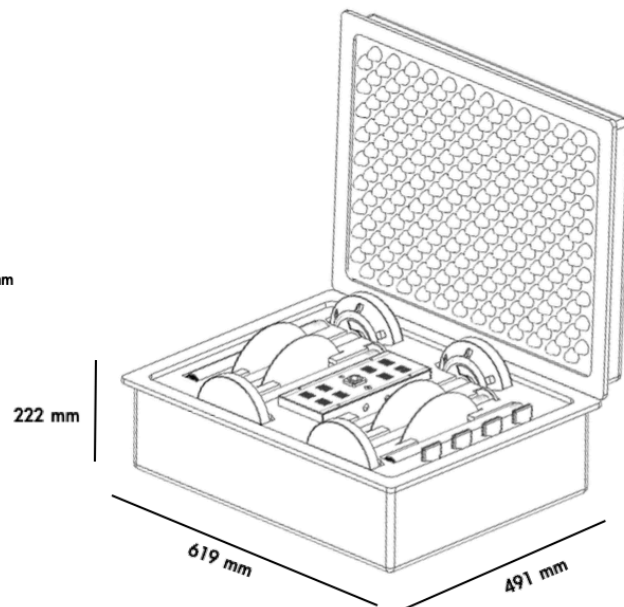

Tour Pack

2.3 Storing the Fixture

Make sure to fully charge all fixtures before storing. Partially charged batteries will lose capacity. Fully recharge every 6 months if not used.

2.4 Specifications

Electrical

Power input	100-240VAC 50/60Hz
Power consumption	15W max.
Power input/output connector	Magnetic DC connector

Battery

Battery	11.1V 8.8Ah
Charge time	About 4.5 hours
Battery life	Around 5 hours at full color from one full charge Around 10 hours for auto color mixing Around 15 hours at running single color
Battery capacity	Percentage shown on OLED display

Light sources

Led	6x3W, RGB 3-in-1, 6x1W white led, CT6000~6500K
White led CRI	>90Ra
Beam angle	360° coverage
Led average life span	50,000 hours

Program

7 static color + 10 dynamic colors
 Linear dimming 0-100% electronic dimmer
 Built-in dimming curves
 Strobe 0~25K Hz
 Built-in color temperatures available
 Customized program savable

Control

DMX protocol	Wireless DMX (transceiver)
Control mode	Master/Slave, Stand Alone; Wireless DMX, IR Remote Control
DMX channel	4/6/10 channel selectable
Control panel	OLED display with touch buttons

Physical & Construction

Housing	Die-cast aluminum and ABS
Housing finish	Mirror finish
Fixture dimensions (WxHxD)	147x345x200mm
Net weight	1.5 kg
Working temperature	-10°C - 45°C
Charge temperature	0°C - 45°C
IP rating	IP54
Cooling	Natural cooling, silent operation

3 INSTALLATION

The fixture can be mounted to any metal surface.

- 3.1 The table light can be placed on the enclosed metal plate on dinner table. Put the metal plate on dinner table or underneath tablecloth, put your table light to the center of the metal plate.
- 3.2 The table light can also be attached to any solid metal surface. Make sure the surface is flat and table light magnetic base can be attached to it safely.
- 3.3 Users can also place table light on top of our spike (sold separately), thus temporarily use the table light as garden light.
- 3.4 The table light battery tube can be extended with another tube to make the height double.

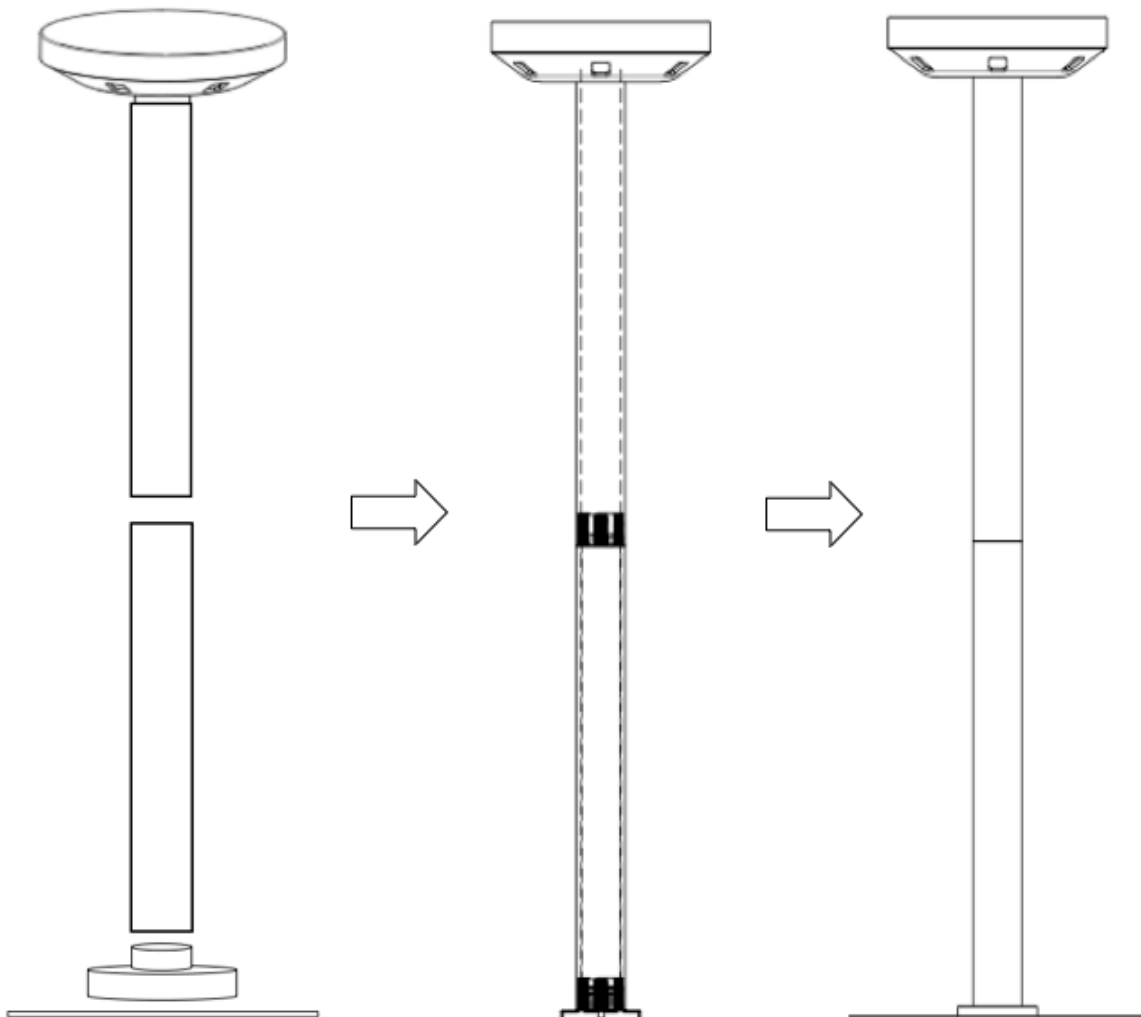

4. BATTERY CHARGE

The fixture has a rechargeable lithium battery built in. Always store the fixtures with full battery. Depleted batteries must be recharged immediately; otherwise fixture performance will suffer.

Battery runtime will decreased time by time. Battery runtime may be slightly shorter than predicted due to different working enviroments.

The fixture has a magnetic DC charge connector. To charge your table light, connect it to the magnetic connector from the power station in the tour pack ABS case. and plug the power station to the mains. The fixture will start to charge automatically. A normal charging time is about 4-5 hours.

Led turns on RED with very little intensity during charging time, and will turn to GREEN once battery is fully charged.

Battery capacity can be easily seen on the OLED display.

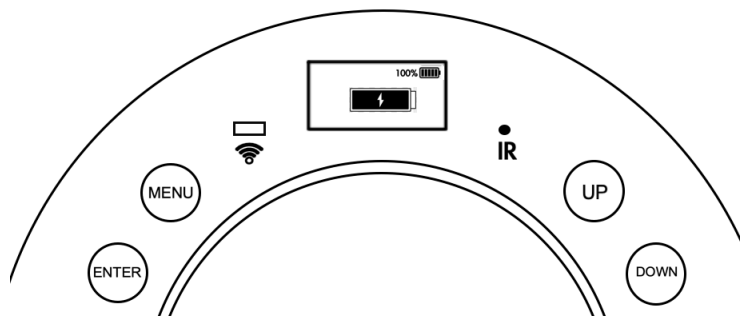

It is recommended to charge the fixture at an ambient temperature between 0°C and 35°C.

When charging fixtures in the tour pack ABS case, make sure to keep the case open. If fixture is charged but not in operation, please always keep the power switch "Off".

Note: The battery must be replaced with an original one from the manufacturer only.

5. PRODUCT SETUP

5.1 Menu Navigation

Menu	Sub-menu	Up/Down	Enter	Remarks
DMX Address	001 - 512			DMX address 001-512
DMX Channel	4CH			DMX channel mode
	6CH			
	10CH			
DMX Fail	Hold			DMX Fail Mode
	Blackout			
	Auto			
Frequency	600Hz			LED refresh rate setting
	1200Hz			
	2000Hz			
	4000Hz			
	25K Hz			
Manual color	R	000-255	Strobe 0-9	Customized color + strobe
	G	000-255		
	B	000-255		
	White	000-255		
Program	Static	Color 01	Strobe 0-9	Static colors + strobe
		Color 02		
			
		Color 15		
	Fade	Dimmer 1	Speed 01-10	4 dimming curves
Dimmer 2				
Dimmer 3				
Dimmer 4				
Auto	Program 1	Speed 01-10	Dynamic effects	
	Program 2			
	Program 3			
	Program 4			
Wireless DMX	On	Transmitter (Master)		Pairing to Slave units
	Off			
	Connect			
	Clear All	Receiver (Slave)		Erase memory for all units
	On			
	Off			
Clear		Clear its own memory only		
Backlight	Always On			OLED display backlight
	10S			
	20S			
	30S			
ECO Mode	Off			Economy mode setting
	On			
IR Setting	On			IR setting
	Off			
Menu Lock	Off			Menu lock setting
	On			
Information	Version	V1.00		Software version
	Current Time	H M S		Current run time
	Total Time	H M S		Total run time
	Temperature	C		Fixture temperature
Factory Reset	No			Factory default setting
	Yes			

5.2 DMX Addressing

Each fixture must be given a DMX address so that the correct fixture responds to the correct control signals. This DMX address is the channel number from which the fixture starts to "listen" to the digital control information being sent out from the controller.

This fixture has 3 DMX channel modes, 4, 6 and 10 DMX channels. To set up fixture DMX address, first select DMX channel mode. The highest DMX address for this fixture is 512. To set up fixture DMX starting address, follow the steps below:

- Switch on the fixture, press MENU till "Channel" appears;
- Press "UP" or "DOWN" button to select 4CH or 6CH or 10CH;
- Press "ENTER" to confirm your select.
- Press "MENU" repeatedly to come back to "Address 001";
- Set up DMX address by scrolling "UP"/"DOWN" button.
- Press "ENTER" to save your setting.

5.3 Wireless DMX Setup

To operate the table light in DMX mode, users must connect it to a W-DMX compatible wireless DMX transmitter first.

There is one wireless DMX indicator on the control panel. This indicator shows status of wireless DMX connection.

Indicator Status	Description
Blue light on	Fixture receiving wireless DMX signal from transmitter.
Blue light slow flashing	Fixture already connected to transmitter, but no signal coming from transmitter.
Blue light fast flashing	Fixture no connection to transmitter; fixture keeps. Wireless DMX memory from last pair.
Blue light off	Fixture no connection to transmitter, and no any wireless DMX memory.

5.3.1 Erase Fixture Wireless DMX Memory

To connect table light to a NEW wireless DMX transmitter, users need to clear old wireless DMX memory first. Continue pressing "MENU" button till you see "Wireless DMX", now press "UP/DOWN" to select "Clear" and press "ENTER" to erase old wireless DMX memory. Then the blue light will turn off in about 5 seconds.

If you clear the wireless DMX memory of a Master unit, you will also clear the memory of all Slave units; If you clear the wireless DMX memory of one Slave unit, you will clear the memory of this unit only.

5.3.2 Connect Fixture to a Wireless DMX Transmitter

After fixture is switched on, and if there is no new transmitter, fixture will connect to the old transmitter automatically, no need to re-connect it.

To put table light into wireless DMX, receive mode, press MENU button repeatedly until you see "Wireless DMX", press ENTER to select [Transmit] / [Receive]. Press UP/DOWN to select [Receive], and press ENTER to save the setting.

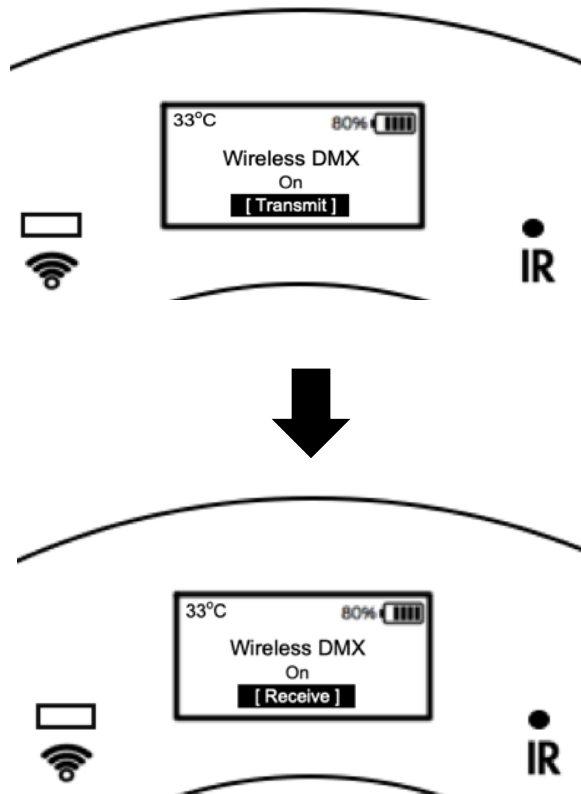

To pair fixture and transmitter (make sure wireless DMX indicator is Off), press the pair button on the transmitter, the fixture wireless DMX indicator will start to fast flashing fast and then stay on, pair succeeds.

5.3.3 Connect Fixture to Fixture(s) (Master/Slave mode)

Make sure you have already cleared the fixtures wireless DMX memory (Please refer to 5.4.1 Erase Fixture Wireless DMX Memory). To set one fixture as Master unit, press MENU button until you see "Wireless DMX" on the OLED display. Then press ENTER button and use UP/DOWN button to select "Transmit". Now press ENTER to save your setting. Now you can select the preset programs.

To set other fixtures as Slave unit, press MENU button until you see "Wireless DMX" on the OLED display. Then press ENTER button and use UP/DOWN button to select "Receive". Press ENTER to save your setting. The fixture(s) now will run in sequence with the Master unit.

Note: Make sure that all your slave units are set to the same DMX channel mode with the Master unit.

5.4 OLED Display Protection

OLED display can be set to turn off in 10-30 second or always "On".

Follow below steps:

- Continue pressing "MENU" till "Back Light" appears.
- Press "ENTER" you will see "Always On", you can scroll up/down to set up the time for OLED display back light to turn off, or always "On"
- Press "ENTER" to save your setting.

5.5 ECO Mode

Fixture can be set to operate at ECO mode. Battery will run longer time with 3 or more color program while brightness is slightly reduced at ECO mode.

To set fixture to run at ECO mode,

- Press MENU button repeatedly until "ECO Mode" appears;
- Press UP/DOWN button to select "On";
- Press ENTER button to confirm your setting.

5.6 Fixture Information

To view all the information of the fixture, please follow the steps below:

- Press MENU button repeatedly until "Information" appears;
- Press UP/DOWN button to view information options: Version – Current Time – Total Time - Temperature;
- Press ENTER button to see the details of each option;
- To exit out of any above options, press MENU button.

Version: Currently installed software version for this fixture;

Current Time: Current operating time of this fixture;

Total Time: Total operating time of this fixture;

Temperature: Current temperature inside the head of this fixture.

5.7 Factory Reset

To reset the fixture to factory default, continue pressing MENU button until "Factory Reset" appears. Now press UP/DOWN button to select [Yes], then press ENTER to confirm your setting.

6. OPERATION

6.1 DMX Control Mode

This function will allow users to control individual fixture with a standard DMX 512 console. Below is fixture DMX Channel Chart.

Channel Mode	Channel	Function	DMX Value	Description
4 CH	1	Red	0-255	0-100%
	2	Green	0-255	0-100%
	3	Blue	0-255	0-100%
	4	White	0-255	0-100%
6 CH	1	Dimming	0-255	0-100%
	2	Red	0-255	0-100%
	3	Green	0-255	0-100%
	4	Blue	0-255	0-100%
	5	White	0-255	0-100%
	6	Strobe	0-10	No function
	11-255		Strobe from slow to fast	
10 CH	1	Dimming	0-255	0-100%
	2	Red	0-255	0-100%
	3	Green	0-255	0-100%
	4	Blue	0-255	0-100%
	5	White	0-255	0-100%
	6	Strobe	0-10	No function
			11-255	Strobe from slow to fast
	7	Colors macro & white balance	0-10	No function
			11-30	R:100% G:0-100% B: 0
			31-50	R: 100%-0 G:100% B: 0
			51-70	R:0 G:100% B: 0-100%
			71-90	R: 0 G: 100%-0 B: 100%
			91-110	R: 0-100% G:0 B: 100%
			111-130	R: 100% G: 0 B: 100%-0
			131-150	R: 100% G: 0-100% B: 0-100%
			151-170	R: 100%-0 G:100%-0 B: 100%
			171-200	R: 100% G: 100% B:100%
			201-205	White 1
			206-210	White 2
			211-215	White 3
216-220			White 4	
221-225	White 5			
226-230	White 6			
231-235	White 7			

10 CH	7	Colors macro & white balance	236-240	White 8
			241-245	White 9
			246-250	White 10
			251-255	White 11
	8	Color temperature	0-5	No function
			6-25	R:255 G:215 B:076 A:251
			26-50	R:255 G:236 B:095 A:252
			51-75	R:249 G:249 B:108 A:253
			76-100	R:229 G:255 B:125 A:239
			101-125	R:197 G:242 B:133 A:207
			126-150	R:187 G:235 B:136 A:191
			151-175	R:169 G:236 B:148 A:207
			176-200	R:168 G:240 B:156 A:204
			201-225	R:167 G:244 B:165 A:201
			226-250	R:167 G:255 B:183 A:192
			251-255	No function
	9	Auto	0-10	No function
			11-60	RGB color fade
			61-110	RGBW color fade
			111-160	RGB color auto mixing
			161-130	RGBACMY color mixing
			131-160	RGB color changing
			161-210	RGBW color auto mixing
			211-255	Sound control
	10	Speed	0-255	From slow to fast

6.2 Master/Slave Mode

The fixture has a built-in wireless DMX transceiver inside. Fixtures can operate Master/Slave mode wirelessly. In Master/Slave mode, one fixture will work as Master fixture, other fixtures in the daisy chain will work in synchronization with the Master fixture.

To operate the fixtures in Master/Slave mode, please refer to **5.4.3 Connect Fixture to Fixture(s) (Master/Slave mode)**.

6.3 Auto Run Mode

The fixture has preset color mixing and fading programs that can be activated from the OLED control panel for auto running. To access this, follow below steps:

- Press button "MENU" repeatedly until "Program" appears.

- Press "UP" or "DOWN" to scroll up/down to select "Auto";
- Press "ENTER" to select from "Program 1" to "Program 4";
- Press ENTER to confirm your setting;
- Press ENTER again to adjust auto run speed (from 01 -09).

To exit out of any above options, press MENU button.

6.4 Customized Colors

Users are allowed to program their own color effects and save to the fixture. Follow the steps below:

- Press button "MENU" repeatedly until "Custom" appears.
- Press "ENTER", you will see "[Red] 255", this means you now can program red color, press again "ENTER" and scroll "UP" or "DOWN" to adjust red intensity, press "ENTER" again to save your setting.

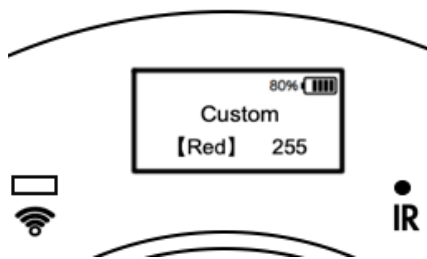

- To select other colors, press MENU to exit from current submenu till you see color menu is selectable. Press "UP" or "DOWN" to select the desired color, Press ENTER button to come to next step. Now press "UP" or "DOWN" button to adjust color intensity value. Now press "ENTER" to confirm the color intensity selected.

6.5 IR Remote Control







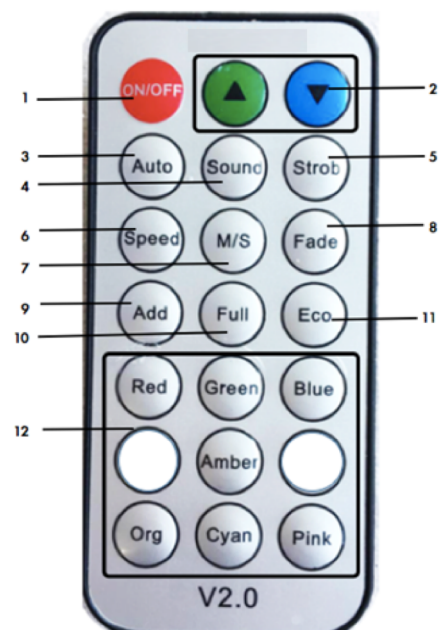











This operation mode allows users to control the fixture with an infrared remote controller. The remote controller can help you to achieve almost all functions.

To activate IR remote control, press "Menu" until "IR" appears, press "Up" or "Down" button and select "On". Press "Enter" to save the setting.

To control the fixture with this IR remote controller, make sure to point the controller directly to the IR receiving sensors on the product. Make sure there are no objects between the controller and



the fixture.

- 1 - Set the fixture into blackout (LED on/off).
- 2 - Adjust auto, strobe & fade speed, sound sensitivity, DMX address, DMX channel, brightness etc.
- 3 - Run auto mode, use "Speed" button followed by the   buttons to adjust auto speeds.
- 4 - Run sound program, use   buttons to adjust sound sensitivity.
- 5 - Run strobe program, use   buttons to adjust strobe speed.
- 6 - Set auto/fade speed, Press this button followed by   buttons to adjust program speed.
- 7 - Set the fixture into master or slave mode.
- 8 - Run fade mode. Use "Speed" button followed by   buttons to adjust fade speed.
- 9 - Set DMX address. Press this button followed by   to set up DMX address. Press this button again followed by   to select DMX channel.
- 10 - Set the fixture in full brightness. Press this button followed by   buttons to adjust brightness.
- 11 - Set the fixture in Economy mode. Press this button followed by   buttons to turn Economy mode on/off.
- 12 - Set static color. This fixture has RGBA led, so "White" and "UV" buttons are invalid.

7. MAINTENANCE

The operator has to make sure that the safety-related and machine-technical installations are to be inspected by an expert once a year in the course of an acceptance test.

The operator has to make sure that safety-related and machine-technical installations are to be inspected by a skilled person once a year.

The following points have to be considered during the inspection:

- Make sure connections are clean and totally dry before linking equipments or supplying electric power.
- All screws used for installing the fixture or parts of the fixture have to be tightly connected and must not be corroded.

The fixture has optical lenses; users should clean the lenses periodically to optimize light output. The cleaning frequency depends on the environment in which the curtain system is installed. Damp, smoky or particularly dirty surrounding can cause greater accumulation of dirt on the lenses. Even in a clean type of surroundings, it is suggested to clean the lens and housing at least once a month. It is suggested to use a soft cloth using normal glass cleaning fluid.

The following points have to be considered during the maintenance:

- Switch off the fixture before cleaning.
- Clean the lens with a mild solution of glass cleaner or isopropyl alcohol, and a soft, lint free cotton cloth or a lens cleaning tissue.
- Gently polish the external glass surfaces until they are free of haze and lint.

8. WARRANTY

The manufacturer hereby warrants, to the original purchaser, our products to be free of manufacturing defects in material and workmanship for a period of one year (365 days) from the date of purchase. It is the owner's responsibility to establish the date and place of purchase by acceptable evidence, at the time service is sought. This warranty is void if the serial number has been altered or removed; if the product is modified in any manner that the manufacturer concludes, after inspecting, affects the reliability of the product; if the product has been repaired or serviced by anyone other than the manufacturer unless prior written authorization was issued to purchaser by the manufacturer. If the product is damaged because not properly maintained as set forth in the instruction manual. No warranty, whether expressed or implied, is given or made with respect to any accessory supplier with products described above. The consumer's and or Dealer's sole remedy shall be such repair or replacement as is expressly provided.; and under no circumstances shall the manufacturer be liable for any loss or damage, direct or consequential, arising out of the use of, or inability to use, this product. This warranty is the only written warranty applicable to the manufacturer. Products and supersedes all prior warranties and written descriptions of warranty terms and conditions heretofore published. The manufacturer reserves the right to make changes in design and/or improvements upon its products without any obligation to include these changes in any products theretofore manufactured.

FOS LUMINUS TABLE USER'S MANUAL

Dealer Info.



Copyright reserved

Manual version: Ver. 1.0

Date: 20220822