

# DECO22

Deco series: triangular aluminium series

ISO DIN 4113 and TÜV certified.

Made of 35mm aluminium alloy (AL 6060-T diameter 35 mm, thickness 1.6 mm).

This is the series you need for your shop, exhibition stand or decorations.

This structure is supplied with :

- 1 x bar connection kit
- 1 x 2 directions angle connection kit
- 2 x 3 and 4-direction angle connection

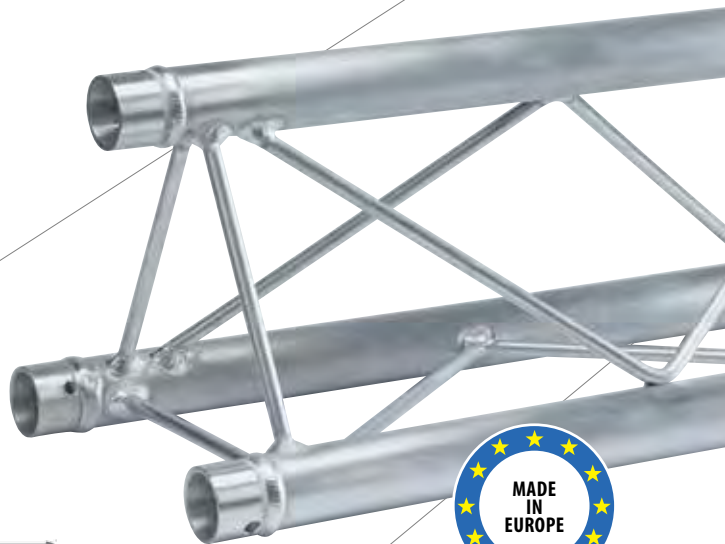
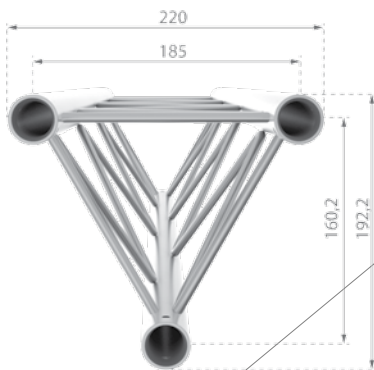

## DECO22T-PT50

ref 10229

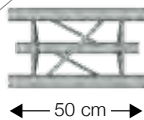

## DECO22T-PT100

ref10230

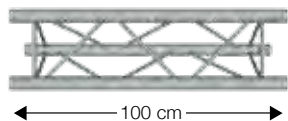

## DECO22T-PT200

ref 10231

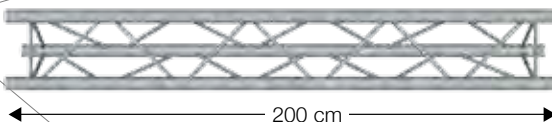





LENGTH (M)		1	2	3	4	5	6
Max load (center) (kg)		263,98	198,09	158,52	132,12	113,27	99,12
Distortion (mm)		0,3	1,6	4,3	8,6	14,3	21,7
Max distributed load (kg/m)		365	182	121	90,50	59,16	40,78
Distortion (mm)		0,2	1,8	6,2	14,7	23,4	33,5

Table loads indicate the maximum load-bearing capacity between two fixation points. Centered and distributed loads cannot be cumulated. Talk to a qualified engineer for more information.



**CORNER JOINTS**

DECO22T-**AG01**

ref 10232

DECO22T-**AG02**

ref 10233

DECO22T-**AG03**

ref 10234

DECO22T-**AG04**

ref 10235

DECO22T-**AG05**

ref 10331

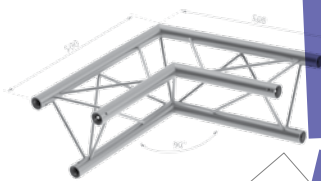
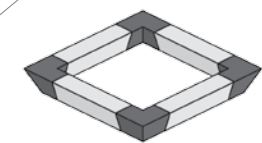

+ 220 mm angle  
+ 2 directions  
90°

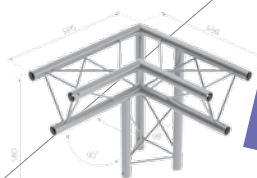
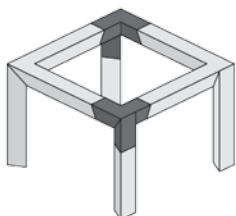

+ 220 mm angle  
+ 3 directions  
+ 3 x90° right-oriented

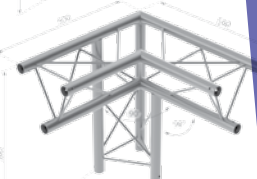
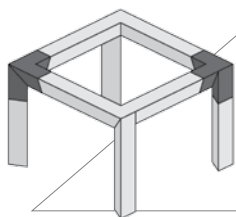

+ 220 mm angle  
+ 3 directions  
+ 3x90° left-oriented

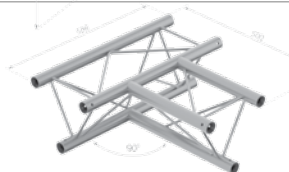
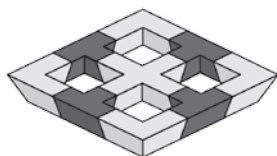

+ 220 mm angle  
+ 3 directions  
+ 3 x90° flat

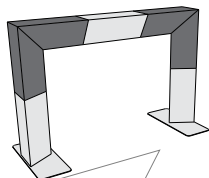

+ 220mm angle  
+ 2 directions  
+ 2x90 vertical directions

**LES ACCESSOIRES DECO22**

**1. DECO22T-MCKIT**

3 connectors, 6 safety pins and 6 pins kit  
ref 10236

**2. DECO22T-EM-B1**

Baseplate with fasteners for DECOtrio series  
ref 10237

**3. DECO22T-EM-B2**

Rectangular baseplate for Deco trusses - For 35mm pipes  
ref 10333

**4. DECO22-CLAV**

Pin for DECO series conical connectors  
ref 10227

**5. DECO22-MANCH**

Conical connector for Déco series aluminium structure  
ref 10226

**6. DECO22-1/2MANCH**

M8 conical half-connector for 35mm tube  
ref 10332

**7. DECO22-GOUP**

Safety pin for Déco series  
ref 10228

**NEW**

1.



2.

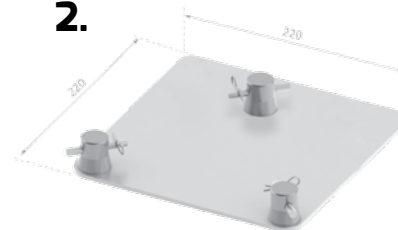

3.

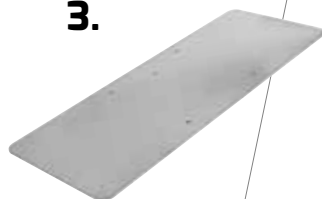

**NEW**

4.



5.



6.



**NEW**

7.

