

## MAGICFX® CO2 POWER JET



PRODUCT CODE : MFX1160  
VERSION : 1.0  
DATE : 11.12.2012



## 1. CONGRATULATIONS!

You have bought a great new product from MAGICFX®.

MAGIC FX is a Dutch manufacturer of professional special effects machines and equipment. We have been experts in special effects since our establishment in 1995. All our products are made under the brand name MAGICFX® which by now has acquired a great reputation on account of its quality and reliability. All products are made in accordance with the European Machinery Directive. MAGIC FX manages the entire production process in-house, from the design stages and prototyping to production. In short, we cover everything from concept to ready-to-use product.



Moreover, MAGIC FX is Europe's largest supplier of high-quality and fireproof confetti products and streamers. Thanks to our very large stock levels, we can deliver quickly and at low prices.

MAGICFX® is used by special effects professionals all over the world and our products are distributed through a dealer network which covers more than 80 countries.

Congratulations and enjoy your purchase!

# MAGIC:CFX®

## 2. CE MARKING

	<p><b>PLEASE NOTE:</b> We presume that you, your employees and others who use or come into contact with the machine are familiar with how the machine must be dealt with. This includes the correct use, maintenance and repair of the machine as described in this user manual. This also means that the employees are familiar with the use of machines through training or experience.</p>
	<p><b>DANGER WARNING:</b> Only use the CO2 Power Jet in accordance with the regulations and instructions in this manual. Consult MAGIC FX in case of doubt.</p>

Disclaimers:

MAGIC FX B.V. excludes liability for unsafe situations, accidents and damage that are the result of:

- Disregard for the warnings or regulations as set out on the CO2 Power Jet or in this documentation.
- Use for other purposes or under other circumstances than those set out in this documentation.
- Alterations to the CO2 Power Jet. This also includes the use of replacement parts other than the original ones.
- Insufficient maintenance.
- Unauthorised removal of safety caps and/or safeguards.
- Incompetent operation of the machine.

MAGIC FX B.V. is not liable for any consequential loss in the event of a CO2 Power Jet breakdown.

© Copyright 2012

All rights are reserved. Nothing from this manual may be duplicated, or kept in an automated data file, or made public, or in any form or manner, whether electronically, mechanically, by photocopying, by incorporation, or in any other manner duplicated without the permission of MAGIC FX B.V.

MAGIC FX at all times retains the right to make alterations without the direct knowledge of the client. The contents of this user manual can also be changed.

Please contact the technical department of your supplier for extra information with regard to, for example, maintenance and repair. This user manual has been drawn up with the utmost care. MAGIC FX cannot be held responsible for any mistakes made in this publication or for any consequences thereof.

### 3. DECLARATION OF CONFORMITY

---

**DECLARATION OF CONFORMITY**  
(according to Annex II.1.A of the Machinery Directive)



Concerning the Machinery Directive.

We; MAGIC FX B.V.

Schouwrooij 27

5281 RE Boxtel

The Netherlands

State under personal responsibility:

We are the manufacturer of the product:

**MFX1160 - MAGICFX® CO2 Power Jet**

to which this statement relates and which is in accordance with the provisions of the following Directive(s):

- Machinery Directive 2006/42/EC
- Low Voltage Directive 2006/95/EC
- EMC Directive 2004/108/EG
- Pressure Equipment Directive 97/23/EC

The following harmonising standards have been applied:

- NEN-EN-ISO 12100
- NEN-EN-ISO 60204-1

Place : Boxtel

Date : 18-10-2012

Name: MAGIC FX

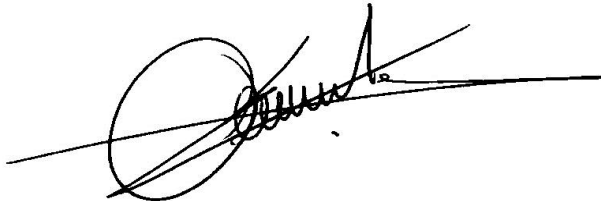

Director: B. Veroude





## 4. FOREWORD

This manual describes the MAGICFX® CO2 Power Jet. The information in this manual is important for the proper and safe functioning of the CO2 Power Jet. If you are not familiar with the installation, operation, preventative maintenance etc. of the CO2 Power Jet then please read this user manual carefully from beginning to end. MAGIC FX also insists that all new users (operators, installers, maintenance workers and cleaners) receive a training course in which this user manual can serve as a starting point.

MAGIC FX advises that the original of this user manual, including appendices, is kept at a safe and central place. It is best that another original or copy is kept close to the CO2 Power Jet at the workplace.

If you are familiar with these matters, then you can use this manual as a work of reference.

The following standard markings are used in this manual for drawing attention to certain subjects or actions.

	<p><b>TIP:</b>  <b>Gives you suggestions and advice regarding easier or more convenient ways to carry out certain tasks.</b></p>
	<p><b>PLEASE NOTE:</b>  <b>A comment with additional information: alerts you to certain problems.</b></p>
	<p><b>CAUTION:</b>  <b>The machine can be damaged if you do not follow the procedures carefully.</b></p>
	<p><b>DANGER WARNING:</b>  <b>You can get (seriously) hurt if you do not carefully carry out the procedures.</b></p>

## CONTENTS

<b>1.</b>	<b>CONGRATULATIONS!</b> .....	<b>1</b>
<b>2.</b>	<b>CE MARKING</b> .....	<b>2</b>
<b>3.</b>	<b>DECLARATION OF CONFORMITY</b> .....	<b>3</b>
<b>4.</b>	<b>FOREWORD</b> .....	<b>4</b>
<b>5.</b>	<b>INLEIDING</b> ..... FOUT! BLADWIJZER NIET GEDEFINIEERD.	
<b>5.1</b>	<b>BESCHRIJVING CO2 POWER JET EN TOEPASSING</b> ..... FOUT! BLADWIJZER NIET GEDEFINIEERD.	
<b>5.2</b>	<b>NOODZAKELIJKE TOEBEHOREN</b> ..... FOUT! BLADWIJZER NIET GEDEFINIEERD.	
<b>6.</b>	<b>VEILIGHEID</b> .....	<b>FOUT! BLADWIJZER NIET GEDEFINIEERD.</b>
<b>6.1</b>	<b>INLEIDING</b> ..... FOUT! BLADWIJZER NIET GEDEFINIEERD.	
<b>6.2</b>	<b>ALGEMENE VEILIGHEIDSREGELS</b> ..... FOUT! BLADWIJZER NIET GEDEFINIEERD.	
<b>6.3</b>	<b>WAARSCHUWINGEN</b> ..... FOUT! BLADWIJZER NIET GEDEFINIEERD.	
<b>7.</b>	<b>ONDERDELEN</b> .....	<b>8</b>
<b>8.</b>	<b>ACCESSOIRES</b> .....	<b>10</b>
<b>9.</b>	<b>VOORBEREIDINGEN</b> .....	<b>FOUT! BLADWIJZER NIET GEDEFINIEERD.</b>
<b>10.</b>	<b>INSTALLEREN</b> .....	<b>FOUT! BLADWIJZER NIET GEDEFINIEERD.</b>
<b>11.</b>	<b>GEBRUIKEN</b> .....	<b>FOUT! BLADWIJZER NIET GEDEFINIEERD.</b>
<b>12.</b>	<b>UITSCHAKELEN</b> .....	<b>15</b>
<b>13.</b>	<b>TROUBLESHOOTING</b> .....	<b>17</b>
<b>14.</b>	<b>TECHNISCHE SPECIFICATIES</b> .....	<b>17</b>
<b>15.</b>	<b>ONDERHOUD</b> .....	<b>17</b>
<b>16.</b>	<b>GARANTIE</b> .....	<b>17</b>

## 5. INTRODUCTION







### 5.1 DESCRIPTION AND APPLICATION OF THE CO2 POWER JET

The CO2 Power Jet is intended to electronically blow white smoke plumes of CO<sub>2</sub> from a distance. As soon as the CO<sub>2</sub> leaves the cylinder through the CO2 Power Jet's secured high-pressure hoses, it converts into gas. This formation of gas is accompanied by a strong hissing sound and a solid white plume of smoke will be visible. The length of this plume is on average 8 metres. This depends on the air humidity: in case of a high degree of air humidity, the smoke plume will be larger and in case of a low degree of air humidity it will be smaller.

The CO2 Power Jet must be connected to a carbon dioxide (CO<sub>2</sub>) bottle with dip pipe. The CO2 Power Jet is not suitable for other gases than those described above. Any use other than that described above will exclude your supplier from any liability.

### 5.2 NECESSARY ACCESSORIES

The following parts belong to the CO2 Power Jet:

		
<p><b>Manual</b></p>	<p><b>MFX0308 – Power cable</b></p>	<p><b>4 CO2 Bottles (with dip pipe)</b></p>
		
<p><b>High pressure hose 3/4</b></p>	<p><b>MFX1154 – Distribution block</b></p>	<p><b>High pressure hose 3/8</b></p>

Tafel 5.1

## **6. SAFETY**

### **6.1 INTRODUCTION**

The CO2 Power Jet has been designed and constructed in such a manner that it can be used safely. This applies to the use, the circumstances and the regulations as described in this documentation. Reading this documentation and following the instructions are therefore necessary for everyone who is authorised to work with the CO2 Power Jet.

The CO2 Power Jet must be placed and used in surroundings that preferably:

- Have a reasonably stable temperature of between 0 and 30°C.
- Have a relative humidity degree of no more than 75%.
- Are reasonably free of dust, corrosive gases and high concentrations of organic vapours.
- Are not situated in the vicinity of a source of vibration.

### **6.2 GENERAL SAFETY RULES**

- Only use the CO2 Power Jet if there are no people, animals or other objects in the direction of the output within the output distance. The shooting direction is the direction in which the output pipe on the CO2 Power Jet is pointed. The output distance depends on the humidity in the air.
- Make sure that children, unauthorised people and animals do not obtain access to the CO2 Power Jet!
- Safety devices may not be removed or disabled.
- All required safety devices must be in good condition and function properly.
- Ensure sufficient lighting of the surroundings.
- Keep the workplace clean.
- Only authorised persons may carry out work with the CO2 Power Jet.





### 6.3 WARNINGS

Warning texts have been attached to the CO2 Power Jet. With regard to these the following rules apply:

- These texts may not be removed or damaged. The operator must regularly check if this is the case.
- The operator must ensure that the texts are and remain clearly visible and legible.

	<p><b>DANGER WARNING:</b> One must replace texts or signs if these are absent, damaged or illegible.</p>
---	--

Sign and explanation	Photo
 <p>PIC 616 Follow the instructions</p>	
<p>The operator must be told that he/she may only operate the CO2 Power Jet after reading the user manual.</p> <p>A warning is given for this by means of the command sign of PIC 616. This sign should be attached to the type sign. See also the photo.</p>	

Sign and explanation	Photo
 <p>PIC 323 Low temperatures</p>	
<p>In case of low temperatures a low temperature warning must be issued by means of warning sign 323.</p> <p>This is attached to the top of the CO2 Power Jet.</p>	

## 7. ONDERDELEN

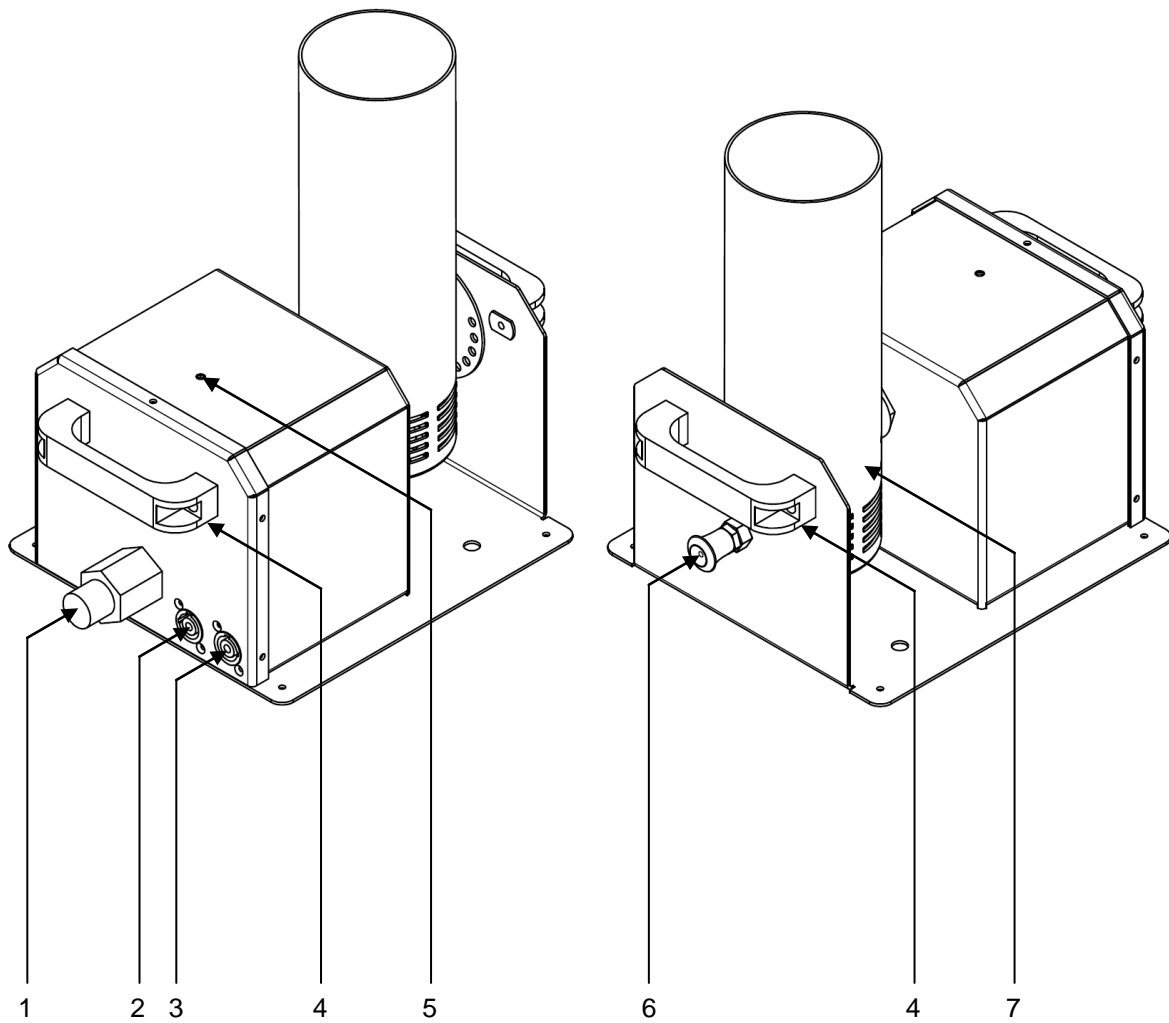

1. CO2 input
2. powerCON input
3. powerCON output
4. Handle
5. LED indicator
6. Lock pin
7. CO2 output

## 8. ACCESSOIRES

			
MFX0308 – Shuko – powerCON cable 1.5m	MFX1154 – Distribution block	MFX3104 – Quick trigger clamp M10	
			
MFX1151 – High pressure hose 3/4 - 6m	MFX1152 – High pressure hose 3/4 - 10m	MFX1153 – High pressure hose 3/4 - 15m	
			
MFX1103 – High pressure hose 3/8 - 3m	MFX1106 – High pressure hose 3/8 - 6m	MFX1110 – High pressure hose 3/8 - 10m	MFX1115 – High pressure hose 3/8 - 15m

Table 8.1

You can order these parts and accessories from:



MAGIC FX B.V.  
Schouwrooij 27  
NL-5281 RE BOXTEL  
The Netherlands  
T. +31(0)411 63 50 13  
F. +31(0)411 63 50 12  
W. <http://www.magicfx.eu>  
E. [info@magicfx.eu](mailto:info@magicfx.eu)



## 9. PREPARATIONS

Unpack the CO2 Power Jet. Dispose of the packaging material without harming the environment. Inspect the machine for any damage. If damage is noticed this must be reported to MAGIC FX.

## 10. INSTALLATION

	<p><b>CAUTION:</b> The machine can be damaged if you do not follow the procedures carefully.</p>
	<p><b>DANGER WARNING:</b> The MAGICFX® CO2 Power Jet may only be installed by adults and authorised persons.</p>
	<p><b>DANGER WARNING:</b> MAGIC FX is not liable for working with CO2 gas and CO2 bottles or for the correct use thereof.</p> <p>Exclusively use approved CO2 bottles (liquid carbon dioxide with dip pipe) and consult your gas supplier about the installation, instructions, guidelines and regulations for the safe use of the CO2 bottles.</p>

For installing the CO2 Power Jet work in the following manner:

1.



Place the CO2 Power Jet on a solid and even surface or mount it in a truss system using quick trigger clamps.



Always make sure that there are no people within 3 metres of the CO2 Power Jet.

2.



If required you can adjust the blow pipe to change the direction of the output.

Pull the lock pin backwards to unlock the pipe and adjust it to the required position.

3.



In order to test it, you first need to check if the gas valve on the CO2 bottle is still in a closed position. Now you can check if the CO2 Power Jet has been installed properly by switching the electricity on and off.

If the system has been connected properly you will hear a clicking sound which is produced by the opening and closing of the magnetic valve in the CO2 Power Jet.

4.



Now connect the 2m long high pressure CO2 hoses to the CO2 bottles.

Firmly secure the couplings by hand.



Turning it by hand will suffice! You should only use a wrench if the coupling continues to leak.

5.



Place the CO2 bottles (liquid CO2 with dip pipe) on an even and solid surface. Place the bottles in such a position that the valve opening does not point in the direction of persons or objects. Place the CO2 bottles preferably outdoors or in a properly ventilated space with a CO2 detection system. CO2 bottles are pressure containers. That is why you must secure them with special gas bottle brackets or chains to prevent them falling over.

6.



Connect the other ends of the CO2 high pressure hoses to the distribution block and check that these are properly connected.

7.

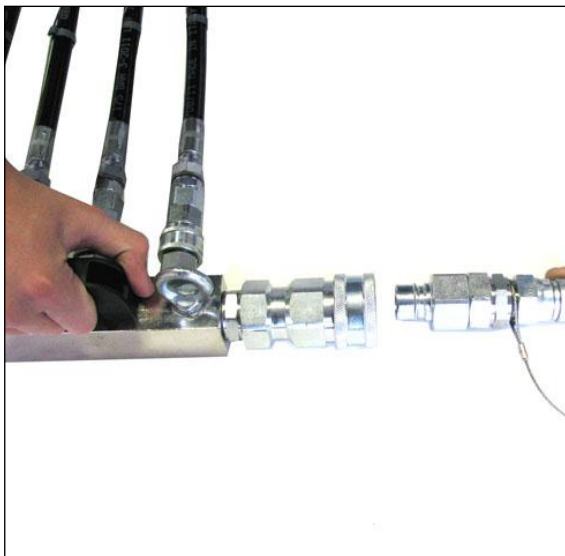

Now connect the 3/4" CO2 high pressure hose to the distribution block and check if it is firmly connected.

8.



Connect the hose to the CO2 Power Jet and let it click into place so it is firmly secure.

**9.**

The CO2 Power Jet is activated as soon as it is powered by a 230V electricity source. Use a 230V plug and make sure that the electricity is switched off! Plug the CO2 Power Jet into the electricity socket.



**10.**

When the system is properly connected you can open the valve of the CO2 bottle. Check for leaks. When the gas hoses are not properly connected gas can escape. If this is the case then turn the couplings tighter until gas is no longer escaping.

The CO2 Power Jet is now ready for use.



## 11. USAGE

	<p><b>TIP:</b> Gives you suggestions and advice regarding easier or more convenient ways to carry out certain tasks.</p>
	<p><b>CAUTION:</b> The machine can be damaged, if you do not follow these procedures carefully.</p>
	<p><b>DANGER WARNING:</b> The MAGICFX® CO2 Power Jet may only be installed by adults and authorised persons.</p> <p>The CO2 Power Jet may only be operated if all parts are completely and correctly installed/connected.</p>

For using the CO2 Power Jet take the following steps:

1.

	<p>To operate the CO2 Power Jet you press the switch on and off. As soon as you press the switch the magnetic valve will immediately open and a white smoke plume will exit from the CO2 Power Jet. When you press the switch again to the off position the valve will immediately close.</p> <p>Never switch for more than 3 seconds. This way you prevent dry ice from forming on the blow pipe and you will not cause an accumulation of CO2 in the room.</p>
--	--



	<p>The CO2 Power Jet can be operated by means of DMX. To this end use a DMX FX Switchpack.</p>
	<p> Ensure that you always have the CO2 Power Jet in clear sight.</p>



## 12. SWITCHING OFF

To switch off the CO2 Power Jet, take the following steps:

1.



Close the valves of the gas bottle.

2.



Activate the CO2 Power Jet one more time to remove the remaining pressure from the hose.



Make sure that you only activate the jet when there are no people, animals or objects in the trajectory of the cannon.

3.



Disconnect the plug(s) of the CO2 Power Jet from the power supply.

4.

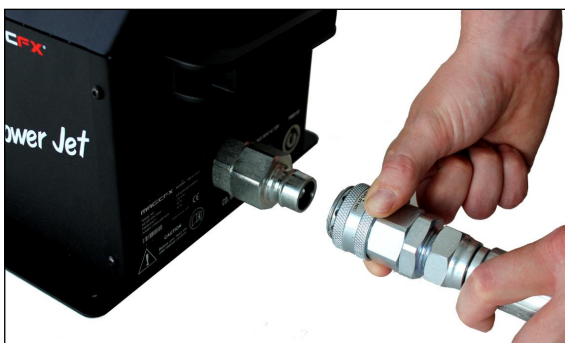

Only when there is no more gas in the hose can the hose be disconnected from the gas bottle and the CO2 Power Jet.

## 13. TROUBLESHOOTING

### - The CO2 Power Jet is leaking

Check if the coupling of the gas hose is connected properly to the coupling of the CO2 Power Jet. If it is not entirely secured then press it firmly. This is only possible when there is no pressure on the hose. If the problem persists, then consult the technical service of MAGIC FX.

### - Only a small smoke plume is visible when the CO2 gas exits the CO2 Power Jet.

Visibility can vary due to air humidity. The output will be more visible when there is high absolute air humidity.

### - There is no white smoke plume visible when the CO2 gas exits the CO2 Power Jet.

You may not have the right carbon dioxide cylinders. Connect cylinders with liquid carbon dioxide and a dip pipe to the CO2 Power Jet.

In some cases the dip pipe may be broken. In that case replace the carbon dioxide cylinder with another and inform your gas supplier about the cylinder with the defective dip pipe.

### - The CO2 Power Jet is still malfunctioning after troubleshooting

Always contact your dealer or the technical service of MAGIC FX first in case of uncertainties, questions about the CO2 Power Jet works or other issues with regard to the CO2 Power Jet.

## 14. TECHNISCHE SPECIFICATIES

Afmetingen en gewicht	Lengte:	270mm (10.6")
	Breedte:	260mm (10.2")
	Hoogte:	350mm (13.8")
	Gewicht:	7,5 Kg (16,5lbs.)
Power	Input:	AC 230V~50-60Hz
	Output:	AC 230V~50-60Hz
	Verbruik:	100W
CO <sub>2</sub>	Input:	Vloeibare CO <sub>2</sub>
	Output:	CO <sub>2</sub> Gas
	Verbruik:	2 Kg/s (1.1 lbs/s)
	Quick Connector:	RU 1 (W21,8x1/14") – 3/8" BSP

Ontwerp en product specificaties kunnen worden gewijzigd zonder voorafgaande kennisgeving.

## 15. ONDERHOUD

Om de maximale levensduur van de CO2 Power Jet te bereiken dient u uw CO2 Power Jet regelmatig schoon te maken en testen op de correcte werking van de CO2 Power Jet.

Mocht de CO2 Power Jet om wat voor reden niet werken neem dan contact op met MAGIC FX.

	<p><b>WAARSCHUWING VOOR GEVAAR:</b>  <b>Vervang onderdelen niet zelf maar raadpleeg altijd MAGIC FX indien nodig.</b></p>
---	---

## 16. GARANTIE

Voor de MAGIC FX CO2 Power Jet geldt een fabrieksgarantie van 3 jaar.

- De garantie vervalt als de CO2 Power Jet voor oneigenlijke doeleinden is gebruikt en voor toepassingen die niet in de handleiding vermeld zijn.
- De garantie vervalt eveneens als het apparaat verkeerd of in strijd met de voorschriften is gebruikt.
- De garantie vervalt als de machine zonder toestemming van de leverancier gewijzigd wordt.