

# **USER MANUAL**

**I MIX**

**06/08/10/12CH**

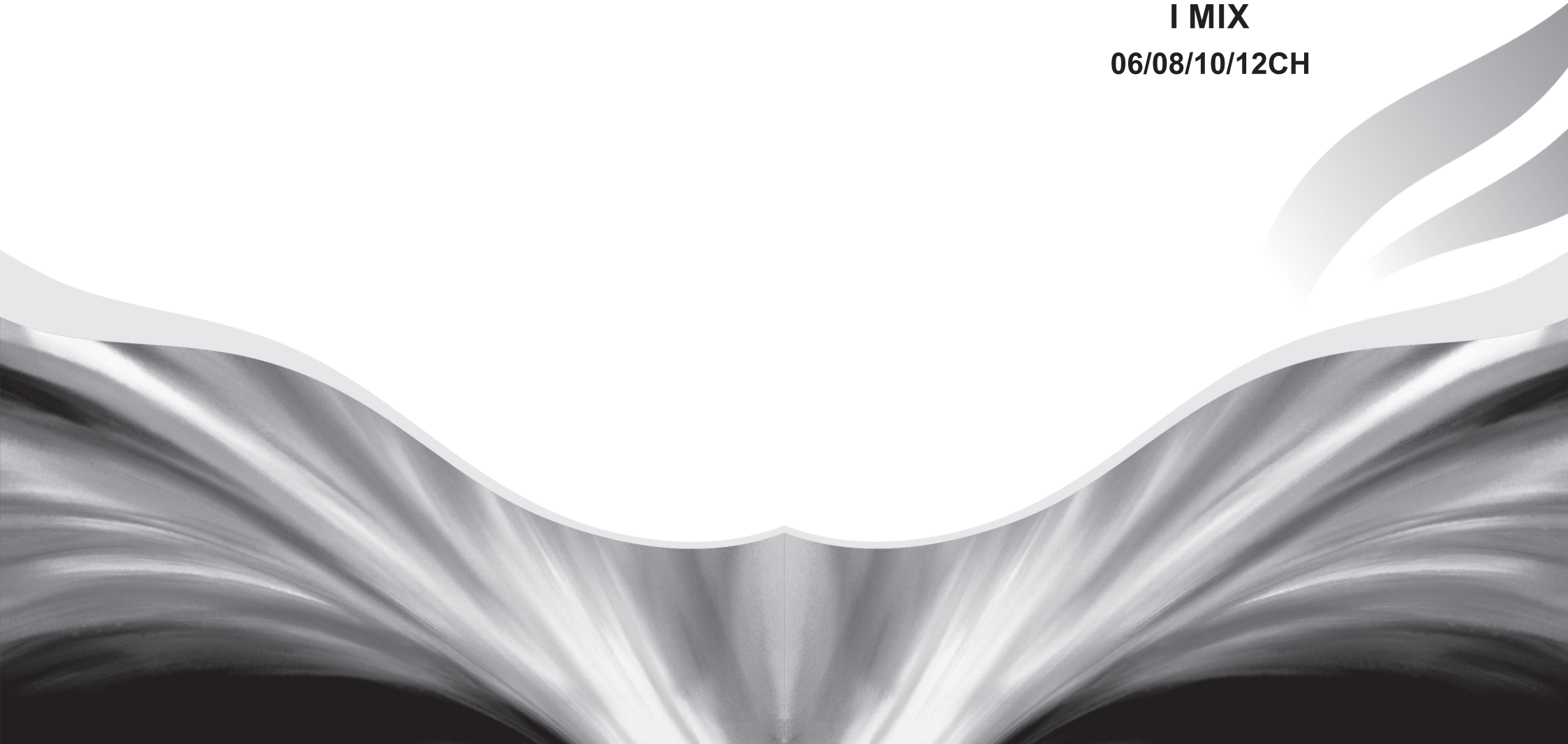

## IMPORTANT SAFETY SYMBOLS



Use only with the cart, stand, tripod, bracket, or table specified by the manufacturer, or sold with the apparatus. When a cart is used, use caution when moving the cart/apparatus combination to avoid injury from tip-over.



The symbol is used to indicate that some hazardous live terminals are involved within this apparatus, even under the normal operating conditions, which may be sufficient to constitute the risk of electric shock or death.



The symbol is used in the service documentation to indicate that specific component shall be replaced only by the component specified in that documentation for safety reasons.



Protective grounding terminal



Alternating current/voltage

**ON:** Denotes the apparatus is turned on



Hazardous live terminal

**OFF:** Denotes the apparatus is turned off.

**WARNING:** Describes precautions that should be observed to prevent the danger of injury or death to the operator.

**CAUTION:** Describes precautions that should be observed to prevent danger of the apparatus.

## 1. IMPORTANT SAFETY INSTRUCTIONS

- **Read these instructions.**
- **Keep these instructions.**
- **Heed all warning.**
- **Follow all instructions.**

### • **Water & Moisture**

The apparatus should be protected from moisture and rain, can not used near water, for example: near bathtub, kitchen sink or a swimming pool, etc.

### • **Heat**

The apparatus should be located away from the heat source such as radiators, stoves or other appliances that produce heat.

### • **Ventilation**

Do not block areas of ventilation opening. Failure to do could result in fire. Always install accordance with the manufacturer's instructions.

### • **Object and Liquid Entry**

Objects do not fall into and liquids are not spilled into the inside of the apparatus for safety.

### • **Power Cord and Plug**

Protect the power cord from being walked on or pinched particularly at plugs, convenience receptacles, and the point where they exit from the apparatus.

Do not defeat the safety purpose of the polarized or grounding-type plug. A polarized plug has two blades with one wider than the other. A grounding type plug has two blades and a third grounding prong. The wide blade or the third prong is provided for your safety. If the provided plug does not fit into your outlet, refer

to electrician for replacement.

### • **Power Supply**

The apparatus should be connected to the power supply only of the type as marked on the apparatus or described in the manual. Failure to do could result in damage to the product and possibly the user.

Unplug this apparatus during lightning storms or when unused for long periods of time.

Where the MAINS plug or an appliance coupler is used as the disconnect device, the disconnect device shall remain readily operable.

### • **Fuse**

To prevent the risk of fire and damaging the unit, please use only of the recommended fuse type as described in the manual. Before replacing the fuse, make sure the unit turned off and disconnected from the AC outlet.

### • **Electrical Connection**

Improper electrical wiring may invalidate the product warranty.

### • **Cleaning**

Clean only with a dry cloth. Do not use any solvents such as benzol or alcohol.

### • **Servicing**

Do not implement any servicing other than those means described in the manual. Refer all servicing to qualified service personnel only.

• Only use accessories/attachments or parts recommended by the manufacturer.

## 1. Introduction:

Thank you for purchasing this series compact mixer which features universal voltage 100-240V, compression function of each mic channel to keep crystal clear sound during performance. The mixer can play the music via SD card/USB/bluetooth. The mic sound or music of line in can be recorded to SD card/USB to suit for the requirement of solo or band performance or conference recording. This series can also be connected with PC for playback and recording.

## Application:

suitable for the applications in PA system or indoor recording, e.g. Movie/TV/music recording in theatre/dancing hall/bar/conference hall, etc;

## 2. Function

- 1) 1-8 CH MIC/line and 2CH stereo inputs;
- 2) Compression function of mic channels (0-9dB);
- 3) Built-in USB/SD card/bluetooth playing/recording function;
- 4) 48V phantom power for condenser mic;
- 5) Built-in 16 program DSP with adjustable delay for wonderful effect;
- 6) Main outputs with 2X8 accurate meter to monitor output level;
- 7) Universal voltage 100V-240V;
- 8) MP3 interface can connect with PC for playback and recording;

## Specification

Mono input	
Mic input	Bal input
Frequency response	10 Hz to 30 kHz, +/-3 dB
THD(THD&N)	0.03% at +4 dBu, 22Hz-20kHz A-weighted
Compression	GAIN:0-9dB, THRESHOLD: 20dB <sup>↓</sup> 5dB
S/N ratio	(SNR)115 dB
Line in	Bal input
Frequency response	10 Hz to 30kHz, +/-3 dB
THD(THD&N)	0.005% at+4 dBu, 22Hz-20kHz A-weighted
Max gain	75 dBu MIC INPUT MAIN OUTPUT
Stereo input channel	
Line in	Bal/unbal
Frequency response	10 Hz to 55 kHz, +/-3 dB
THD(THD&N)	0.005% at +4 dBu, 22Hz-20kHz A-weighted
Impedance	
Mic input	1.4 kOhm
Line in	10 kOhm
Other inputs	10 kOhm or more
Recording output	1 kOhm
Other outputs	120 Ohm
Mono EQ	
HI	+/-15 dB @12 kHz
MID	+/-15 dB @2.5 kHz
LOW	+/-15 dB @45 Hz
Low cut filter	80 Hz, 18 dB/Oct.
Stereo EQ	
HI	+/-15 dB @12 kHz
LOW	+/-15 dB @60 Hz
DSP	A/D & D/A converter sample frequency 24-Bit, 16 programs
Main mix	
Noise (BUS noise)	Fader 0dB, all input channel knobs set to minimum, EQ knobs set to middle, :-100dBu(reference:+4dBu)
Max output	Bal: +27dBu; unbal: +22dBu 1/4" connector
	AUX: +22 dBu
	DSP: +22dBu
Power supply	100-240 VAC~50/60 Hz
Dimension(D*W*H)mm	06CH:330X224X92 08CH:330X280X92 10CH:330X336X92 12CH:330X392X92
Net weight	06CH: 3.5KG 08CH: 4KG 10CH: 4.5KG 12CH: 5.2KG

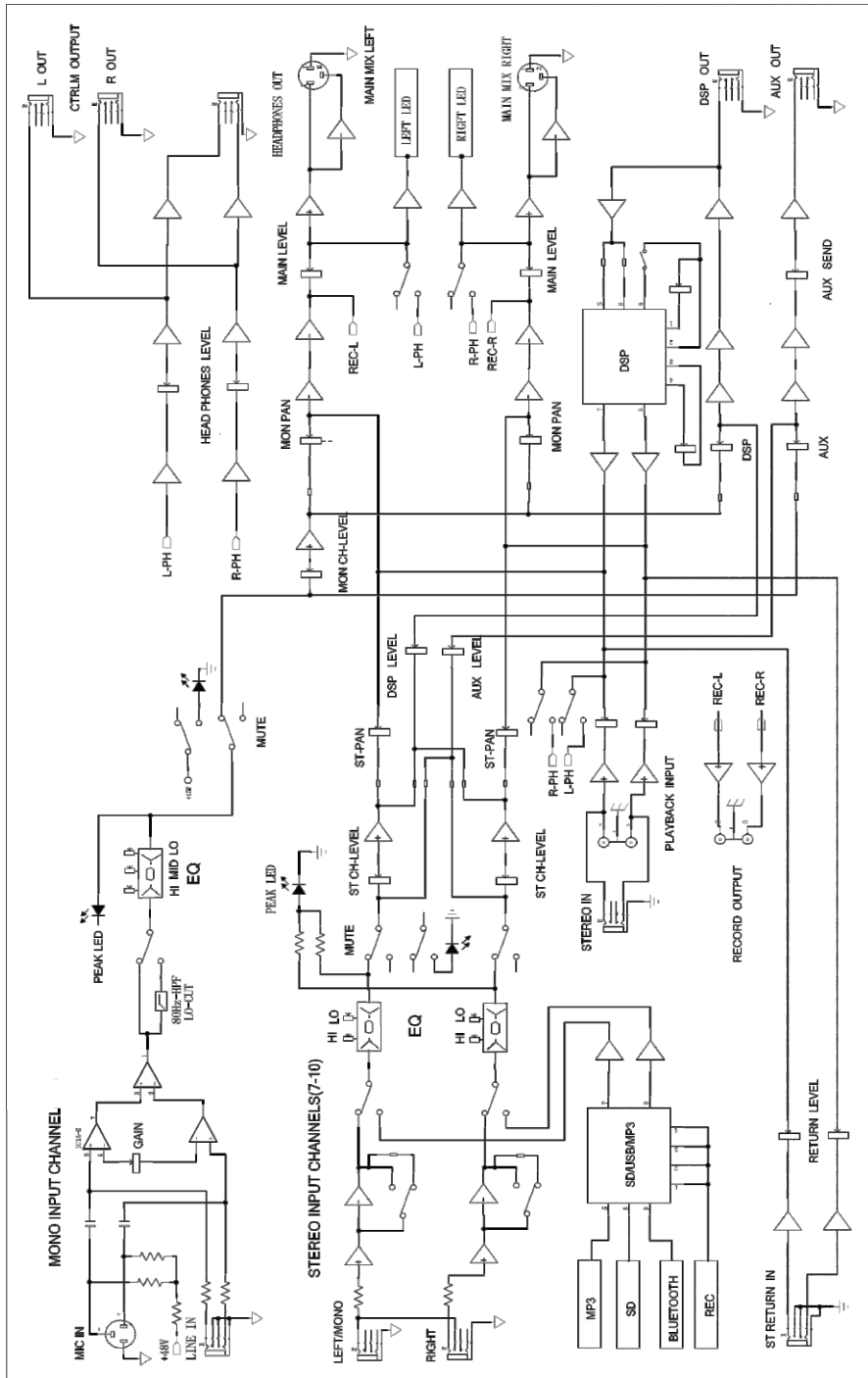

A. Channel

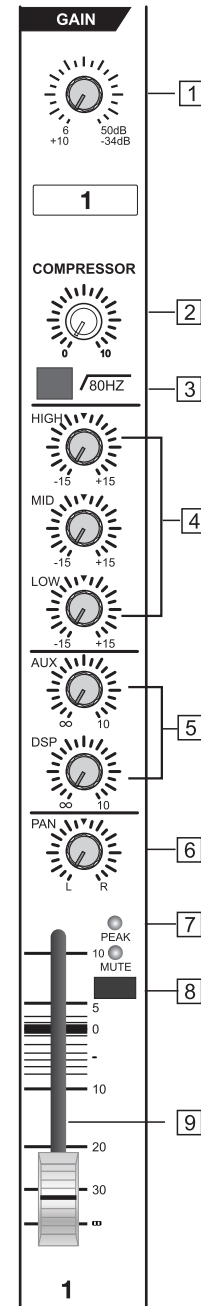

1. Gain control

It adjusts input signal level to balance the S/N ratio and dynamic range. To get best effect, adjust this knob: make PEAK LED flashes sometimes to avoid channel distortion.

**Mic input gain range:** 6~50dB, line in gainrange: +10~-34.

2. COMP:

It adjusts channel compression. Turn clockwise to increase compression ratio and gain will adjust automatically.

3. HPF

It turns on/off the HPF with 18 dB octave to activate 80 Hz LF filter. You can also use it to reduce mains hum noise or stage mic noise.

4. EQ control

Hi: when you set it to max, 12KHz frequency level boosts +15dB. To min, and the 12KHz frequency levelcuts -15dB.

MID: when you set it to max, 2.5KHz frequency level boosts +15dB. To min, and the 2.5KHz frequency level cuts -15dB.

LOW: when you set it to max, 45Hz frequency level boosts +15dB. To min, and the 45Hz frequency level cuts -15dB

5. AUX-DSP

These two knobs are used to the level of signal sent to AUX-DSP BUS, and then to external DSP, or to built-in DSP module. DSP knob can also adjust channel level.

6. PAN

Set it to middle position, then sound image will be in the middle of the stage. It can also adjust the left/right output signal.

7. PEAK LED

When signal reaches the level of clipping level deducted 3dB, PEAK LED lights up red.

8. MUTE & LED

Each channel is designed with MUTE button. Press it to mute the channel. The mute LED lights up.

9. FADER

It adjusts the level of channel signal which is sent to main mix out. Note: set the unused faders to minimum position.

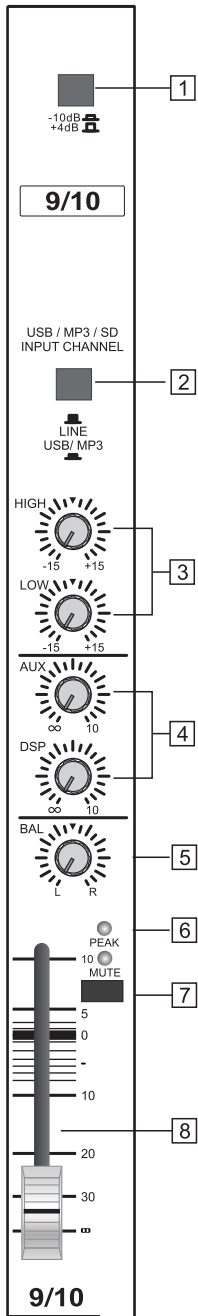

## Stereo channel

### 1. -10/+4 sensitivity switch

Press this switch, this sensitivity will be 10dB higher.

### 2. LINE/USB/MP3 selection switch

Release for stereo line input. Press for USB/MP3/bluetooth input.

### 3. EQ control

**Hi:** set to maximum position, and 12KHz frequency level boosts +15dB. Set to minimum position, and 12KHz frequency level cuts -15dB.

**Low:** set to maximum position, and 60Hz frequency level boosts +15dB. Set to minimum position, and 60Hz frequency level cuts -15dB.

### 4. AUX-DSP

These two knobs are used to the level of signal sent to AUX-DSP BUS, and then to external DSP, or to built-in DSP module. DSP knob can also adjust channel level.

### 5. PAN

Set it to middle position, then sound image will be in the middle of the stage. It can also adjust the left/right output signal.

### 6. PEAK LED

When signal reaches the level of clipping level deducted 3dB, PEAK LED lights up red.

### 7. MUTE BUTTON & MUTE LED

Each channel is designed with MUTE button. Press it to mute the channel. The mute LED lights up.

### 8. FADER

It adjusts the channel level.

Note: set the faders of unused channels to minimum position to reduce noise.

## Bal/unbal mode of TRS/XLR connectors

1/4 "TRS or XLR connector bal/unbal modes; please refer to below:

1/4 " connector

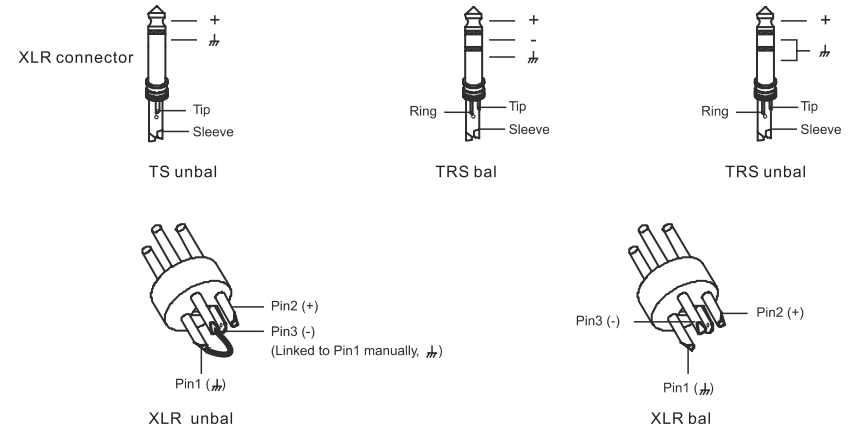

## Connection

The supplied 1/4 "TRS and XLR connector to connect with pro audio equipments; please refer to below:

### Balanced

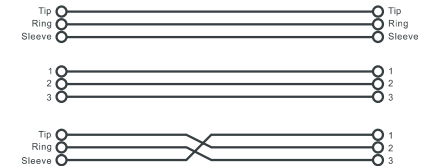
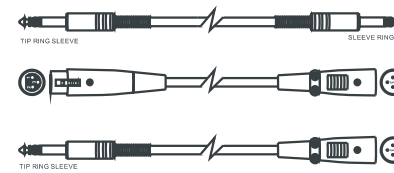

### Unbalanced

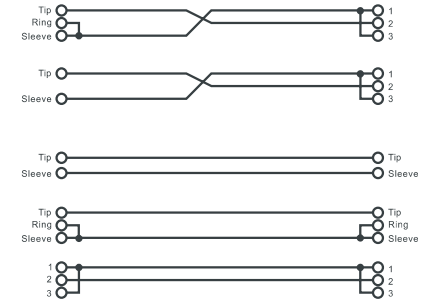
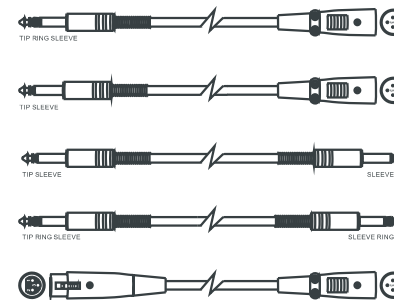

Selecting and playing individual tracks from an USB or SD card.

Press and hold the PLAY/PAUSE button.

Use the forward/back buttons to select the required track.

Release the PLAY/PAUSE button.

Your selected track will now be cue'd and paused and will play when the PLAY/PAUSE button is pressed again.

Useful tips for getting most out of your playback facility during a live performance :

Record a track with no sound on it, say 30 seconds long. Call this track '001 - Silence' and make sure it's always the first track in your file. The reason to do this, is to allow you sufficient time when inserting your memory stick to allow you to enter the play/pause track cueing facility without accidentally playing a track. You can then select the track want leaving the player in PAUSE ready for the performance.

Add a few seconds (up to about 30 seconds) of no sound (quiet) to the end of all of your recorded tracks.

The player will automatically play the next track in sequence if you have multiple tracks, so adding this quiet section to your tracks allows you time to stop your player and cue your next track, to avoid the player going into an unwanted track

## Installation

1. There should be no obstacles before the speaker cabinet. You had better put the speaker cabinet on a speaker stand.
2. Use professional devices to suspend or install the speaker cabinets to avoid hurt.
3. Use high quality cable to ensure the best tone.
4. Please match the right power and impedance of power amplifier and speaker cabinet.
5. Do not point the microphone to the speaker cabinet to avoid feedback.

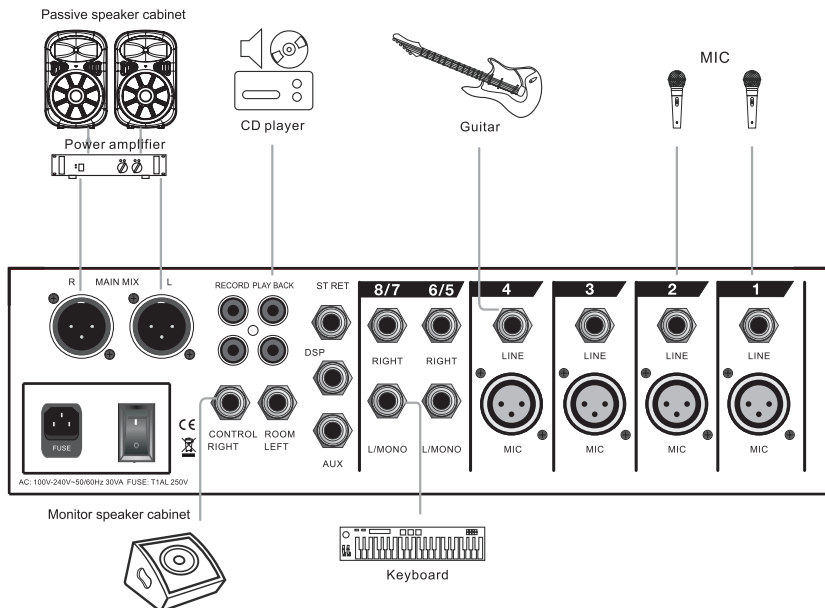

## OUTPUT AND REAR PANEL

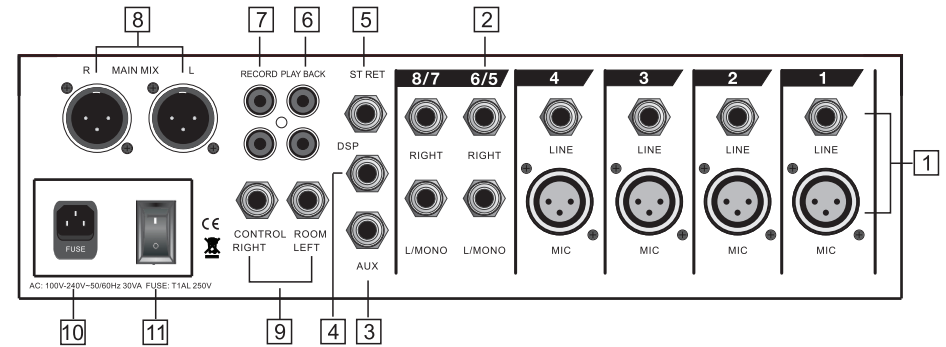

### 1. MIC/LINE CHANNEL (CH1-6)

Balanced XLR input connector (1: ground; 2: hot; 3: cold).KG08 Is designed with 4 low noise mic pre-amp (06CH has 2, 10CH has 6, 12CH has 8) and phantom power, 45dB gain and >100 dB S/N ratio. The phantom power is used for condenser mic. If you use dynamic mic, please turn off phantom power first. These channels are designed with 1/4inch TRS bal/unbal line in connectors to connect with keyboard, electric drum, DSP, etc.

### 2. Stereo channel input

Unbalanced connectors. If signal input from LEFT/MONO, the signal outputs from L/R main mix outputs. If signal inputs from RIGHT connector, signal outputs from R main mix output. This connector can be connected with keyboard, electric drum, DSP, etc.

### 3. AUX SENDS

1/4" phone jacks to send signal from AUX BUS to external equipments, e.g. Effect equipment or stage monitor, etc;

### 4. DSP output

1/4" phone jack to output DSP signal and the level is controlled by channel DSP.

### 5. AUX RETURNS input

Stereo 1/4" phone jacks to return effect equipment stereo signal to Main Mix. Or you can Use AUX RETURN knob to adjust volume. The input AUX signal will be sent to MAIN MIX.

### 6. PLAYBACK

Unbal RCA and 3.5 connectors to input signal from CD player/computer, etc;

### 7. RECORD

Unbal RCA connector to output signal to recording equipment.

### 8. MAIN MIX output

Bal XLR connector. The level is adjusted by Main Mix fader.

### 9. CTRL ROOM output

1/4" phone jacks send Control Room signal to monitor speaker cabinet.

### 10. POWER socket

It is designed with fuse to connect with mains. Please replace the fuse with the same type and rating.

### 11. POWER switch

It turns on/off the mixer.



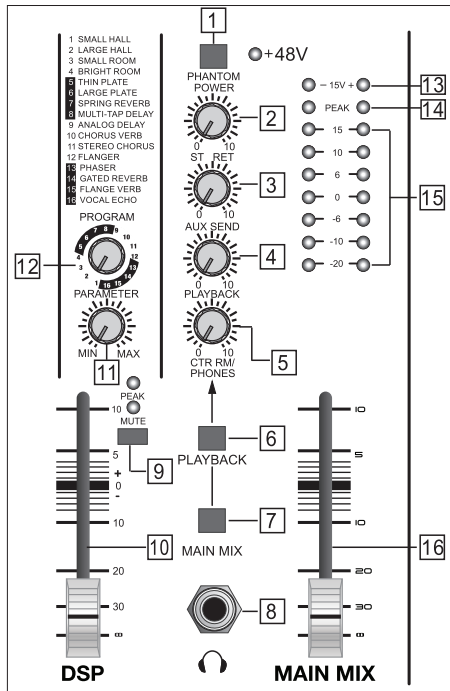

- 1. +48V phantom power switch/red when on**  
It is used for condenser mic operation. Please set all faders to minimum before turning on the switch to protect speaker cabinets.
- 2. Stereo return**  
It adjusts stereo return signal level.
- 3. AUX send**  
It adjusts aux send level.
- 4. PLAYBACK**  
It adjusts the playback signal level.
- 5. CTRLMP PHONES**  
It adjusts the phone signal level.
- 6. PLAYBACK switch**  
Press the switch to send signal to monitor and phones.
- 7. MAIN MIX switch**  
Press the switch to send MAIN signal to monitor and phones.
- 8. Phone output**  
This connector send signal to phones.
- 9. DSP ON switch**  
Press this switch to start DSP operation and LED lights up green.
- 10. DSP fader**  
It adjusts the DSP signal level.

**11. PARAMETER**  
It adjusts the delay time.

**12. PROGRAM**

Prg#	Description	Parameter 1
1	Small Hall	Rev Time 0.9sec~3.5sec
2	Large Hall	Rev Time 1.5sec~8.6sec
3	Small Room	Rev Time 0.28sec~0.82sec
4	Bright Room	Rev Time 0.36sec~1.38sec
5	Thin Plate	Rev Time 0.44sec~1.54sec
6	Large Plate	Rev Time 0.72sec~10sec
7	Spring Reverb	Rev Time 0.4sec~2.3sec
8	Multi-tap Delay	Delay Time 0~680ms
9	Analog Delay	Delay Time 0~680ms
10	Chorus Verb	Rev Time 0.56sec~3.5sec
11	STEREO CHORUS	Rate 0.58Hz~6Hz
12	Flanger	Rate 0.58Hz~4.35Hz
13	Phaser	Rate 0.58Hz~11Hz
14	Gated Reverb	Gate Time 0.25sec~0.78sec
15	Flange Verb	Rev Time 0.34sec~2sec
16	Vocal Echo	Delay Time 0~400ms

**13. POWER LED**

**14. PEAK LED**

**15. MAIN OUTPUT LEVEL LED**

**16. MAIN MIX fader**

It adjusts the MAIN MIX output level.

**SD/USB/BLUETOOTH**

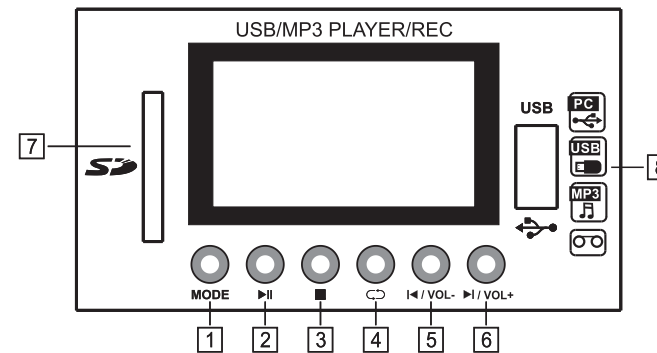

**1. MODE**

Press this button to select mode: SD card, USB, bluetooth, recording.

a) SD/USB mode: insert SD card/USB to play music directly.

b) Bluetooth mode: press the button to select bluetooth, then match the bluetooth, then play music.

c) Recording mode: press the button to select recording mode. Input signal from mic or line, then press play button to record.

The LCD displays recording symbol flashing.

**2. Play/pause button**

**3. Stop button**

**4. Repeat button**

**5. Previous button**

**6. Next button**

**7. Sd card connector for playback and recording**

**8. USB interface to connect with PC for playback and recording**

SD card/USB details

Loop Functions

1 = play one chosen track on loop (repeat) Note in this mode individual tracks cannot be selected.

F = play all tracks within same folder on your SD card or USB drive in sequence on loop (repeat).

R = shuffle - plays all tracks randomly no loop (no repeat)

A = plays all tracks in sequence on loop (repeat)