

INSTALLATION GUIDE / USER MANUAL

M804DSP

Technical and Safety Notices

Please read the following important technical, safety and environmental notices before installing and using your amplifier.

Technical Notices

All reasonable design and engineering steps have been taken to ensure that these amplifiers always perform satisfactorily in their intended application and environment and will provide appropriate levels of support to ensure that all reasonable customer needs and expectations are met. Such support however is contingent on the following provisions.

1. These amplifiers are Class-I products and should be installed with a mains cable including the required earth connection to comply with the Safety Class-I.
2. These amplifiers should always be installed by competent and qualified personnel. Amplifier damage or failure caused by installation or operational errors may invalidate support, warranty or guarantees of performance.
3. These amplifiers are not suitable for use in locations where they may be accessible to minors.
4. These amplifiers are intended to be used specifically for the amplification of audio signals and for connection to moving-coil loudspeaker systems. Use of these amplifiers for amplification of signals outside the audio band (20Hz to 20kHz) or to drive transducers other than moving-coil loudspeakers may invalidate support, warranty or guarantees of performance.
5. These amplifiers should only be used within professionally installed and configured audio systems comprising input and output ancillary equipments that is known to be of an appropriate level of performance and in good operating condition. Any damage to, or unsatisfactory performance from, these amplifiers caused by inadequate or failed input or output ancillaries may invalidate support, warranty or guarantees of performance.
6. These amplifiers are intended to be installed and operated indoor in a controlled environment (pollution degree, PD2) within an ambient temperature range of 0°C to 40°C. These amplifiers are not intended for use above 2000 meters above sea level. Amplifiers installed or operated in environments outside these limits may invalidate support, warranty or guarantees of performance.
7. Specific warranty terms are the responsibility of the amplifier re-seller.

Safety and Environmental Notices

Note: The intent of the lightning flash with arrowhead symbol in a triangle is to alert the user to the presence of uninsulated "dangerous" voltage within the product's enclosure that may be of sufficient magnitude to constitute a risk of electric shock to humans.

Note: The intent of the exclamation point within an equilateral triangle is to alert the user to the presence of important safety, and operating and maintenance instructions in this manual.

WARNING! TO PREVENT FIRE OR ELECTRIC SHOCK, DO NOT EXPOSE THIS EQUIPMENT TO RAIN OR MOISTURE.

Ambient Temperature Note: If this equipment is operated in a confined or multiple rack installation, the internal ambient operating temperature may exceed the external ambient temperature. It is important to ensure in these circumstances that the published maximum operating temperature for the equipment is not exceeded.



Reduced Air Flow: Ensure that rack or other closed installation does not restrict the cooling airflow required for safe and reliable operation of the equipment.

Technical and Safety Notices

Important Safety Instructions

1. Read these instructions.
2. Keep these instructions.
3. Heed all warnings.
4. Follow all instructions.
5. Do not use this apparatus near water.
6. Do not submerge the equipment in water or liquids.
7. Do not use any aerosol spray, cleaner, disinfectant or fumigant on, near or into the equipment.
8. Clean only with a dry cloth.
9. Do not block any ventilation opening. Install in accordance with the manufacturer's instructions.
10. Do not install near any heat sources such as radiators, heat registers, stoves, or other apparatus (including amplifiers) that produce heat.
11. To reduce the risk of electrical shock, the power cord shall be connected to a mains socket outlet with a protective earthing connection.
12. Do not defeat the safety purpose of the polarized or grounding type plug. A polarized plug has two blades with one wider than the other. A grounding type plug has two blades and a third grounding prong. The wide blade or the third prong are provided for your safety. If the provided plug does not fit into your outlet, consult an electrician for replacement of the obsolete outlet.
13. Protect the power cord from being walked on or pinched particularly at plugs, convenience receptacles, and the point where they exit from the apparatus.
14. Do not unplug the unit by pulling on the cord, use the plug.
15. Only use attachments/accessories specified by the manufacturer.
16. Unplug this apparatus during lightning storms or when unused for long periods of time.
17. Refer all servicing to qualified service personnel. Servicing is required when the apparatus has been damaged in any way, such as power supply cord or plug is damaged, liquid has been spilled or objects have fallen into the apparatus, the apparatus has been exposed to rain or moisture, does not operate normally, or has been dropped.
18. The appliance coupler, or the AC Mains plug, is the AC mains disconnect device and shall remain readily accessible after installation.
19. Adhere to all applicable, local codes.
20. Consult a licensed, professional engineer when any doubt or questions arise regarding a physical equipment installation.

Environmental Statement



This product complies with international directives, including but not limited to the Restriction of Hazardous Substances (RoHS) in electrical and electronic equipment, the Registration, Evaluation, Authorization and restriction of Chemicals (REACH) and the disposal of Waste Electrical and Electronic Equipment (WEEE). Consult your local waste disposal authority for guidance on how properly to recycle or dispose of this product.

Introduction and Overview

1. Introduction

M804DSP power amplifiers have been designed to provide configurable, consistent and reliable high performance audio power amplification for residential, commercial and entertainment applications.

This manual covers the features, installation and functions of the M804DSP IP500.2, IP800.2, IP500.4 and IP800.4 models. Please read the manual fully before installing and using an amplifier. If you have any questions regarding amplifier configuration, installation or operation please contact the appropriate customer support portal.

Following this introduction, the manual is divided into sections covering the following topics:

- 2. Overview
- 3. Carton Contents
- 4. Installation
- 5. Configuration
- 6. Connections
- 7. Operation
- 8. Specifications

2. Amplifier Overview

M804DSP amplifiers are a full rack width, 2U format power amplifiers that can drive both conventional low impedance (Lo-Z, 4Ω to 16Ω) loudspeakers and high impedance (Hi-Z, 70V/100V) transformer coupled loudspeakers. They provide four analog inputs, one stereo S/PDIF digital input, and either two or four outputs (Lo-Z mode), or one or two outputs (Hi-Z or Lo-Z BTL mode). M804DSP amplifier model output channel counts and power outputs are as follows:

M804DSP

Mode	Channels	Max Rated Output per Channel
Lo-Z	Four	750 Watts
Lo-Z (BTL)	Two	1500 Watts
Hi-Z	Two	1500 Watts

Note: In Lo-Z BTL (bridge-tied load) mode, two amplifier output channels are combined to create a single, double power output channel. BTL mode can be engaged via the amplifier Output Mode configuration setup menu described in Section 5 of this manual.

2.1 Connections and Power Switching

M804DSP signal input and output connections are accomplished via RCA Phono and Euroblock style connectors. A GPIO (General Purpose In/Out) Euroblock connector enables some amplifier functions to be controlled externally, and wireless or RJ45 socket Ethernet network connection options are also provided. Cable connectors and connections are described and illustrated in Section 6 of this manual

M804DSP amplifiers incorporate a front panel mounted power button. Press the button once to switch the amplifier on or off. Amplifier power management behaviour can be configured via the Control web app **Settings Menu** described in Section 5 of this manual.

Introduction and Overview

2.2 Network Features

M804DSP amplifiers are TCP/IP network connected devices that require a wired or wireless network connection to access their configuration menus. The configuration menus are accessed via the Control Web App interface and cover Input, Zone, Output and General Settings functions. The Control web app configuration menus are described in **Section 5** of this manual.

2.3 Firmware

This manual describes the features, functions and user interface of M804DSP amplifiers running **Firmware Version 1.4.0**.

It is strongly recommended that the firmware version installed in the amplifier in use is checked initially, and regularly thereafter. If updated firmware is available, the amplifier should be updated as a priority.

The firmware installed in the amplifier can be identified and updated by selecting the **Device** option in the Control web app **Settings Menu**. Firmware versions can be checked, and firmware downloaded, from the website:

<https://www.nextaudiogroup.com/en/product/m804-dsp>

3. Carton Contents

M804DSP amplifiers are shipped in a cardboard carton containing the amplifier unit, a mains cable appropriate for the sales territory, an accessory pack, and a document pack. The full contents is listed below.



- Amplifier unit
- Rack mount ears (fitted)
- Mains power cable
- Input connector x 2
- GPIO socket connector
- Output connector x 1 or 2
- Adhesive rubber feet x 4
- Document pack

Installation

4. Installation

4.1 Amplifier Location

M804DSP amplifiers are shipped with rack "ears" attached and are primarily intended for standard (19 inch) equipment rack installation. If not to be installed in an equipment rack, M804DSP amplifiers can be placed free-standing on a flat surface. Adhesive rubber feet are supplied for this purpose.

It is important that any installation provides space for airflow through the ventilation apertures at the front and rear of the amplifier. This is illustrated in Diagram 4A.

Diagram 4A

M804DSP amplifier dimensions.

(Shaded area defines ventilation space.)

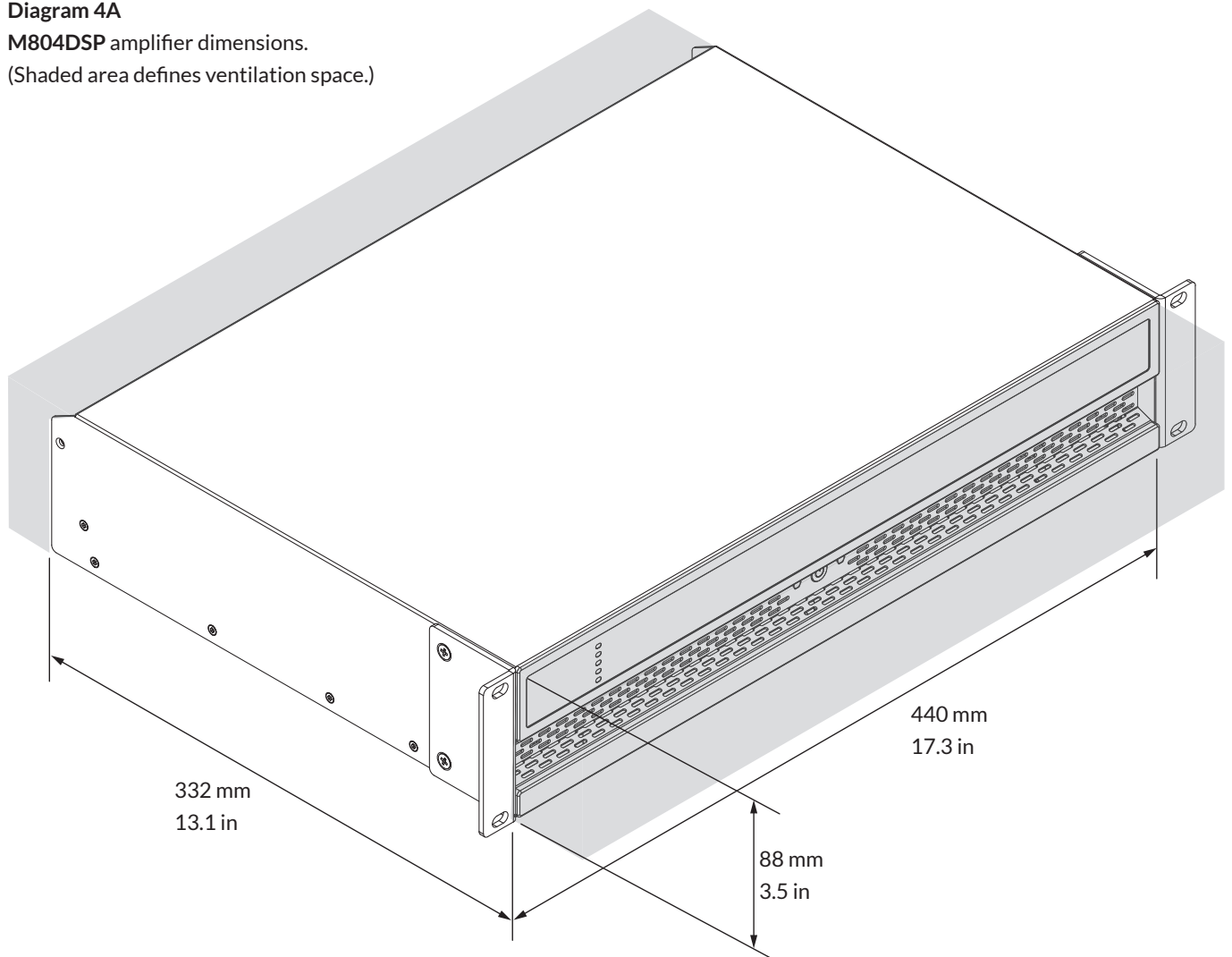

Configuration

5. Configuration

Before making input, output and GPIO connections, an initial M804DSP amplifier configuration should be established. It is particularly important that the amplifier output format is configured appropriately for the speakers that are to be connected.

Configuration requires that M804DSP amplifiers are connected to mains power, switched on and connected to network services. These connections are described in the following two sections.

5.1 Mains Power Connection

M804DSP amplifiers incorporate a power factor corrected power supply and can be used with mains input voltage from 100V AC to 240V AC, 50/60Hz. Use the mains cable supplied with the amplifier and connect it to a mains supply.

Press the front panel power button to switch on the amplifier. After a short delay the front panel Status indicator will illuminate green.

5.2 Network Services

M804DSP amplifiers are configured via the Control Web App interface. Before the Web App configuration menus can be accessed, M804DSP amplifiers must be connected to the same TCP/IP network as the computer or mobile device that is to be used for configuration.

5.2.1 Wired (Ethernet) Network Connection

To connect a M804DSP amplifier to a TCP/IP network using a wired connection (Ethernet) follow the steps below.

1. Use an Ethernet cable to connect the M804DSP amplifier rear panel Network Control socket to a free socket on a network router or switch, or directly to an Ethernet equipped laptop or desktop computer.
2. Connect the M804DSP amplifier to mains power using the supplied mains cable. Wait for the front panel Network indicator to illuminate green to indicate that the amplifier has network connectivity.
3. The M804DSP amplifier default LAN IP address is 192.168.64.100. Configure the laptop or desktop computer for a fixed IP address in the same IP range; eg. 192.168.64.10, with Subnet mask of 255.255.255.0 (or prefix 24) and set the Gateway to 192.168.64.1.
4. Open a laptop or desktop web browser and enter the address

<http://192.168.64.100>. The Control Web App interface will open to enable amplifier configuration as required.

Note: M804DSP amplifiers can be configured to use DHCP for network connection if required. However, if a M804DSP amplifier using DHCP is power cycled, it is possible that the TCP/IP network router will assign it a different IP address, leaving its configuration page inaccessible via the previous address. If this occurs, a network scanning app can be used to identify the new IP address. DHCP and Fixed IP address option settings can be found in the Settings Tab menu described in Section 5.3.

5.2.2 Wireless (WiFi) Network Connection

To connect a M804DSP amplifier to a TCP/IP network using a wireless connection (WiFi) follow the steps below.

1. With the M804DSP amplifier connected to mains power, wait for the front panel WiFi indicator to illuminate green.
2. Use a mobile, laptop or desktop device to search for available WiFi networks. Connect to, NEXT-proaudio M804DSP (product serial number)' using the password, '**password**'. The amplifier serial number can be found on its rear panel.
3. Open a computer or mobile device web browser and enter the IP address: 192.168.4.1. The Control Web App interface will open to enable amplifier configuration as required.
4. Select the Web App Settings Tab followed by WiFi > WiFi Mode > Client to configure the amplifier to connect to the required WiFi network. The WiFi network name and password will be required.

It is strongly recommended that the M804DSP amplifier Access Point WiFi password is changed following initial wireless connection.

Configuration

5.3 Configuration Menus

Opening a web browser that is network connected to a M804DSP amplifier initially displays the M804DSP Control Web App **Dashboard** illustrated in **Diagram 5A**. The Dashboard is the 'home' page from which all other configuration options can be accessed.

The Dashboard displays the amplifier status, output zones and the configuration menu tabs. It also enables immediate access to zone volume control. The functions available under each configuration menu tab are described in the following sections.

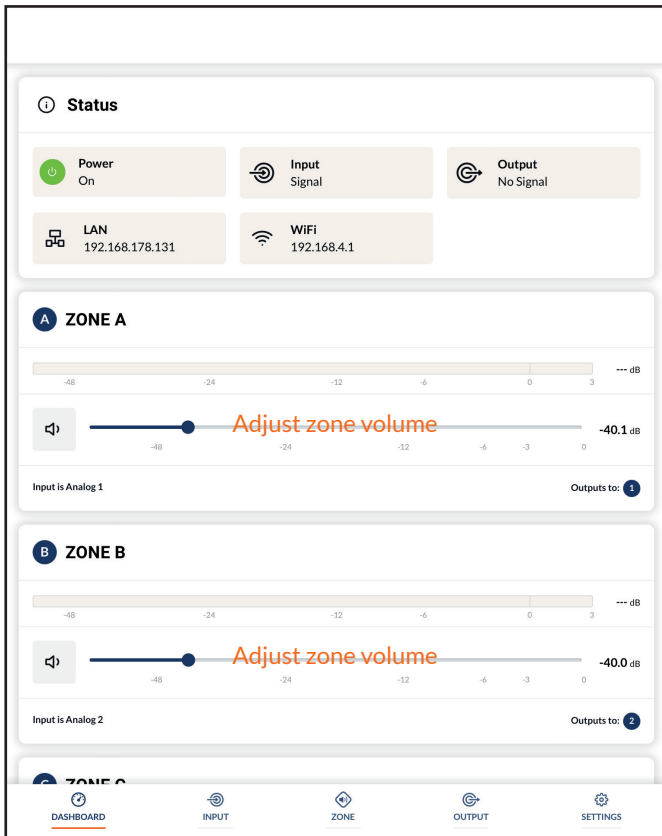

Diagram 5A
Configuration Dashboard display

5.3.1 Input Tab

The **Input Tab** provides the following configuration parameters for each amplifier input channel:

- **Input name**
- **Mono/Stereo selection**
- **Input sensitivity**
- **High-pass filter**
- **Gain trim**
- **Five band equalisation**

The **Input Tab** also enables input signals to be mixed and routed to specific amplifier zones. The mix function enables any amplifier input, including stereo or split mono S/PDIF inputs, to be grouped with any other input or inputs to create multiple predefined mixes.

Note: The number of individual mixes possible is equal to the number of amplifier analogue inputs.

Note: Mix inputs are muted by default with their level adjustment sliders set to zero.

Mix operations take place following high-pass filter, input equalisation and mono/stereo selection.

Diagram 5B
Input Tab display
(two inputs only shown)

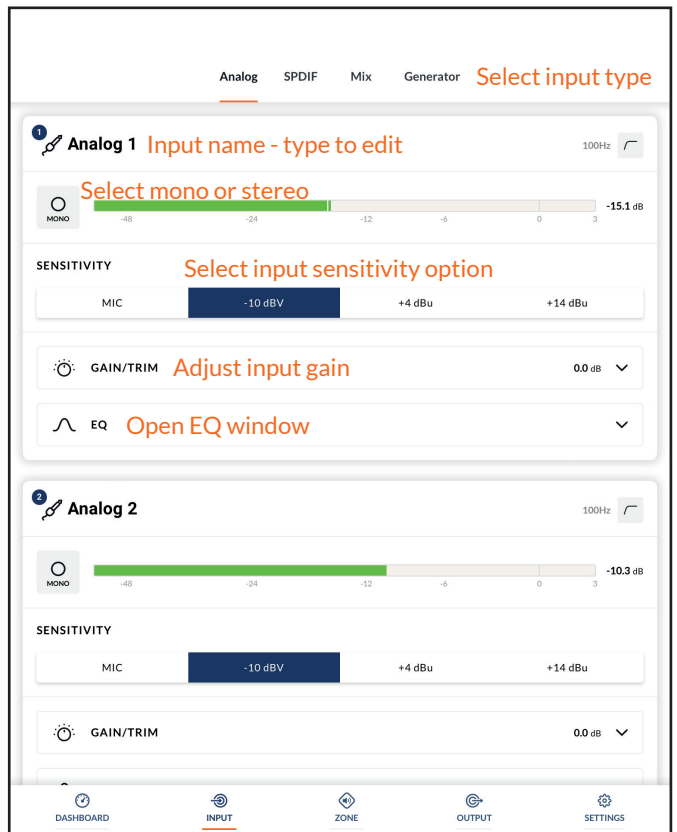

Note: When adjusting input gain, the input level display should remain green. If it displays red, the input gain should be reduced.

Configuration

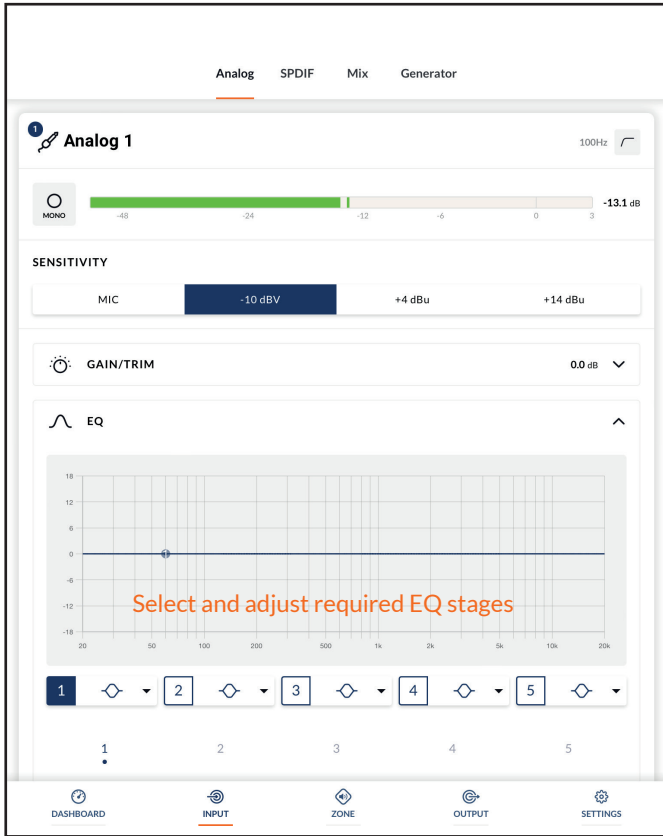

Diagram 5C
Input EQ display

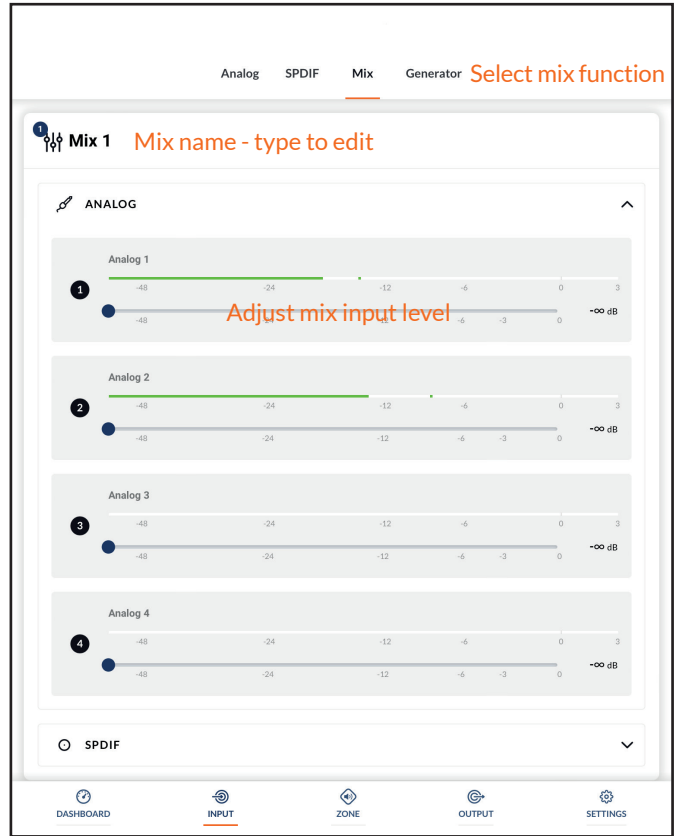

Diagram 5D
Input Mix display

A pink noise or sine wave audio signal **generator**, appropriate for audio system testing and set up, can also be enabled, disabled, and adjusted for gain and frequency via the **Input Tab**. **Diagrams 5B, 5C and 5D** illustrate the **Input Tab**, **Input EQ** and **Input Mix** displays respectively.

5.3.2 Zone Tab

The **Zone Tab** enables installation zones to be defined and named, and provides access to further sub-menus. Zones might be bar or restaurant areas for example, or different rooms in a home. For all Zone Tab menus, the installation zone under configuration is selected by highlighting one of the zone identifiers (A, B, C or D) at the top of the display. **Diagram 5E and 5F** illustrates the **Zone Tab** and **Source** menu displays.

- The **Source** menu enables inputs to be assigned to zones and **Input Priority** or **Input Ducking** to be configured. The **Input Priority** function enables an alternative input to replace and mute the input primarily routed to the zone under configuration when the alternative input exceeds a preset level.

The **Input Ducking** function enables an alternative input to replace and attenuate the input primarily routed to the zone under configuration when the alternative input exceeds a preset level.

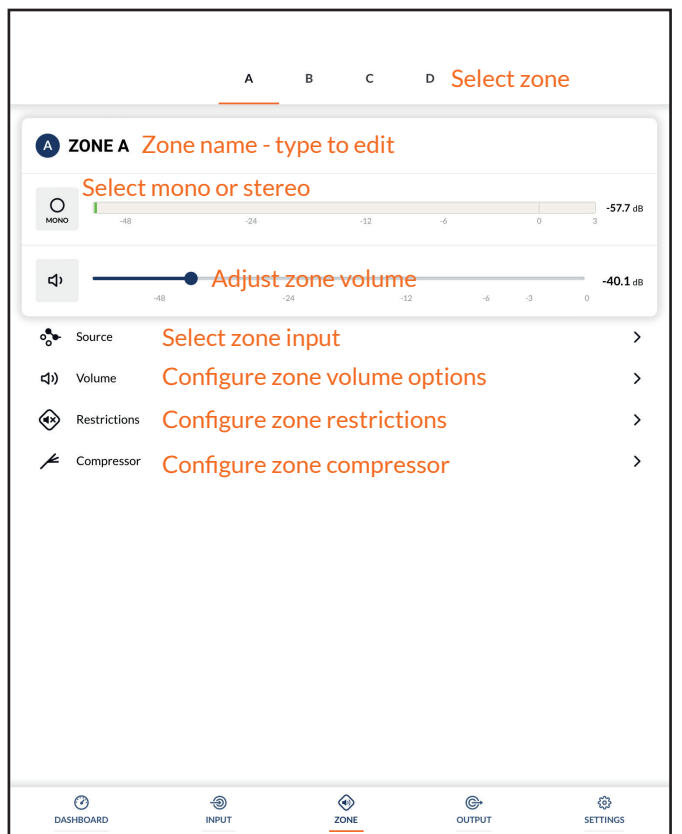

Diagram 5E
Zone Tab display

Configuration

Note: Input Priority and Input Ducking parameters can be either set to default values or their Threshold, Attack, Hold and Release values set as required. Input Priority can also be set to ignore the volume level set for the specified zone and take a specific override volume.

- The **Volume** menu allows minimum and maximum zone volume limits to be set, and enables external GPIO volume control to be applied to individual zones. The GPIO configuration menu can be found under the **Settings Tab**, and notes on connecting an external volume control via the GPIO interface can be found in Section 5.5 of this manual.

Note: If an amplifier is controlled via a third-party control system API, volume level limits set via the Input Tab will not apply.

- The **Restrictions** menu enables zone inputs or input mixes to be restricted from routing to particular zones.

Note: Routing restrictions cannot be applied to priority zone inputs.

Note: If an amplifier is controlled via a third-party control system API, input routing restrictions set via the Input Tab will not apply.

- The **Compressor** option enables default or custom signal compression to be applied to individual zones.

Note: Compression can be useful to reduce the volume difference between loud and quiet audio material. The lower the compression threshold is set, the more the difference between loud and soft will be reduced. The overall zone volume may need to be increased when compression is used. The default compression parameters are appropriate for most installations.

5.3.3 Output Tab

The **Output Tab** enables amplifier outputs to be named, linked to zones, and provides access to **Delay**, **Equalizer** and **Speaker Preset** menus. **Diagram 5G** illustrates the **Output Tab** display.

For all **Output Tab** menus, the amplifier output under configuration is selected by highlighting one of the output identifiers (1, 2, 3 or 4) at the top of the display.

Note: The number of individual outputs available for configuration will depend on the **M804DSP** amplifier model and the input, zone and output mode configuration.

- The **Routing** menu enables zones to be assigned to amplifier outputs.

Note: Routing for zones specified as stereo will automatically offer three output options: left channel, right channel or summed mono. The summed mono signal can potentially be used to drive a mono subwoofer.

- The **Delay** menu enables delay to be applied to individual amplifier outputs.

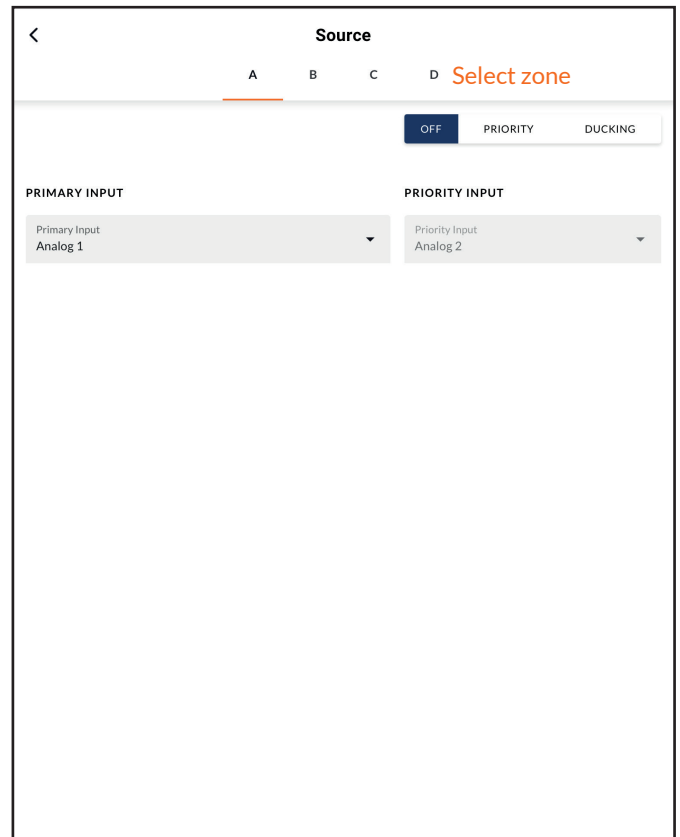

Diagram 5F
Zone Source menu display

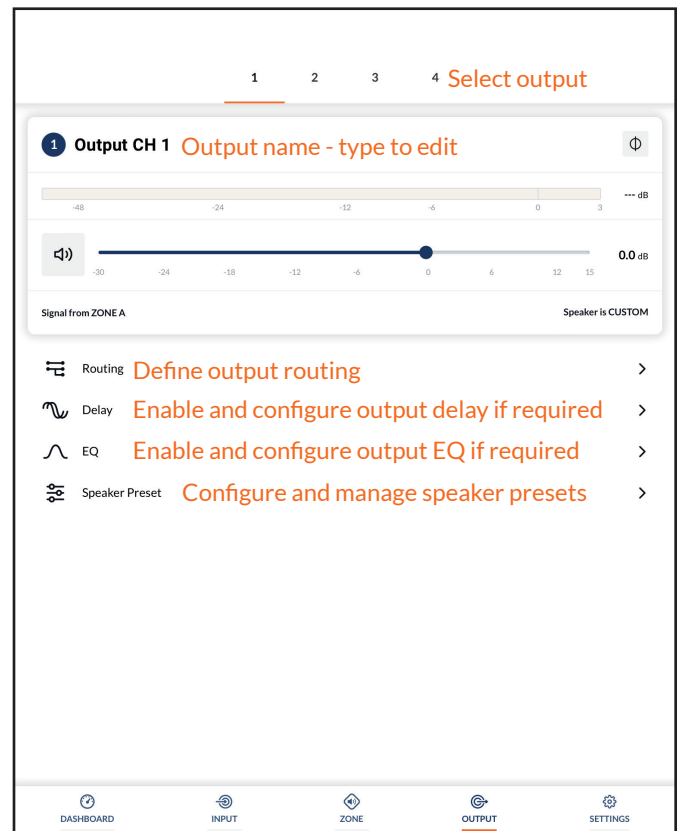

Diagram 5G
Output Tab display

Configuration

- The **Equalizer** menu enables parametric equalization to be applied to individual amplifier outputs. Equalizer settings configured for one amplifier output can be copied and applied to other outputs.
- The **Speaker Preset** menu enables a set of speaker parameters to be adjusted, and preset configurations to be created, exported, imported or cleared.

Speaker Presets can be simply applied to the selected amplifier output or imported, chosen from a library, exported or cleared. The preset configurations can include any or all of the parameters described in Section 5.3.4 and can be locked to prevent inadvertent modification. **Diagrams 5H to 5K** illustrate the application of speaker presets.

Speaker Preset data provided by third parties for use with specific speakers can be imported and applied to amplifier outputs. To import speaker preset parameters follow the steps described below and illustrated in the diagrams.

1. Select either the **IMPORT PRESET FROM LIBRARY** or **SELECT PRESET FROM FILE** option from the **Speaker Preset** menu. If no import option is visible, select **CLEAR** to delete any existing speaker preset data.

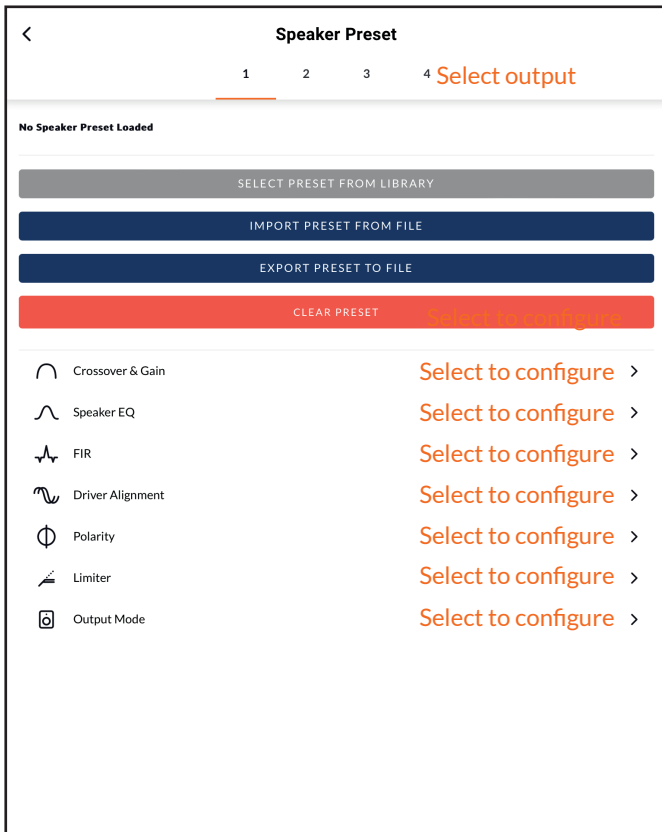
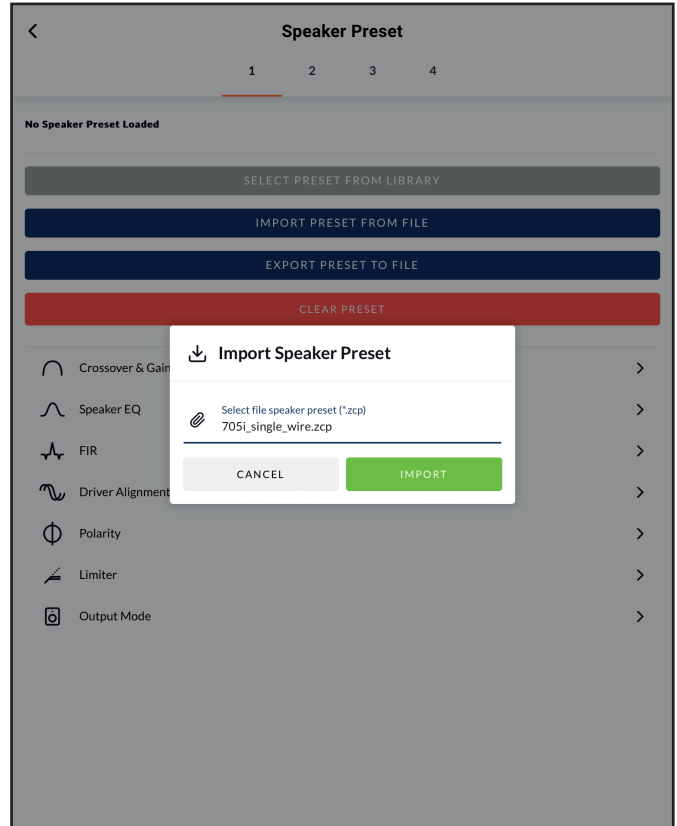

Diagram 5H
Speaker Preset Parameters

Diagram 5I

Speaker Preset import file selection



Note: The SELECT PRESET FROM LIBRARY option will be unavailable if no speaker preset libraries have been created. Speaker preset library creation and management is described in Section 5.3.5.

2. Select the appropriate '.zcp' format speaker preset data file to import from either a Library or a computer folder. The preset data will be applied to the selected amplifier output as soon as the file import is complete.
3. If the Speaker Preset data requires modification it can be customized by selecting the CUSTOMIZE PRESET option.

Note: If an imported Speaker Preset data file includes locked parameters, they will be unavailable for modification.

5.3.4 Speaker Preset Menu Parameters

- The **Crossover & Gain** preset menu enables high or low-pass crossover filters and gain adjustment to be applied to individual amplifier outputs.
- The **Speaker EQ** preset menu enables parametric equalization to be applied to individual amplifier outputs.
- The **FIR** preset menu enables FIR (Finite Impulse Response)

Configuration

Diagram 5J

Speaker Preset applied

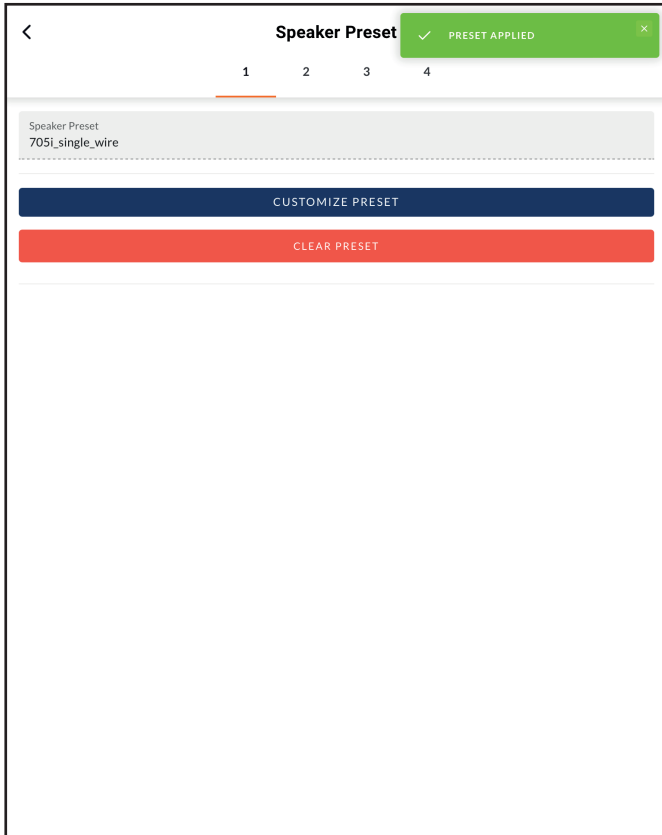
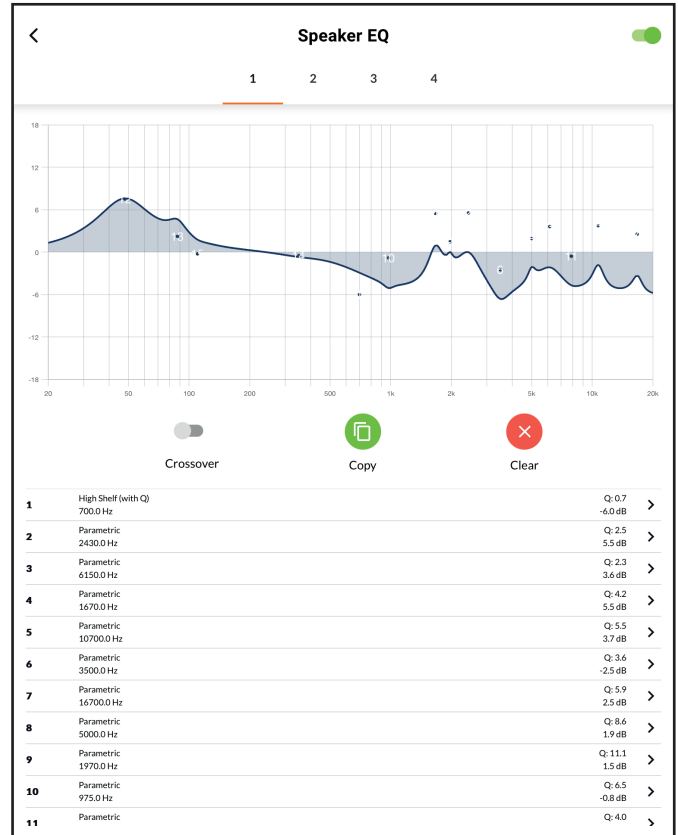

Diagram 5K

Speaker Preset parameter adjustment



based equalization filter coefficients generated by external speaker measurement software to be imported and applied to individual amplifier outputs.

Note: FIR coefficient files in either .csv or .txt format can be imported.

- The **Driver Alignment** preset menu enables delay to be applied to individual amplifier outputs.
- The **Polarity** preset menu enables the polarity of individual amplifier outputs to be reversed.
- The **Limiter** preset menu enables signal limiting to be engaged or bypassed on individual amplifier outputs. **Clip** limiting, **Peak** limiting and **RMS** limiting can be individually or collectively engaged. The Clip limiting function offers Fast and Normal response time options. The Peak limiting function can be set to either Automatic or Manual parameter values. The RMS Limiter has default parameter values that can be adjusted but has no automatic option.

Note: It is strongly advised that if an amplifier is driving low impedance loads (<4Ω) the Clip Limiter should be engaged and set to Fast.

Note: In automatic mode, the peak limiter parameters adjust automatically in response to Crossover & Gain high-pass filter settings.

- The **Output Mode** preset menu enables individual amplifier outputs to be switched off or configured for Lo-Z or Hi-Z modes. In Hi-Z modes, a high-pass filter can also be configured and applied to the output. The number of outputs available will depend on the amplifier model, input setup and zone setup. For example, a two output amplifier will have two outputs available if Lo-Z mode is selected but only one output available if Hi-Z mode is selected.

Note:: Use of a high-pass filter with Hi-Z mode loudspeakers is useful to avoid the possibility of distortion caused by low frequency line transformer saturation. Begin with the default filter setting of 70Hz. If low frequency distortion is still audible, increase the frequency setting one step at a time until the distortion is no longer audible.

5.3.5 Settings Tab

The **Settings Tab** enables miscellaneous amplifier settings to be configured and installation data to be recorded.

Configuration

The Settings Tab provides access to further sub-menus. **Diagram 5L** illustrates the **Settings** Tab.

- The **System Information** menu provides text fields for the recording of installation data.
- The **Device** menu records amplifier specific information such as the model number and firmware version. A firmware update routine and identifier button can also be found under the Device menu.
- The **External Devices** menu enables control panels to be paired with an amplifier and configured. Each individual amplifier zone to be controlled will require its own control device. **Diagram 5M** illustrates the **External Devices** display.
- The **Backup & Restore** menu enables amplifier configuration data to be downloaded to an external archive, and enables previously saved configuration files to be uploaded and adopted by the currently connected amplifier.
- The **Speaker Library** menu enables management of speaker preset libraries. Existing libraries of speaker preset files (.zcl) can be created or imported, and existing libraries edited or fully deleted. **Diagram 5N** illustrates the creation and

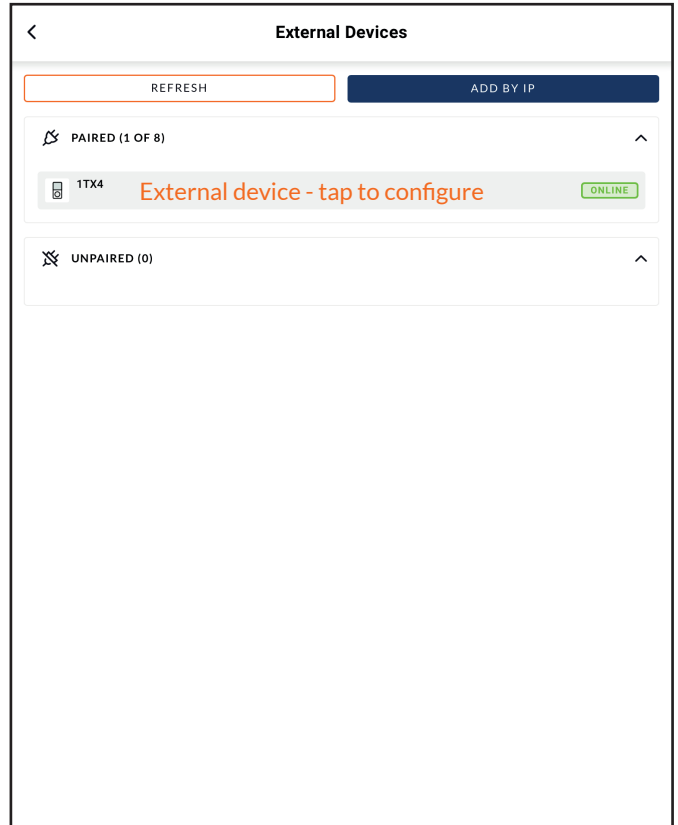

Diagram 5M
The External Devices display

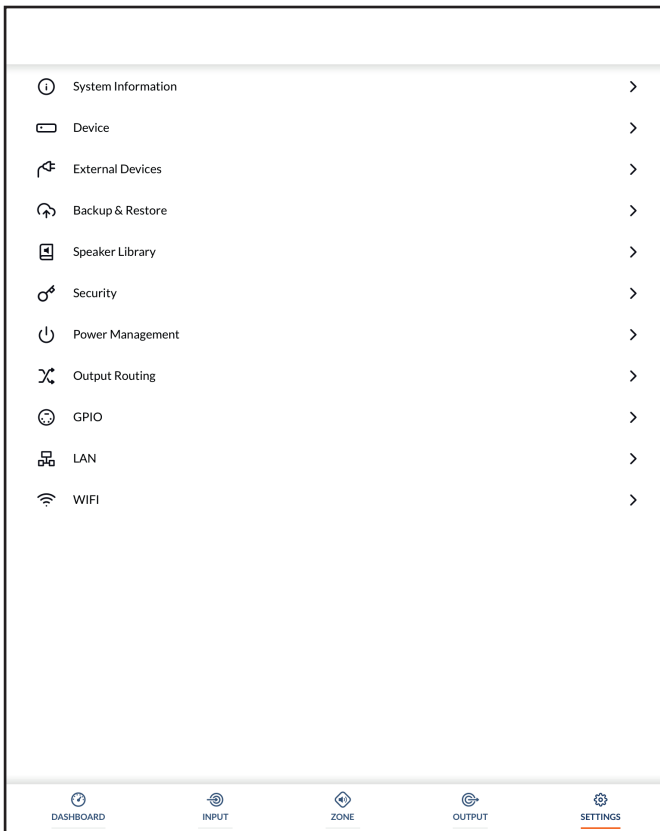

Diagram 5L
Settings Tab menu

Configuration

management of speaker preset libraries.

- The **Security** menu enables a password to be set in order to protect against unauthorised access to the amplifier Control Web App. Password protection is particularly important when an amplifier is connected to a wired network as the a WiFi password is no longer required to gain access to Control Web App.

Note: It is recommended that a Control Web App password is different from that required to gain access to the amplifier via WiFi.

- The **Power Management** menu enables various automatic switch-on options to be engaged. The Power Management menu also offers timed Standby and Mute functions.
- The **Output Routing** menu enables specified inputs or zones to be routed to the amplifier S/PDIF outputs. The output level can also be adjusted.

Any zone or input can be routed to either digital output, including inputs not actively assigned to a zone. Primary or priority input status is immaterial. The specified input is always routed to the specified output to be available for use by downstream devices.

Note: The digital output function is especially useful when amplifiers are to be daisy chained and a specific input; a central paging mic, for example, is required to be routed to multiple amplifiers..

- The **GPIO** menu enables configuration of the multi-purpose GPIO interface pins.
- The **LAN** menu enables configuration and reset of the wired network options and parameters.
- The **WiFi** menu enables configuration and reset of the wireless network options and parameters.

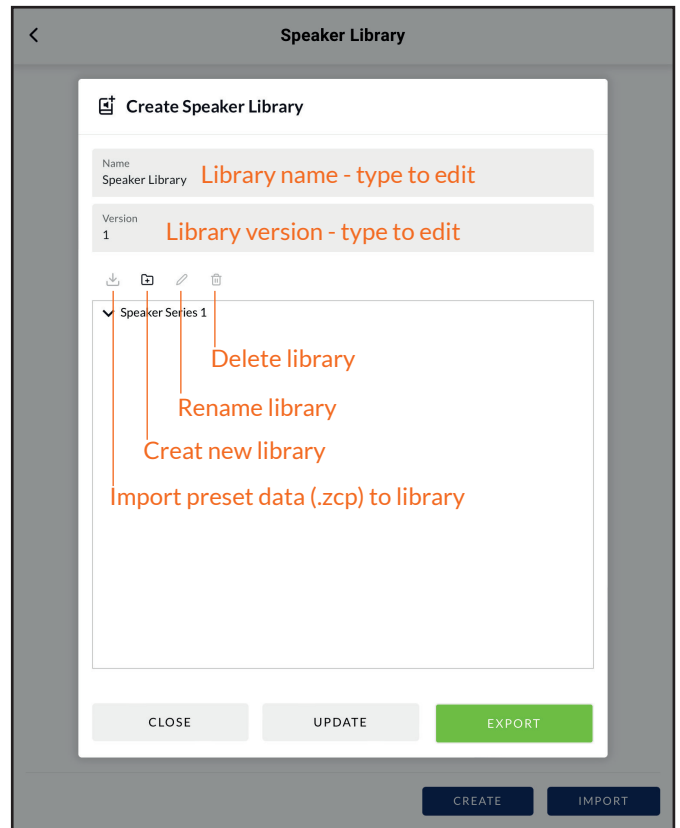

Diagram 5N
Speaker Library Creation and Management

Configuration

5.4 Setup and Signal Routing

Thanks to their network based configuration features, M804DSP amplifiers offer considerable versatility in terms of sources, signal routing, installation zones and output modes. Inputs can be freely assigned to installation zones, and those zones assigned freely to the available amplifier outputs in either Lo-Z or Hi-Z modes.

This versatility enables, for example, one amplifier simultaneously to drive both Lo-Z and Hi-Z speakers, or for different inputs to be routed to different output zones.

The following paragraphs describe and illustrate the recommended procedure for configuring input, zone and output routing. A general signal flow schematic is also illustrated in Diagram 50.

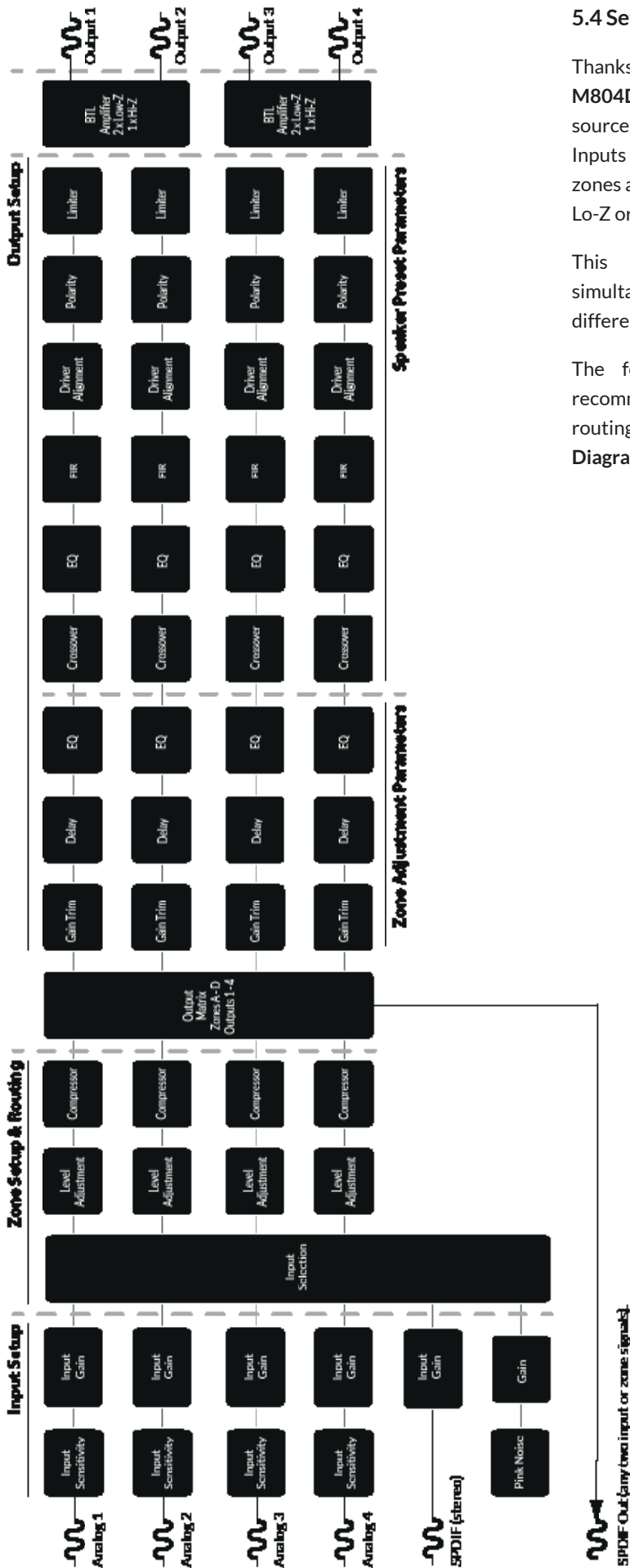

Diagram 50
Signal Flow Schematic
(four output amplifier)

Configuration

5.4.1 Input Setup

Open the configuration Dashboard and select the **Input Tab**. The Input Tab is shown in **Diagram 5B**.

- To edit default input names simply select and type in the Input Name field.
- Define a mono or stereo input by selecting the appropriate option. Defining a stereo input will reduce the total number of discrete inputs available.
- Select an input sensitivity option from the drop-down menu: +14dB, +4dB, -10dB and 'microphone' options are available. Generally, the +14dB or +4dB options are appropriate for 'professional audio' source hardware with balanced outputs, while the -10dB option is more appropriate for 'consumer audio' source hardware with unbalanced outputs. The 'microphone' option provides the significantly greater sensitivity required for microphones.

Note: Only dynamic microphones are suitable for connection. Phantom power for condenser microphones is not provided.

- If necessary, adjust the input gain using the slider or up/down icons. Gain adjustment is intended to be used for fine output level adjustment following initial use.

5.4.2 Zone Setup & Routing

Open the configuration Dashboard and select the **Zone Tab**. The Zone Tab is shown in **Diagram 5E**.

- Select the zone to be configured. The number of zones available and their channel format (stereo or mono) will depend on the amplifier model, input setup and output mode (Lo-Z or Hi-Z). For example, a two output amplifier can have the following zone configurations:
 - 1 x stereo Lo-Z zone
 - 2 x mono Lo-Z zones
 - 1 x mono Hi-Z zone
- A four output amplifier can have the following zones configured:
 - 2 x stereo Lo-Z zones
 - 4 x mono Lo-Z zones
 - 2 x mono Hi-Z zone
 - 1 x mono Hi-Z zone + 1 x stereo Lo-Z zone
 - 1 x mono Hi-Z zone + 2 x mono Lo-Z zones

Note: When configured in Hi-Z mode M804DSP amplifiers operate in 'bridged' mode where the output of two channels is combined. This means that the number of output channels available in Hi-Z mode is half that available in Lo-Z mode .

Note: Mono signals might be mono at source, created though combining the left and right channels of a stereo signal (summed mono) or treating the left and right channels of a stereo signal independently (split mono).

- Name zones by typing in the Zone Name field.
- Adjust the zone volume if required by using the slider.
- Define a mono or stereo zone by selecting the appropriate option. Defining a stereo zone will reduce the total number of further zones available.
- Specify an input for the zone by selecting from the drop-down menu. Selecting a stereo input for a mono zone will automatically sum the stereo channels to mono.

Configuration

5.5 GPIO Setup and Connection

Diagram 5P

GPIO Settings Menu

M804DSP amplifiers provide a GPIO socket that enables remote control of volume, standby, mute and trigger functions. The GPIO connector pin functions are described in the **GPIO Settings** menu illustrated in **Diagram 5P**. The connection of GPIO based remote volume control and standby/mute are illustrated in **Diagram 5Q** and **Diagram 5R** respectively.

Note: The GPIO connector must not be used for any unintended purpose. Amplifier damage may result from incorrect use of GPIO.



Note: Shielded cable must be used when connecting standby switches and potentiometers via GPIO.



Note: GPIO Pin 8 has a low output impedance and is able to supply a maximum current of 10mA.



Note: GPIO Pin 1 and Pin 3 both offer ground connections: Pin 1 is connected directly to the amplifier chassis. Pin 3 is connected to the chassis via a 220 Ohm resistor. The 'soft ground' connection of Pin 3 is potentially useful for managing ground loops that may cause audible hum.

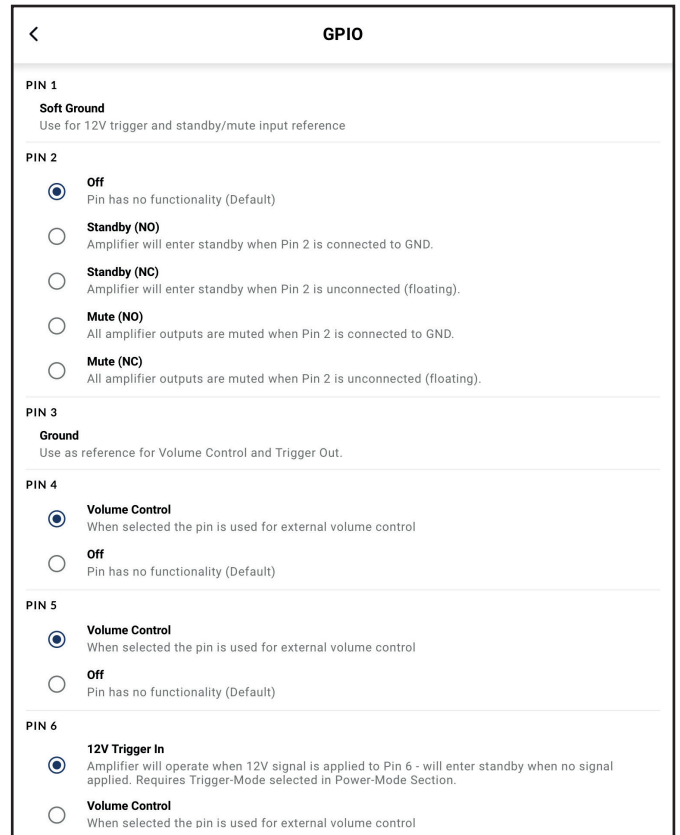

Diagram 5Q

Potentiometer connections for remote volume control via GPIO.

Note: Diagram 6D illustrates use of the GPIO connector.

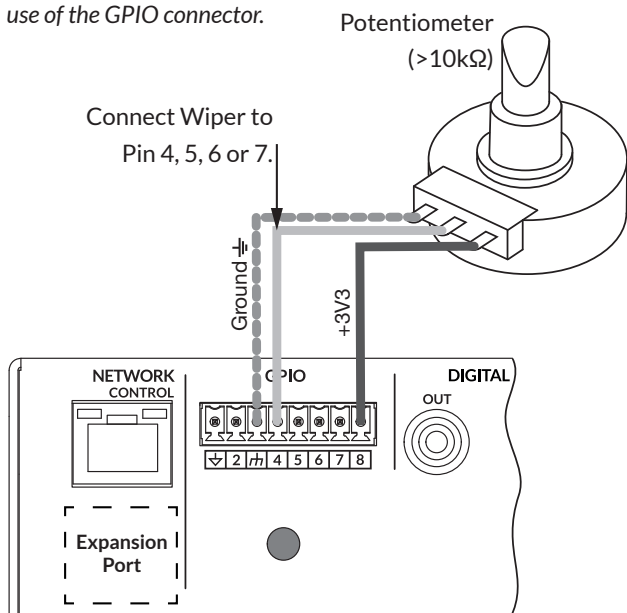
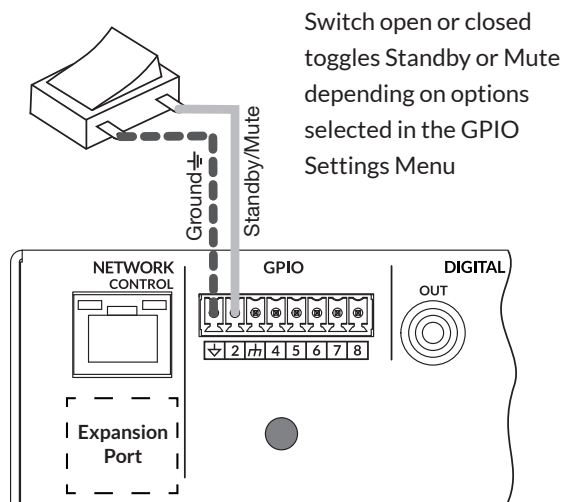

Diagram 5R

Connections for remote standby/mute switch via GPIO.

Note: Diagram 6D illustrates use of the GPIO connector.



Connections

6. Connections

M804DSP amplifier rear panel connections are illustrated in Diagrams 6A.

6.1 Mains Power Connection

M804DSP amplifiers incorporate a power factor corrected universal power supply and can be used with mains input voltage from 100V AC to 240V AC, 50/60Hz. Use the mains cable supplied with the amplifier.

M804DSP amplifiers incorporate a front panel mounted power button. Press the button once to switch the amplifier on or off. Ensure that all signal, GPIO and output connections are made before switching on the amplifier.

6.2 Input Connection

M804DSP amplifier provide four balanced or unbalanced analog audio inputs and a stereo S/PDIF digital audio input. Any input channel can be routed to any output channel. Input routing options can be configured via the Control Web App **Input Tab**. See Section 5 of this manual.

Analog Inputs

M804DSP analog inputs are of line level format with a default input sensitivity of +4dBu (full output voltage swing/sensitivity) in all output modes. Depending on the selected sensitivity, the inputs can handle up to +24dBu without clipping. Input sensitivity options can be set via the Control Web App **Input Tab**. See Section 5 of this manual.

Balanced input connections to the amplifiers are made via male 'Euro Block' connectors. Connecting cables to the supplied female input connectors is illustrated in Diagram 6B.

Unbalanced input connections to the amplifiers are made via RCA phono sockets connected in parallel with the balanced inputs.

Digital Outputs

M804DSP Connect S/PDIF stereo digital audio output connections are made via a single RCA Phono socket. The S/PDIF output signal can be routed from any input or zone and is intended to be used for daisy-chaining M804DSP Connect amplifiers.

Note: See the Output Routing paragraphs of Section 5.3.3 for more information on Digital Output configuration.

Note: 75Ω RCA Phono cables specifically intended for digital audio should always be used for S/PDIF connections. Standard Phono cables can be used but may not result in optimal performance.

Note: The S/PDIF output level is by default set at -10dB to reduce the possibility of downstream input clipping.

6.3 Output Connections

Output connections from the amplifiers are achieved via male 'Euro Block' connectors. Ensure that speaker connection polarity is correct throughout the installation:

In the case of Lo-Z speaker connections, positive (+) amplifier terminals should always be connected to positive speaker terminals and negative (-) amplifier terminals always connected to negative speaker terminals.

In the case of Hi-Z speaker connections, the two speaker cable conductors should be connected between the positive (+) terminal of Output 1 and the negative terminal (-) of Output 2, and likewise for Outputs 3 and 4.

Output mode options (Lo-Z or Hi-Z) can be configured via the Control Web App **Input Tab**. See Section 5 of this manual.

Connecting cables to the supplied female output connector is illustrated in Diagram 6C.

Diagram 6A

M804DSP rear panel connections.

Note: Two output amplifier model connection sockets differ only in the deletion of channel 3 and channel 4 output connectors.

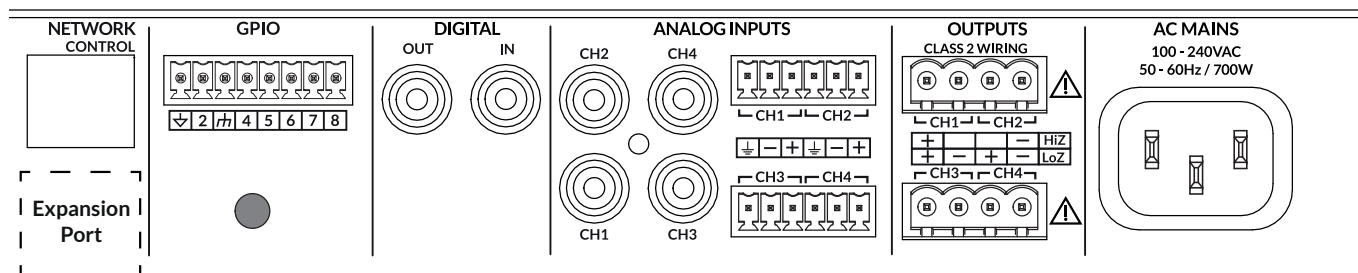

Connections

6.4 Speaker Cable Gauge

M804DSP speaker connection cable gauge should be chosen appropriately to reflect the type of installation. The adjacent tables specify the appropriate cable gauge and maximum cable length for less than 0.5dB cable loss in Lo-Z mode and less than 1.0dB cable loss in Hi-Z mode.

6.5 GPIO Connections

If any M804DSP GPIO functionality is required, cables will need to be connected to the supplied GPIO connector. Connecting cables to the GPIO connector is illustrated in Diagrams 6D.

6.6 Network Connections

M804DSP amplifiers are TCP/IP network connected devices that are configured via a webpage based interface. Wired (Ethernet) and wireless (WiFi) connection options are available. Connecting M804DSP amplifiers to a TCP/IP network is described in Section 5 of this manual

Cable Gauge Table

Lo-Z installations, 0.5dB attenuation. 2 Ω, 4 Ω & 8 Ω loads

Cable Cross Section (mm ²)	Cable Gauge (AWG)	Max Cable Length (Metres, 2 Ω load)	Max Cable Length (Metres, 4 Ω load)	Max Cable Length (Metres, 8 Ω load)
0.75	≈18	N/A	5	10
1.5	≈16	5	10	20
2.5	≈14	8	17	35
4.0	≈12	14	28	55

Cable Gauge Table

70V Hi-Z installations, 1.0dB attenuation
20 speakers evenly distributed

Cable Cross Section (mm ²)	Cable Gauge (AWG)	Max Cable Length (Metres), (1000 W/channel)	Max Cable Length (Metres), (1200 W/channel)
0.75	≈18	25	20
1.5	≈16	50	40
2.0	≈14	80	60
3.5	≈12	125	100

Cable Gauge Table

100V Hi-Z installations, 1.0dB attenuation
20 speakers evenly distributed

Cable Cross Section (mm ²)	Cable Gauge (AWG)	Max Cable Length (Metres), (1000 W/channel)	Max Cable Length (Metres), (1500 W/channel)
0.75	≈18	50	30
1.5	≈16	100	60
2.0	≈14	160	100
3.5	≈12	250	160

Connections

Diagram 6B
Balanced analog input
cable connections.

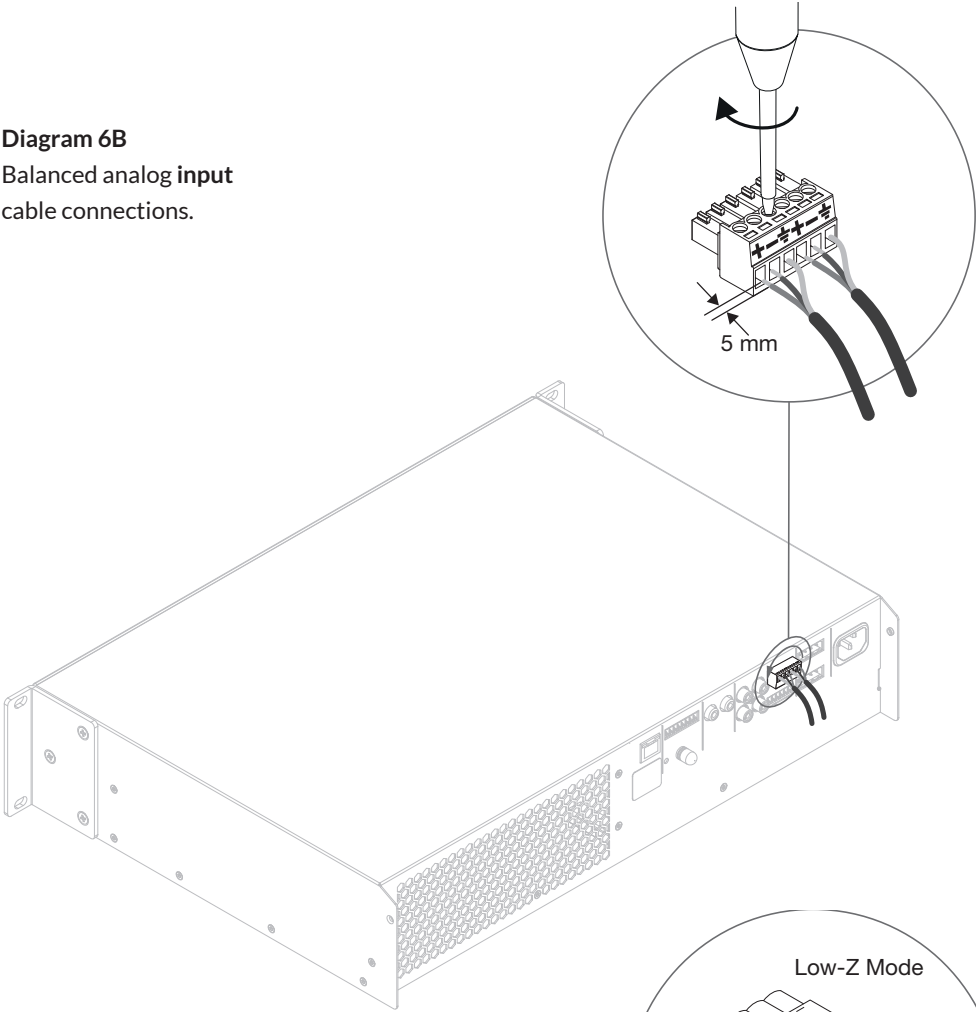
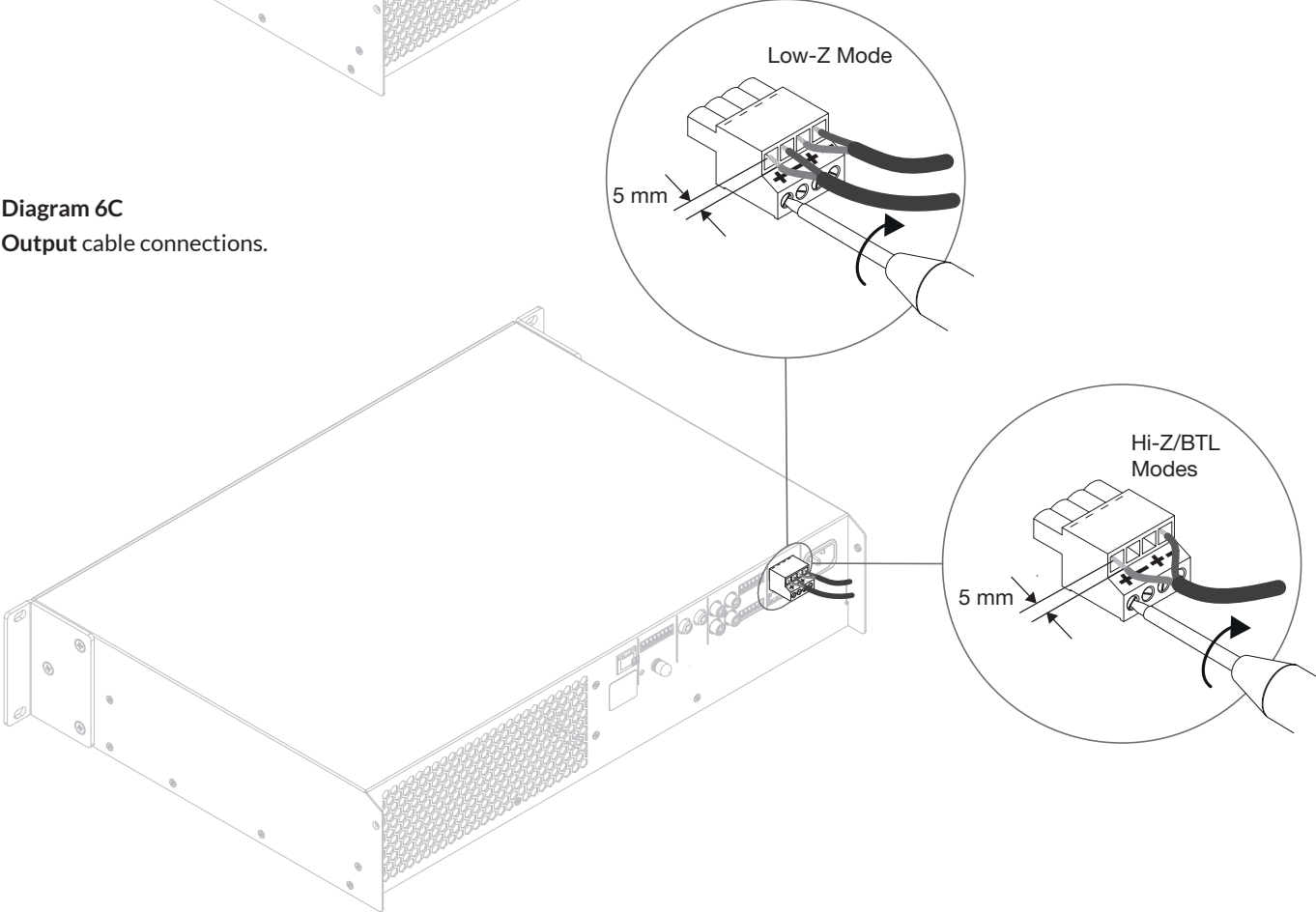
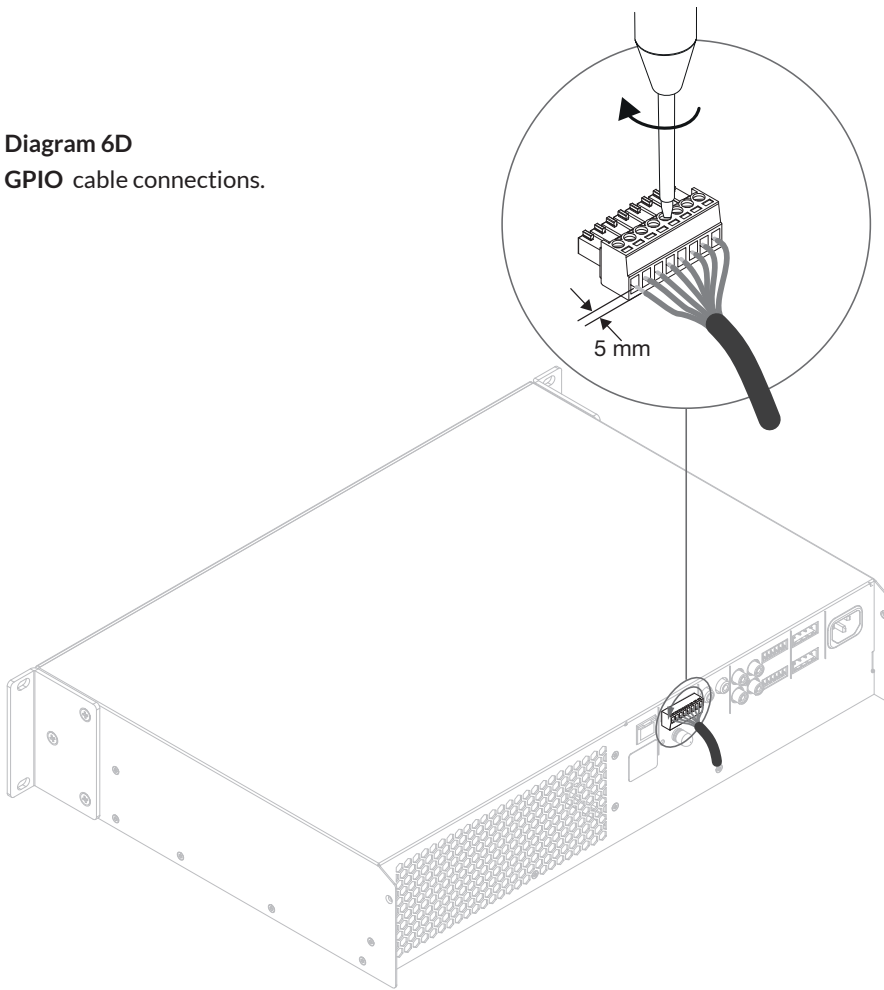

Diagram 6C
Output cable connections.



Connections

Diagram 6D
GPIO cable connections.



The exclamation point printed next to the output terminals of the amplifiers is, in addition to the CLASS 2 WIRING text, intended to alert users to the risk of hazardous voltages. Output connectors that could pose a risk are marked with the exclamation point. Do not touch the output terminals while the amplifier is switched on. Make all connections with the amplifier switched off.

Operation

7. Operation

Once all connections have been made and configuration options selected, M804DSP amplifiers are ready for use. If an input signal above -60dB is present on any input, the front panel Input and Standby indicators will illuminate green to indicate normal amplifier operation. Audio will be heard from any connected speakers.

Note: M804DSP amplifiers will by default not wake from Standby Mode unless an input signal is present, a network 'ON' command is received, or an external standby switch (or 12V trigger) is operated. Standby behaviour can be configured via the Power Management menu of the Control Web App Settings Tab.

Amplifier outputs will mute if no input signal is present for 5 minutes, and the amplifier will switch automatically to Standby Mode if no signal is present on any input for more than 15 minutes. Alternative standby and mute delay times can be selected via the **Settings Tab**. Amplifier cooling fan speed is temperature controlled. The fan will switch off when the amplifier enters standby mode.

7.1 Front Panel Indicators

M804DSP amplifier front panel indicators illuminate to indicate the following operational states:

- Status:** Off – Mains power disconnected.
Green – Amplifier operational.
Pulse Green – Standby Mode.
Amber – GPIO triggered Standby Mode
- Input:** Off – No input signal present.
Green – Signal present on one or more inputs.
Amber – Signal limiting/clipping on one or more inputs.
- Output:** Off – No output signal present.
Green – Signal present on one or more outputs.
Amber – Signal limiting/clipping on one or more outputs.
Red – One or more channel pair is in overload/protection mode.
- Network:** Off – No Ethernet network detected.
Green – Ethernet network detected.
- WiFi:** Off – WiFi disabled.
Green – WiFi enabled.

7.2 Default Reset

M804DSP amplifiers can be returned to their default settings via either the Control Web App **Settings Tab** or through the front panel power button.

To reset the amplifier using the front panel power button, follow the steps below:

- Disconnect the amplifier from mains power.
- Press and hold the front panel power button while simultaneously reconnecting mains power.
- Continue to hold the front panel power button for 3 to 5 seconds as the amplifier restarts.

The amplifier will restart with all settings at their default state. Any previously configured settings will be deleted.

Specifications

Model	M804DSP
Channels	4 x Lo-Z/2 x Hi-Z
Output Power @ 2Ω	4 x 750 W (SE)
Output Power @ 4Ω	4 x 750 W (SE) 2 x 1500 W (BTL)
Output Power @ 8Ω	4 x 400 W (SE) 2 x 1500 W (BTL)
Output Power @ 70V	2 x 1200 W (BTL)
Output Power @ 100V	2 x 1500 W (BTL)
Total System Power	3000 W
Power Consumption	700 W
Output Voltage	80 Vp / 160 Vpp (SE unloaded) 160 Vp / 320 Vpp (BTL unloaded)
Weight	7.4 kg
Dimensions	88 x 440 x 332 mm (3.5 x 17.3 x 13.1 in)
Output Circuitry	UMAC™ Class D - full bandwidth PWM modulator with ultra-low distortion
Signal To Noise-Ratio	>108 dB (A-weighted, 20 Hz-20 kHz, 8 Ω load)
THD+N (typical)	< 0.05 % (20 Hz-20 kHz, 8 Ω load, 3 dB below rated power)
Frequency Response	20 Hz-20 kHz (+0/-0.5 dB (8 Ω load, 3 dB below rated power)
Protection Circuits	Short circuit -, DC -, Undervoltage -, Temperature - and Overload protection
Power Supply	UREC™ universal mains switch mode power supply with Power Factor Correction (PFC) and standby converter
Operating temperature	0-40° C
Operating Voltage/ Frequency	Universal Mains, 100 V-240 V, 50 Hz-60 Hz
Standby Consumption	<0.5 W
Accessories	2x rack ears, 4 x adhesive feet
Power Ratings	1 % THD @ 120 Vac and 230 Vac

*SE - conventional, single ended output mode

**BTL - bridge-tied load output mode