

RRDJMA9

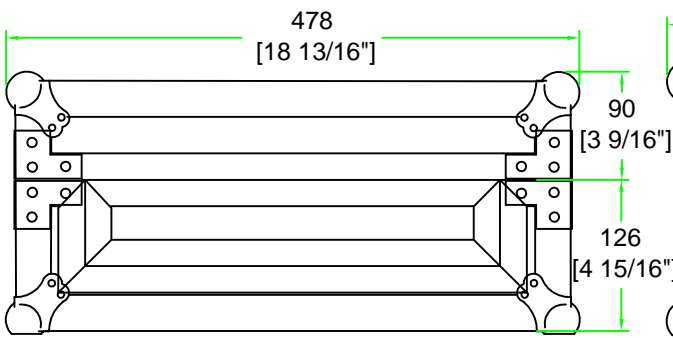

FRONT VIEW

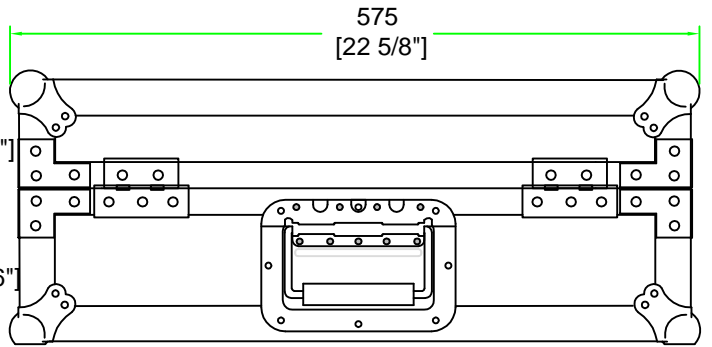

LEFT VIEW

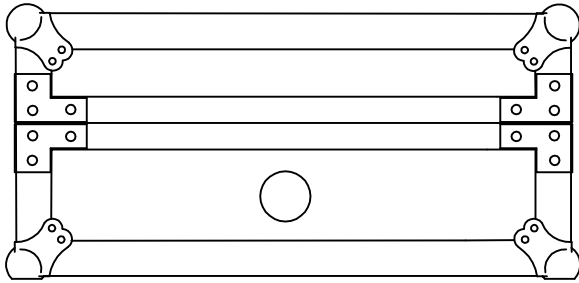

BACK VIEW

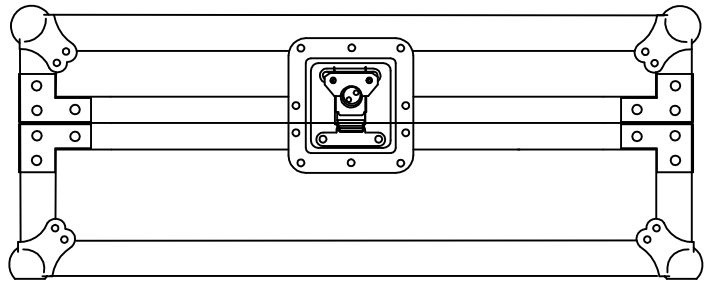

RIGHT VIEW

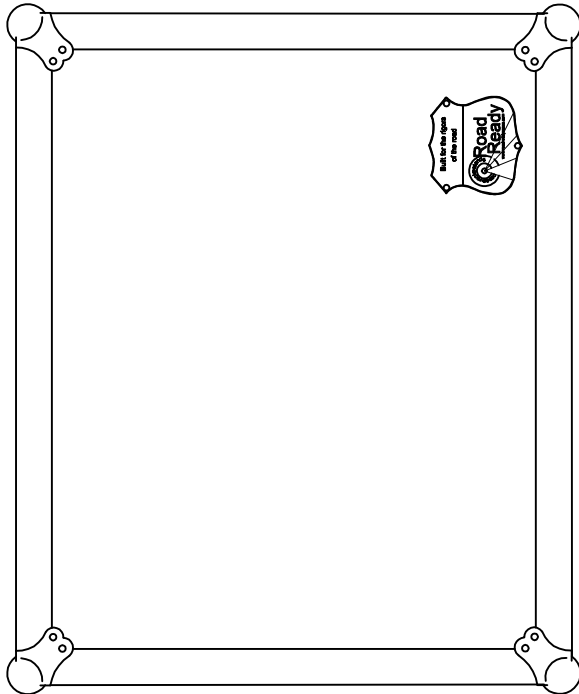

TOP VIEW

	SKU: RRDJMA9	BY: ROAD READY CASES
	UPC: NA	APPROVAL SIGNATURE: _____ DATE: _____
DRAWING DATE: 03 / 14 / 2023	SCALE: 1:6	DRAWING NUMBER: 1/2
		REVISION: NA

RRDJMA9

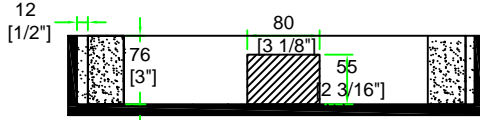

A-A VIEW

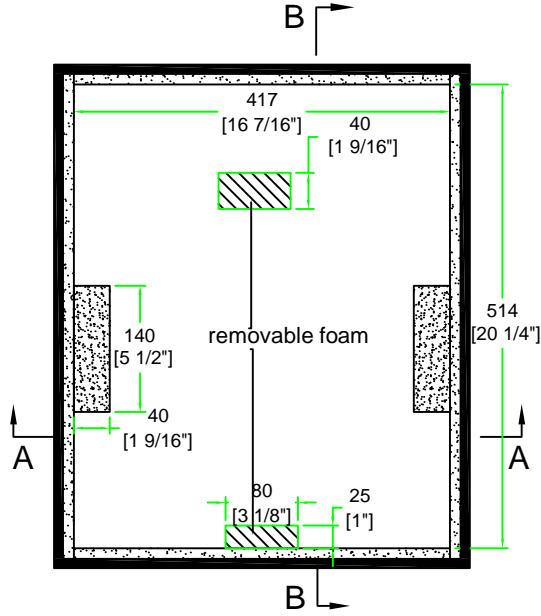

TOP VIEW OF COVER

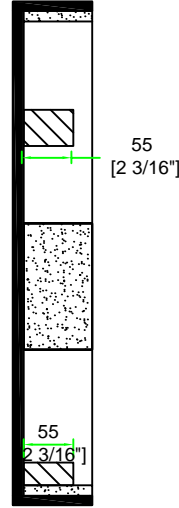

B-B VIEW

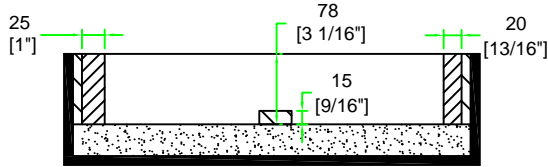

C-C VIEW

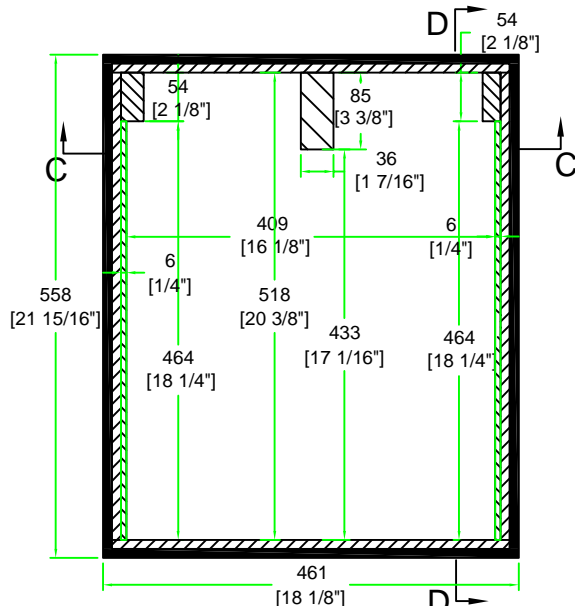

TOP VIEW OF BASE

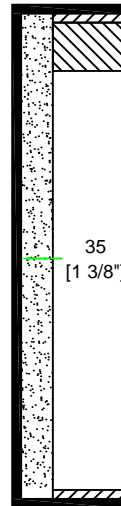

D-D VIEW



SKU: RRDJMA9	BY: ROAD READY CASES
UPC: NA	APPROVAL SIGNATURE: _____ DATE: _____
DRAWING DATE: 03/14 / 2023	SCALE: 1:8
DRAWING NUMBER: 2/2	REVISION: NA