

tonar

specialist in styli, cartridges and accessories for vinyl
www.tonar.eu



tonar

specialist in styli, cartridges and accessories for vinyl
www.tonar.eu

Since 1954, Tonar has become the specialist for phonograph styli, cartridges and accessories for your turntable and vinyl collection. Whether you belong to the new generation of vinyl lovers, or are already an experienced analogue High End HiFi enthusiast, our aim is to provide you with all essential tools necessary to fully enjoy your record collection.

While the concept of the record player is old, the means to enjoy analogue audio stay up-to-date. As we speak, new innovations are developed to improve every aspect of the turntable as well as the quality of vinyl records. Yet, with our longstanding experience, we are also committed to keep vintage parts and technologies available.

Originally, Tonar was founded as an O.E.M supplier, specializing in the field of synthetic sapphire products, such as bearings for watches, gas meters and other instruments. These parts were sold to industrial users. Soon a phonograph cartridge manufacturer contacted us to purchase sapphire tips for their phonograph needles. This was the first step into what is currently our core business – replacement styli and cartridges for record players.

Tonar now boasts a huge collection of phonograph replacement needles, original needles, phonograph cartridges and accessories for vinyl. Our current line consists of more than 3000 replacement needles and original needles, as well as more than 1500 different types of phonograph cartridges. We offer special shape cartridges for old record players where only one cartridge model will fit, as well as standard ½ inch mount cartridges, T4P-plug-in cartridges, crystal, ceramic, moving magnet, induced magnet, moving iron and moving coil type cartridges. Our cartridges and styli are not only used in hi-fi record players but also in 78 RPM Pathe-phone's, vintage record players and juke boxes.

As we share a passion for analogue sound reproduction, Tonar tries to keep supplying you with every item you may require to bring or keep your HiFi record player up and running, whether it be a stylus, a cartridge, a new turntable belt or even many other original or replacement parts that you require in order to enjoy listening to your vinyl records. You will find many examples of these products in this leaflet which only barely touches the surface of our complete assortment.

*More than
3000 different
phonograph styli
available!*

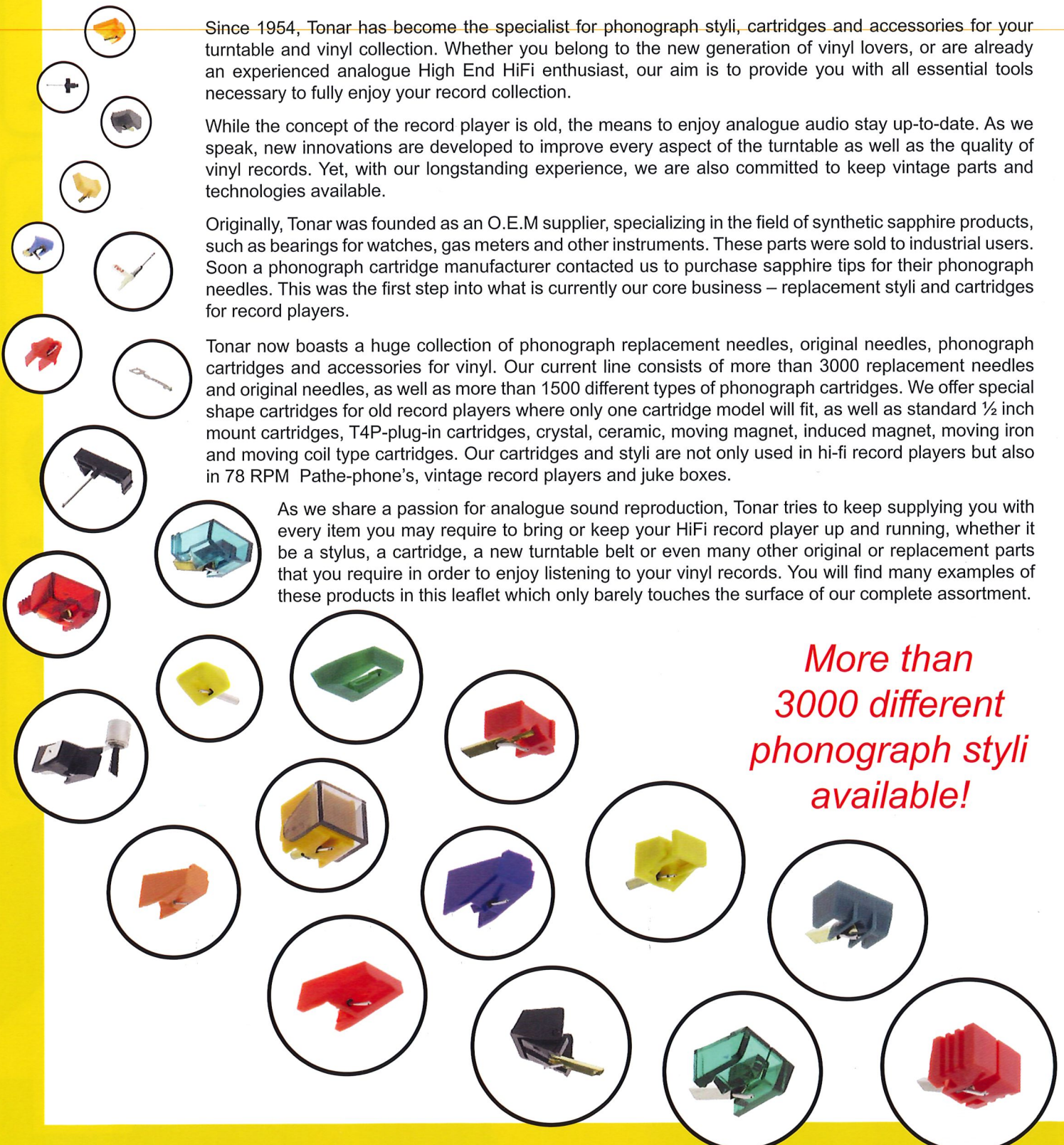

tonar

Vinyl Cleaning Essentials

When playing a record or even when taking the record out of its sleeve, it becomes static. This is because the surface of a vinyl record is not conductive and any static charge that develops remains. A static record attracts lots of dust and (pet) hairs, which not only affects the sound quality, but ultimately degrades the life of your vinyl collection, or damages the stylus of your record player. Tonar offers various easy-to-use tools to keep your valuable vinyl collection dust free, extending the life of your favorite recordings.

3180 – Tonar Nostatic Brush (carbon fibres)



The Tonar Nostatic Brush contains more than one million ultra fine carbon fibre bristles. The cross section of these bristles is so small that they can easily get into all the nooks and crannies of the record groove. Because the carbon fibre conducts electricity, it takes away all the static to earth via the metal handle when holding the brush. After the dust lies loose in the groove, the next set of bristles can easily pick them up and remove them from the groove.

3434 – Tonar Classic Brush (velvet)



The Tonar Classic Brush is manufactured using a very soft long fibre velvet, especially selected for this purpose. The velvet reaches deep into the grooves and removes even the finest dust particles. The brush itself can easily be cleaned using the two foam rubber scrapers located on both sides of the plastic brush base.

4365 – Tonar Dustaway (velvet + carbon fibres)



This state-of-the-art Hi-Fi record cleaning brush combines the properties of the Tonar Classic brush and the Nostatic brush into one brush! The center part of the brush is made of ultra-fine pole high quality velvet. This velvet is flanked on both sides by a thick layer of very fine carbon fibres. The carbon fibres remove the static from the record so the dust comes loose and can be easily picked up by the velvet centre brush even from deep in the grooves. A small tooth-brush is included to easily clean the dust off the velvet after use.

5973 – Tonar Tacky Cleaner (rolling cleaner)



The Tonar Tacky Cleaner is a record cleaner featuring a roll made out of silicone rubber. The property of this rubber is that it is sticky. When rolling the cleaner over the record while applying a little pressure, the rubber will take the shape of the groove and all dust particles in the groove will stick to the rolling cleaner and be removed in that way. When the roll has become dusty simply wash it under tap water using a little hand soap. The dust will easily be rinsed off. After drying the roll with lint free paper, it will become just as sticky as when it was new. There is no danger that you will damage the label when rolling over the label.

4475 – Tonar Nostatic Arm



The Nostatic Arm is the modern version of the formerly well known "Dust Bug" by Cecil Watts. The Nostatic arm incorporates a carbon fibre brush that removes the static charge from the record during playback, and at the same time picks up the loose dust before the stylus reaches that part of the record. The Nostatic arm has an earth wire which is connected to the earth of the record player or the amplifier. The height can easily be adjusted to suit most record players. It also has a sliding weight in order to adjust the "dusting force" of the brush.

4272 – Tonar Dust Jockey (velvet + carbon fibres)



The Tonar Dust Jockey combines the very best ultra-fine pole velvet available on the market with two rows of carbon fibres on both sides of the velvet. The carbon fibres remove the static charge and then the velvet can easily pick up the loose dust from the record. A small tooth-brush is included to easily clean the dust off the velvet after use. This ultimate brush is simply a must for serious vinyl fans and DJs.

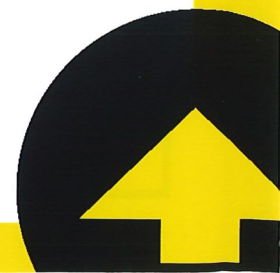

tonar

Vinyl Washing Essentials

Records do not only gather dust. Air pollution from the traffic outside, cooking fat, grease and tobacco smoke causes a tough film to form on the surface of the record. Sometimes even molds and fungi are present if the records have been stored for a prolonged period in a humid environment. The stylus tracking the record will scrape part of this dirt off the groove and this causes a thick build-up of grime on the stylus. Ultimately, this will result in complete miss tracking or groove skipping with permanent damage to your stylus and records. Tonar offers effective solutions to keep your precious record collection impeccable.

5938 – Tonar Wetgoat



When cleaning records with fluid, a special fluid resistant brush is required. The Tonar Wetgoat is made of the finest natural goat hair which has the perfect shape to enter deep into the grooves and clean them thoroughly. Goats hair is known for its ultra-soft qualities, and demonstrable anti-static properties.

5379 – Tonar Woodgoat



The Tonar Woodgoat is a premium record brush that features two rows of real goats hair. Goat hair is used as it is fine, soft and perfect for use when wet, making this brush ideal for any fluid based cleaning liquid you use on your records. The anti-static property of goats hair makes this brush also perfect to clean dusty records without liquid.

5553 – Tonar Top Tip stylus cleaning kit



The Tonar Top Tip is a powerful cleaning solution that will detach all the dirt and tough grime that your stylus collects from the record during playback. The kit contains the Tonar Top Tip cleaning and lubricating liquid and a Tonar Clean-Tip carbon fibre stylus cleaning brush.

4250 – Tonar Clean-Tip (carbon fibre stylus brush only)

QS-Tonar Vinyl Cleaning Fluid

QS-TONAR vinyl cleaning fluid can be used in all record cleaning machines that are currently on the market and is only suitable for vinyl records. Important: do not use with old 78 RPM shellac records as the liquid may do irreparable damage. Now what is so special about the QS-TONAR vinyl cleaner compared to similar looking competing products on the market?

QS-TONAR liquid has an extremely low surface tension

Only because of this reason QS-TONAR liquid can penetrate right to the bottom of the groove. Other fluids

while they seem to penetrate, actually just lie on top of the record surface. Only QS-TONAR liquid cleaner soaks the dust, dirt, air pollution, residue from previously used cleaners, fatty deposits remaining from the original record pressing process, even fungi and moulds caused by records having been stored in humid conditions etc. QS-TONAR liquid detaches all of the before mentioned dirt from the walls of the groove after which the brushes in the machine can easily wipe the groove completely clean. The amount of residue remaining in the groove is negligible – this contrary to other

liquids currently on the market. QS-TONAR liquid is much more volatile than other liquids reducing the drying time of the record to a minimum. QS-TONAR liquid also has another additive causing the dirt to remain floating in the liquid rather than settling back at the bottom of the groove. QS-TONAR liquid is available in three formats: as a 0.5 litre pump spray flask for spraying onto records for small cleaning jobs, as a 1 litre bottle and as a 5 litre tank for big users with washing machines of all types



3514 – QS-Tonar Vinyl cleaner
0.5 Litre pump-spray flask



3503 – QS-Tonar Vinyl cleaner
1 Litre bottle



4262 – QS-Tonar Vinyl cleaner
5 Litre tank

tonar

Tonar *Knosti* Disco-Antistat Vinyl Washing Machines

No matter how much you spend on the complete set-up of your analogue sound system, it is ultimately the vinyl itself that is the source of the sound that you hear from your speakers. Therefore, effective and proper cleaning of your records is vital. The Tonar Knosti Disco-Antistat is a unique manual vinyl washing system that cleans even the dirtiest records and prevents static charges. Every groove of your precious records will be cleaned thoroughly. The Disco-Antistat is easy-to-use and doesn't cost a fortune by comparison with noisy vacuum record cleaning machines.

5412 – Tonar Knosti Disco-Antistat Generation II



The Tonar Knosti Disco-Antistat Generation II is the new and improved manual vinyl washing machine. What are the new features?

NEW: The washing cabinet has practical arms to lock the axis in place. This avoids spilling of the cleaning liquid while rotating the record.

NEW: The included rubber seal in the protective record clamps prevents liquid to reach the label.

NEW: Using the crank-arm, you can easily rotate the record, without getting the cleaning liquid on your hands.



How the Disco-Antistat works:

The Tonar Knosti Disco-Antistat makes it fun and easy to clean your record collection. Each set includes a rectangular washing cabinet, a clamp to protect the label, 1 litre of special vinyl cleaning fluid, a drying rack and a funnel to put the fluid back into the bottle after use.

The washing tub is filled with vinyl cleaning fluid up to the top of the goats hair brushes that are pre-mounted inside.

Next, a dirty record is placed between the two halves of the record clamp and screwed tight. A rubber seal inside the clamp prevents moisture from reaching the label. Protruding from the outer sides of the clamp are two pegs, which sit in slots atop the Tonar Knosti machine. The new Generation II Disco-Antistat includes two arms to lock the record in the slots.

The vinyl is then rotated by hand, or by using the spindle that is included in the Generation II Disco-Antistat. It's recommended to rotate the record 5 to 10 times through the bath in both directions.

As the record passes through the washing tub, two sets of brushes clean each side of the record. The brushes are made using the finest natural goats hair, which has the unique property to enter deep into the grooves and the hair is not attacked by the fluid.

Once you're happy with the result, simply remove the record from the protective clamps, and place your clean record on the rack to dry. When cleaning is complete, pour your used cleaning fluid from the washing tub back into your cleaning fluid bottle for re-use using the funnel and filter provided.

A regular washing of your records at least once a year can increase your listening pleasure dramatically.

3508 – Tonar Knosti Disco-Antistat

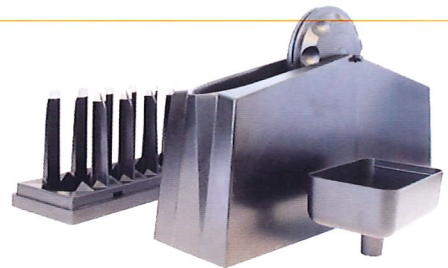

The Tonar Knosti Disco-Antistat is the classic manual vinyl washing machine as successfully produced since 1978.

The Disco-Antistat set includes:

- Washing cabinet with integrated brushes made out of goats hair.
- Label protecting clamshell with axis for 12 inch LPs, 10 inch Long Play records and 7 inch 45 RPM Singles and EP records.
- A funnel with filters is provided to allow re-use of your cleaning fluid if desired.
- Drip-dry rack with catch basin for up to 15 records of any size.
- 1 liter Knosti anti-static cleaning fluid

New records as well as old ones from the attic..

The Disco-Antistat makes them clean and anti-static!



vinyl washing machines

tonar

Record Sleeves

Protect your fragile vinyl records and record albums from dust, air pollution, tobacco smoke, fungi and other contaminants with Tonar anti-static record sleeves



record sleeves



tonar

Record Sleeves

Dust and air pollution are the biggest enemies of your fragile vinyl records and your record album covers. Pollution from cooking grease, smoking and outside pollution (like exhaust fumes from cars) causes a sticky aggressive film to build up on your records. This sticky film attracts and grabs even more dust and spoils the sound on playback. It is very important to protect your vinyl and keep your records clean. Good quality anti-static dust free record inner sleeves and sturdy outer sleeves will protect your records and albums from these influences.

Tonar Inner Sleeves

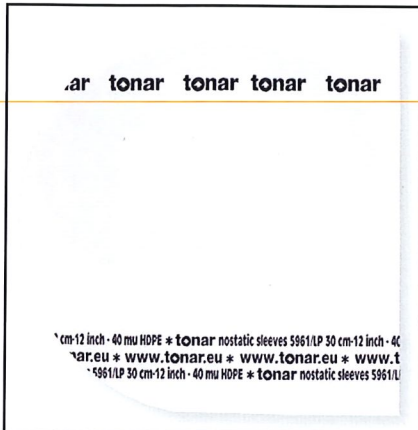

Tonar Plastipap

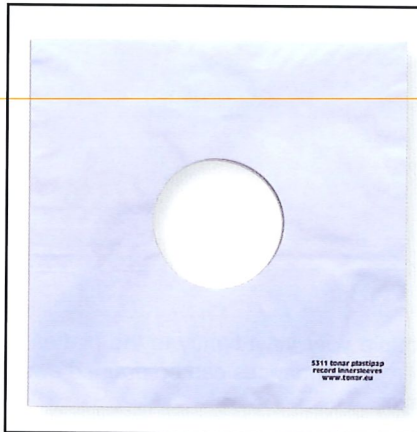

Tonar Outer Sleeves

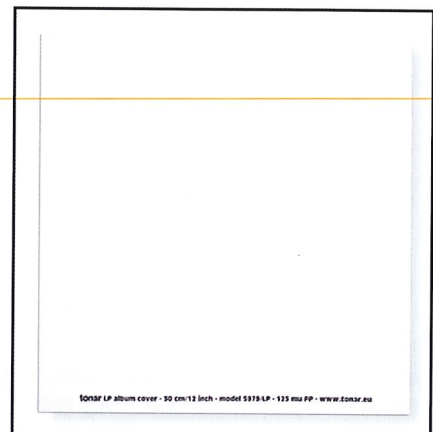

The Tonar Nostatic Inner Sleeves are made of 2 layers 40 micron thick HDPE super anti-static plastic. The Nostatic sleeves are available in three sizes: 12 inch, 10 inch and 7 inch. So there is a Tonar Nostatic sleeve available for every format whether 12 inch LP, 10 inch Long play and 78 RPM Shellac and 7 inch 45 RPM and EP records.

Tonar's best solution is the already world famous 'Plastipap inner sleeve'. This very strong sleeve consists of 4 layers with 40 micron thick HDPE super anti-static plastic and two layers of 100% sealed paper reinforcements in between. This product is currently only available for 12 inch LP records.

Your valuable record albums will easily get soiled due to air pollution and handling with (greasy) fingers. Use the Tonar heavy duty outer sleeves made from Crystal Clear 125 micron thick PP plastic. The Tonar outer sleeves are also available in three sizes for 12 inch LP, 10 inch Long play or 78 RPM Shellac and 7 inch 45 RPM or EP records.

available sizes

12 inch

5961 – Tonar Nostatic sleeves for 12 inch (30cm) LP records (50 sleeves per package).

10 inch

5315 – Tonar Nostatic sleeves for 10 inch Long Play records as well as 78 RPM shellac records. Contains 25 sleeves per package.

7 inch

5983 – Tonar Nostatic sleeves for 7 inch (17.8 cm) 45 RPM records. Contains 50 sleeves per package.

available sizes

12 inch

5979 – Tonar 12 inch heavy duty outer sleeves for LP records. Contains 25 sleeves per package.

10 inch

5313 – Tonar 10 inch heavy duty outer sleeves for LP records as well as 78 RPM shellac records. Contains 25 sleeves per package.

7 inch

5317 – Tonar 7 inch heavy duty outer sleeves for 45 RPM records. Contains 50 sleeves per package.

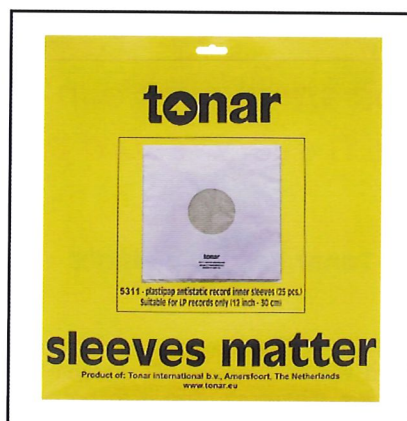
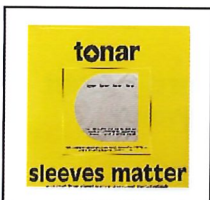

5311 – Tonar Plastipap inner sleeves
Contains 25 pieces per package.

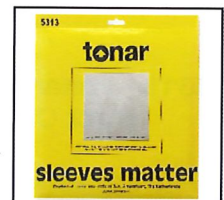

*The best solution to store and preserve
your record collection*

visit our website: www.tonar.eu

Record Sleeves

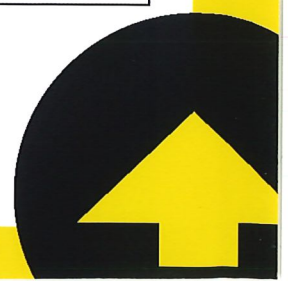

tonar

Record Weights and Clamps

There are two distinct advantages to using a record clamp or weight on your turntable. First, they help to temporarily flatten warped records during playback. Many of the older records are either warped from the time they were pressed or have become warped in time due to bad storage. A warped record causes enormous problems for the cartridge and stylus to track the groove properly. Secondly, vinyl records vibrate along with the music as the stylus traces the groove. This can cause internal resonances. By using a record clamp or a weight, warped records will be flattened and the sound quality will be improved.

5464 – Tonar misty clear clamp



5290 – Tonar misty yellow clamp



5470 – Tonar misty black clamp



The aesthetically designed Tonar clamps couple your vinyl tightly to the platter. This will help to temporarily flatten out any warps during play-back and assures that internal resonances can be drained away from the stylus. The clamps are available in different colors, to match every record player.

5478 – Tonar misty green clamp



5475 – Tonar misty red clamp



5467 – Tonar misty blue clamp



*The Tonar clamps are available in different colors,
to match every record player*

4611 – Tonar Record Weight
Black (760 grams)



Tonar Record Weights

By using a Tonar record weight, the record will be pressed flat against the turntable platter causing it to become temporarily less warped during playback and making good contact with the platter. The weights are either nickle colour or covered with black enamel and a felt cushion on the base to protect the label of the record against scratching. Dimensions: 78 mm diameter x 25 mm. Caution: Please ensure that the platter bearing of your turntable is able to accept the additional weight of 760 grams. If in any doubt please consult your record player instructions or your dealer.

5964 – Tonar Record Weight
Nickle (760 grams)



tonar

Turntable Mats

Acoustic feedback is one of the big problems when playing records. It occurs when sound vibrations from your loud speakers are picked up by your turntable, amplified, and then sent out to the speakers again. The same information is reproduced by the cartridge with a very slight time difference. This results in a big loss of detail and clarity and makes the sound 'muddy'. Tonar has developed turntable mats that reduce acoustic feedback, thus maintaining separation and detail. The mats isolate the record from the turntable platter and absorb unwanted vibrations. That is why using turntable mats really matters!

Tonar Turntable Mats

Turntable Mats Matter!

The Tonar turntable mats have been developed through experiments with different materials. Apart from absorbing and dampening unwanted vibrations, the mats have their own effect to enhance the sound. Some audiophiles even combine different materials as a 'sandwich' to create even better results.

Tonar offers a large selection of commercially manufactured mats made from various materials for you to be able to experiment yourself and to find the best mat for the different recordings in your collection. All Tonar mats (except the Nostatic Mat and the Leather Mat) have a depressed centre section, allowing space for the thicker record label so the vinyl record can lay perfectly flat on the mat. All mats have a diameter of 295 mm, except for the Rubber Mat (diameter: 298 mm). Now start testing your own combination of mats to fit your musical taste and improve the quality of the sound!

5391 – Tonar Crystal Mat

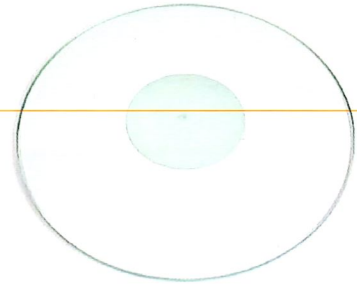

This luxury mat is made of pure glass and enhances the detail of the various instruments or vocals on your records. It is lighter and harder than aluminium, and produces a crystal clear sound.

5972 – Tonar Pure Cork turntable mat



Cork material is known to dampen and absorb unwanted vibrations. The Tonar cork mat works very well on most turntables, due to its non-resonant properties.

5312 – Tonar Nostatic Mat II Improved

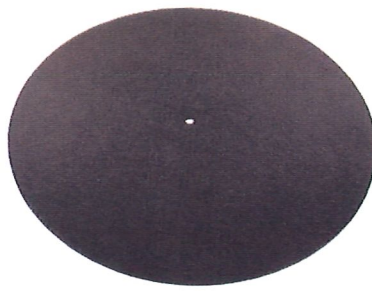

The Tonar Nostatic mat is a mat made of industrial felt mixed with carbon fibres. The carbon fibres release the static charge from the record and conduct it to earth using the metal spindle of the record player.

5974 – Tonar Cork & Rubber mixture turntable mat



Both cork and rubber are known to dampen and absorb unwanted vibrations. The Tonar composite cork/rubber mat works very well on many turntables, particularly on steel and lightweight turntable platters, due to its highly non-resonant properties.

5978 – Tonar Black Natural leather turntable mat



The Tonar Black Leather Platter Mat is a premium mat made from real leather/suede. With its luxury look, this leather mat dampens and absorbs unwanted vibrations.

5976 – Tonar Pure White Perspex mat



Perspex is a kind of acrylic. The mat enhances in particular the higher frequencies. Also in terms of aesthetics, this white coloured mat can perfectly match your modern turntable.

5988 – Tonar Rubber turntable mat



Sometimes, the original rubber mat on the turnplayer has become dirty or even has chemically decomposed. Tonar offers a fresh new rubber turntable mat to replace the old one.

turntable mats



tonar

Turntable Essentials

Everyone who puts on a vinyl record, will soon realize that a turntable is actually an engineering work of art and a musical instrument itself. Perhaps it is the beauty of analogue audio, that as a user, you have almost every possibility to fully fine-tune your equipment. Tonar offers various affordable tools that are not only effective, but also easy-to-use and will benefit your listening pleasure.

5944 – The Q UP automatic tonearm lifter

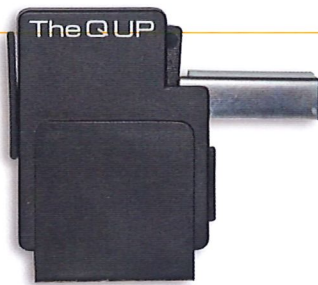

Using the Q UP tonearm lifter, extends the life of your stylus

The Q UP is a high precision device that safely lifts your tonearm at the end of the record. This will extend the life of your stylus significantly. The Q UP can be installed in minutes, without tools, and is designed to fit on most manual turntables. The Q UP can be configured for a variety of tonearm heights, thicknesses and shapes. This unique automatic tonearm lifter only interacts with the tonearm at the end of record and does not adversely effect the tonal quality of your system in any way. Thanks to the Q UP, you don't need to worry about getting distracted or falling asleep while you play your records.



5462 – Tonar Ecolevel Yellow



Tonar Turntable Levels

For the best sound reproduction your turntable has to be installed precisely horizontal. These simple but effective levels from Tonar will tell you if your turntable is mounted on a flat surface for optimal performance.

5469 – Tonar Luxlevel Black

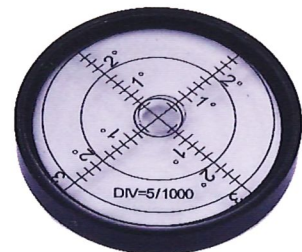

4189 – Tonar Vinyline MC/MM Pre-Amplifier



The Tonar Vinyline phono MM/MC Pre-Amplifier is a very affordable solution to connect High End phonograph cartridges whether moving magnet (MM) or moving coil (MC) to the AUX port of your amplifier. A switch on the back switches it from high output MM to low output MC mode.

Specifications:

Input (MM):	47 K Ω / 100 p.Farad
Input (MC):	100 Ω / 100 p.Farad
Output MM:	200 mV/1 KHz at 5mV/1KHz MM
Output MC:	200 mV/1 KHz at 0.45 mV/1KHz MC
Gain:	MM: 32 dB / MC: 53 dB
Noise floor:	MM: -88 dB / MC: -79 dB
THD:	0.005%
RIAA curve acc.:	20 – 20.000 Hz / max: 0.5 dB
Power supply:	16V/200 mA AC



tonar

Turtable Essentials

Tonar Trackurate digital stylus force gauge



4293 – Tonar Trackurate (yellow)



3583 – Tonar Professional alignment protractor

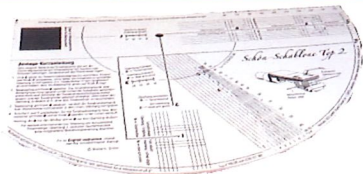

This Protractor is a unique alignment gauge which allows you to check the tone arm geometry and to install the cartridge ideally aligned to keep distortion to a minimum. It offers every essential information in order to install and align your cartridge professionally. English and German instructions included. A must for the very serious Hi-Fi enthusiast.

3193 – Tonar No Rumble Pads



These pads, supplied in sets of 8 pieces, isolate your audio equipment from vibrations in the room. For turntables, speakers, and any other delicate systems. The No Rumble Pads are an effective solution for reducing rumble and vibration at the source before it passes through your system.

Getting the most out of any turntable requires an accurate vertical tracking force setting. Every cartridge on the market has a preferred tracking force range recommended by the manufacturer. Depending on the arm used you may have to be lower in the range or higher in the range. The Tonar Trackurate helps you adjust the tracking force very accurately. The easy to use Tonar Trackurate is the one case where digital makes more sense when it comes to fine-tuning your analog.

The Tonar Trackurate includes a soft case, batteries (AG12 button cell) and a weight to calibrate.



4367 – Tonar Trackurate (black)

Specifications:

Capacity: 0 - 5 grams

Accuracy: 0.01 grams

Weighing modes: g; oz; ozt; TL; ct

4208 – Tonar simple alignment protractor



A proper alignment of your cartridge will help you to enjoy the best possible sound. The Tonar Simple Alignment Protractor is an inexpensive device that allows you to properly mount and adjust your cartridge stylus for optimal groove tracking and music retrieval. The mirror makes it easy to check the azimuth of the cantilever.

5953 – Tonar 45 RPM adapter aluminum



The Tonar 45-rpm adapter is made of solid aluminum and is perfectly centered so you can optimally enjoy your favorite singles. It fits all modern turntables and can also be used on older turntables.

4614 – Tonar Anti-Skate Weight



Using an Anti-Skate Weight helps to bring a perfect amount of counter-drag on the tonearm, reducing the inclination for the arm to 'skip' or 'skate' across the record.

Tonar Turntable Belts

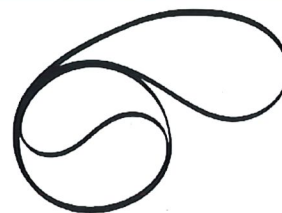

Worn and stretched belts are the largest contributor to turntable speed fluctuations which destroy your sound-stage. Tonar can supply replacement belts for almost any brand and model turntable.



tonar

Stroboscope Discs

Records over the years have been cut at many different speeds. Originally they were cut at '78 RPM' or speeds around that value. Later the industry decided to cut all records at 33 1/3 or 45 RPM. For speech recordings even slower speeds were used in order to increase the amount of time recorded on each side of the record: 16 2/3 and 8 1/3 RPM. Of course you want to enjoy a recording at the correct tempo, but sometimes record players do not play at the proper speed and need adjusting. For that purpose Tonar now offers a total of three different Stroboscope Discs.

The detailed and easy-to-use Tonar Stroboscope Discs are created in three versions to measure different ranges of speed:

- A simple Tonar part 5468 Aluminium stroboscope disc of 10 cm diameter with the speeds 8 1/3, 16 2/3, 33 1/3, 45 and 78 RPM.
- For more accurate use we also offer Tonar part 5463 12 inch yellow acrylic stroboscope also with the speeds 8 1/3, 16 2/3, 33 1/3, 45 and 78 RPM.
- Finally for the 78 RPM shellac record collector we offer a very special Tonar part 5466 – 12 inch yellow acrylic Stroboscope disc offering all speeds: 8 1/3; 16 2/3; 33 1/3; 45; 70; 72; 73; 75; 76; 78; 80; 81; 83; 85; 87; 90 RPM. The reason for this is that in the beginning of the record industry every record manufacturer recorded at their own speed. This is apparent from the old Pathé phones which even had a speed control. As modern players offer a strict 78 RPM speed many of the really old shellac records sound odd because they are playing at either a too slow speed (tones are too low) or a too fast speed (tones are too high).

Enjoy your records at the proper speed

How to use the Tonar Stroboscope Discs

If you have a record player with pitch (speed) control like a DJ-record player you can adjust the speed. Put the record on the player at 78 RPM and listen, then adjust the speed up or down until the record sounds normal. Then replace the record with the Stroboscope and read the speed that you selected and make a note of this on the album. Next time you want to play the record, first put the stroboscope to adjust to the proper speed setting and then play the record immediately at the proper speed.

5463 – Stroboscope 30 cm diameter Deluxe

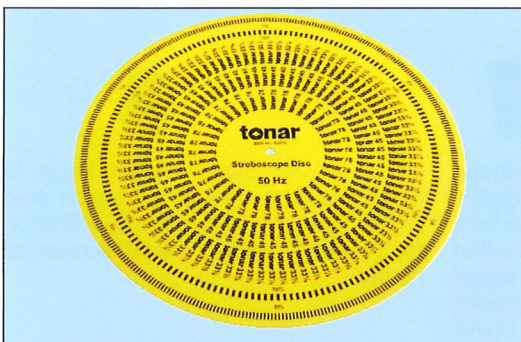

Speeds: 8 1/3; 16 2/3; 33 1/3; 45; 78 RPM.

5466 – 12 inch Yellow Acrylic Stroboscope Disc for all speeds

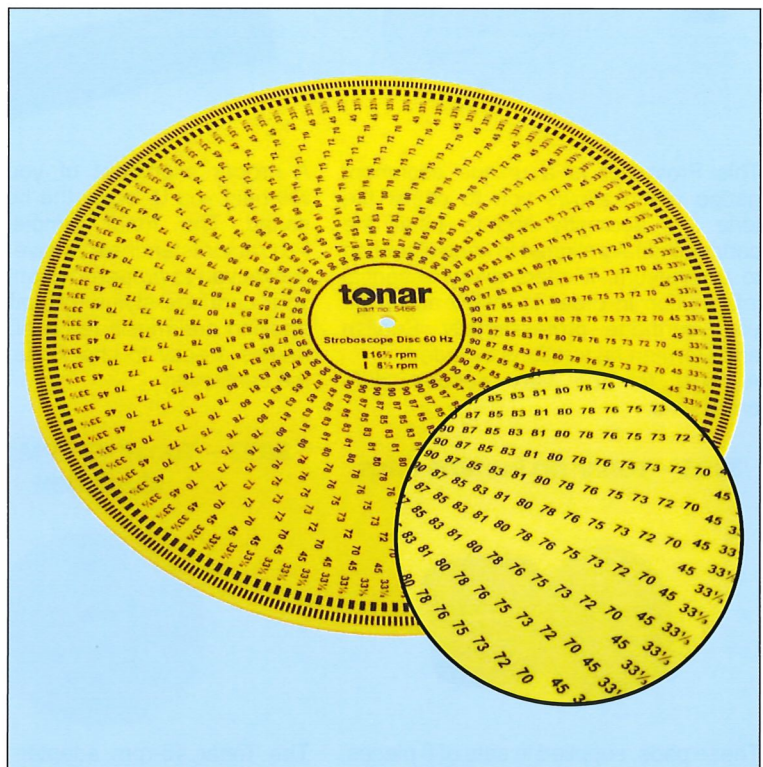

This Tonar Stroboscope Disc offers all speeds: 8 1/3; 16 2/3; 33 1/3; 45; 70; 72; 73; 75; 76; 78; 80; 81; 83; 85; 87; 90 RPM. The ultimate stroboscope disc for the 78 RPM shellac record collector!

5468 – Aluminium Stroboscope 10 cm diameter Standard

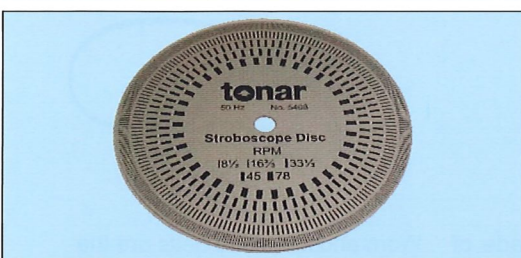

Speeds: 8 1/3; 16 2/3; 33 1/3; 45; 78 RPM.

Tonar Stroboscopes, a must for every record collector!

stroboscope discs

tonar

High End Head Shells and Wiring

Most turntables are supplied with a standard entry level head shell. The sound quality can be strongly improved by using a so-called "high end shell". Some shells have the possibility to adjust the pitch of the shell axial wise, as compared to the tone arm. This allows an exact vertical mounting of the cartridge and stylus tip onto the record. Further improvements can be made by using high quality head shell lead wires.

Tonar TopQ High End head shells

Tonar TopQ High End head shells come in two versions, one with a removable arm lifter and one with a fixed arm lifter. Both models have the possibility to adjust the pitch of the shell axial wise, as compared to the tone arm. This allows an exact vertical mounting of the cartridge and stylus tip onto the record. The finest quality OFC (Oxygen Free Copper) lead wires are used in the Tonar TopQ head shells. Both models are available in black or in silver/bronze. All Tonar TopQ models have a SME type connector for use on S-shaped tone arms.



4420 – Tonar TopQ head shell (black) removable arm lifter



5330 – Tonar TopQ head shell (black) fixed arm lifter



5907 – Tonar TopQ head shell (silver/bronze) removable arm lifter



5386 – Tonar TopQ head shell (silver/bronze) fixed arm lifter

Tonar SME type High End head shells

Light weight entry level shells suitable for most tone arms with SME type connector.



3197 – Tonar SME type shell (black)



3196 – Tonar SME type shell (silver)

5405 – Tonar Cherry Wood head shell



The Tonar head shell made of cherry wood, is a high quality audiophile head shell and provides an elegant solution with a variety of cartridges. It has a SME style locking collar (as found on most tone arms with removable head shells). The connectors are gold plated and the included head shell leads are silver plated.

5970 – Tonar Shell wire CU-litz (OFC copper)



Our finest Oxygen Free Copper (OFC) head shell wires with gold plated clips as used in the Tonar TopQ shells.

Lenco Head Shell 5407 (silver) – 5408 (black)

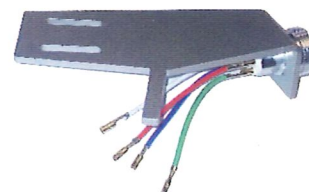

There are many vintage Lenco record players on the market that only require a head shell. The original shell is no longer available, but now there is a high quality Tonar replacement model. Fits Lenco players B52; B55; L72; L75, L76 and L78. Includes a set of mounting plates.



4612 – Tonar High End Tone arm wires sets

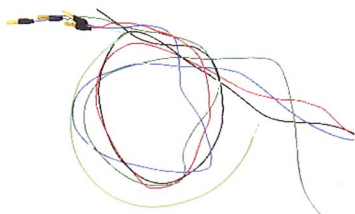

The Tonar tone arm wire sets are made of 99.99% Oxygen free copper and are available in a length of 53 cm with gold plated terminal pin lugs on one side.

4613 – Tonar Gold Plate terminal pins for cartridges



The gold plated pins enhance a low resistance electrical connection with the wires, because they cannot oxidize.

high end head shells and wiring

tonar

HiFi Cartridges 1/2 Inch Mounting

Tonar Flip Series Cartridges 1/2 Inch Mounting

The cartridge is perhaps the most important component of your whole audio system. The cartridge converts the vibrations of the stylus into audio signals, which are amplified in the rest of your system. Hence, the cartridge determines largely the quality of the sound that you hear. What doesn't go in, doesn't come out. For that matter, selecting a cartridge is vital for your listening pleasure.

In order to provide excellent sound reproduction at a modest price, Tonar has launched the Tonar Flip-series of cartridges with high end models available to suit all budgets. The Tonar 1/2 inch standard mount Flip cartridges are now also available with a hyper-elliptical or with a Shibata stylus tip. These cartridges offer excellent sound reproduction in the higher frequency ranges. The use of the Shibata tip also reduces record and stylus wear to the absolute minimum.

9511 – Tonar C - Flip Spherical tip



Output	3.5 mV at 1 KHz 5.0 cm/sec
Channel balance	within 2.5 dB at 1 KHz
Channel separation	more than 18 dB at 1 KHz
Load impedance	47 KΩ
Load capacitance	100 pF
Static compliance	12 x 10 ⁻⁶ cm/dyne
Dynamic compliance	5 x 10 ⁻⁶ cm/dyne
Tracking force	1.5 – 2.5 gram (opt. 2.0 gr.)
Stylus tip radius	0.6 mil spherical
Stylus tip material	bonded diamond
Tip diameter	0.3 mm
Cantilever	carbon fibre
Cartridge weight	5.0 grams ± 0.5 gr.
Frequency response	20 – 20,000 Hz. ± 3 dB

9513 – Tonar E - Flip Elliptical tip



Output	3.5 mV at 1 KHz 5.0 cm/sec
Channel balance	within 2.5 dB at 1 KHz
Channel separation	more than 18 dB at 1 KHz
Load impedance	47 KΩ
Load capacitance	100 pF
Static compliance	12 x 10 ⁻⁶ cm/dyne
Dynamic compliance	5 x 10 ⁻⁶ cm/dyne
Tracking force	1.5 – 2.5 gram (opt. 2.0 gr.)
Stylus tip radius	0.3 x 0.7 mil elliptical
Stylus tip material	bonded diamond
Tip diameter	0.3 mm
Cantilever	aluminium
Cartridge weight	5.0 grams ± 0.5 gr.
Frequency response	20 – 20,000 Hz. ± 3 dB

9583 – Tonar H - Flip Hyper Elliptical tip



Output	3.5 mV at 1 KHz 5.0 cm/sec
Channel balance	within 1.5 dB at 1 KHz
Channel separation	more than 22 dB at 1 KHz
Load impedance	47 KΩ
Load capacitance	100 pF
Static compliance	12 x 10 ⁻⁶ cm/dyne
Dynamic compliance	5 x 10 ⁻⁶ cm/dyne
Tracking force	1.5 – 2.0 gram (opt. 1.75 gr.)
Stylus tip radius	0.2 x 0.7 mil hyper elliptical
Stylus tip material	bonded diamond
Tip diameter	0.25 mm
Cantilever	aluminium pipe
Cartridge weight	5.0 grams ± 0.5 gr.
Frequency response	15 – 25,000 Hz. ± 2.5 dB

9586 – Tonar S - Flip Shibata tip



Output	3.5 mV at 1 KHz 5.0 cm/sec
Channel balance	within 1.5 dB at 1 KHz
Channel separation	more than 28 dB at 1 KHz
Load impedance	47 KΩ
Load capacitance	100 pF
Static compliance	12 x 10 ⁻⁶ cm/dyne
Dynamic compliance	5 x 10 ⁻⁶ cm/dyne
Tracking force	1.5 – 2.0 gram (opt. 1.50 gr.)
Stylus tip radius	shibata - line contact
Stylus tip material	bonded diamond
Tip diameter	0.25 mm
Cantilever	aluminium pipe
Cartridge weight	5.0 grams ± 0.5 gr.
Frequency response	15 – 30,000 Hz. ± 2.5 dB

HiFi Cartridges T4P (Plug-In) Mounting

Tonar Plugger Series Cartridges T4P (Plug-In) Mounting

Once, T4P (plug in) was a very popular option for easily mounting and changing cartridges. The record players using this mounting standard have become more rare. Because of that, most cartridge manufacturers have discontinued producing T4P-type plug-in cartridges. Now Tonar has launched the Tonar Plugger series of T4P plug-in cartridges with high end models available again to suit all budgets. These T4P cartridges provide excellent sound reproduction at a modest price.

Very few cartridge manufacturers offer T4P cartridges with Hyper-Elliptical and/or Shibata tips. Tonar is happy to provide these models. These Tonar Plugger cartridges offer excellent sound reproduction in the higher frequency ranges. The use of the Shibata tip also reduces record and stylus wear to the absolute minimum.

9496 – Tonar C - Plugger Spherical tip



Output	5.0 mV at 1 KHz 5.0 cm/sec
Channel balance	within 1.5 dB at 1 KHz
Channel separation	more than 24 dB at 1 KHz
Load impedance	47 KΩ
Load capacitance	100 pF
Static compliance	12 x 10 ⁻⁶ cm/dyne
Dynamic compliance	5 x 10 ⁻⁶ cm/dyne
Tracking force	1.5 – 2.0 gram (opt. 1.75 gr.)
Stylus tip radius	0.6 mil spherical
Stylus tip material	bonded diamond
Tip diameter	0.3 mm
Cantilever	carbon fibre
Cartridge weight	5.0 grams ± 0.5 gr.
Frequency response	0 – 20,000 Hz. ± 2.5 dB

9540 – Tonar E - Plugger Elliptical tip



Output	5.0 mV at 1 KHz 5.0 cm/sec
Channel balance	within 1.5 dB at 1 KHz
Channel separation	more than 24 dB at 1 KHz
Load impedance	47 KΩ
Load capacitance	100 pF
Static compliance	12 x 10 ⁻⁶ cm/dyne
Dynamic compliance	5 x 10 ⁻⁶ cm/dyne
Tracking force	1.0 – 1.5 gram (opt. 1.50 gr.)
Stylus tip radius	0.3 x 0.7 mil elliptical
Stylus tip material	bonded diamond
Tip diameter	0.3 mm
Cantilever	aluminium pipe
Cartridge weight	5.0 grams ± 0.5 gr.
Frequency response	20 – 23,000 Hz. ± 2.5 dB

9588 – Tonar H - Plugger Hyper Elliptical tip



Output	5.0 mV at 1 KHz 5.0 cm/sec
Channel balance	within 1.5 dB at 1 KHz
Channel separation	more than 26 dB at 1 KHz
Load impedance	47 KΩ
Load capacitance	100 pF
Static compliance	12 x 10 ⁻⁶ cm/dyne
Dynamic compliance	5 x 10 ⁻⁶ cm/dyne
Tracking force	1.0 – 1.5 gram (opt. 1.50 gr.)
Stylus tip radius	0.2 x 0.7 mil hyper elliptical
Stylus tip material	bonded diamond
Tip diameter	0.25 mm
Cantilever	aluminium pipe
Cartridge weight	5.0 grams ± 0.5 gr.
Frequency response	15 – 25,000 Hz. ± 2.5 dB

9590 – Tonar S - Plugger Shibata tip



Output	5.0 mV at 1 KHz 5.0 cm/sec
Channel balance	within 1.5 dB at 1 KHz
Channel separation	more than 28 dB at 1 KHz
Load impedance	47 KΩ
Load capacitance	100 pF
Static compliance	12 x 10 ⁻⁶ cm/dyne
Dynamic compliance	5 x 10 ⁻⁶ cm/dyne
Tracking force	1.0 – 1.5 gram (opt. 1.50 gr.)
Stylus tip radius	shibata - line contact
Stylus tip material	bonded diamond
Tip diameter	0.25 mm
Cantilever	aluminium pipe
Cartridge weight	5.0 grams ± 0.5 gr.
Frequency response	15 – 30,000 Hz. ± 2.5 dB

tonar

DJ Cartridges and Head Shells

2994 – Tonar Birdie DJ cartridge

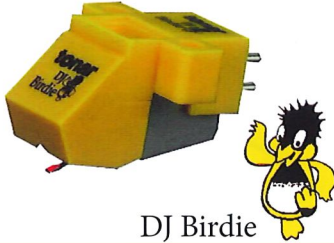

DJ Birdie

The Tonar DJ Birdie is a great DJ cartridge at a modest price. The fluorescent tip makes it easy for the DJ to put the stylus in the desired part of the groove. Many jukebox collectors have also discovered this cartridge to replace their no-longer available original jukebox cartridges.

Cartridge weight	4.1 g
Stylus tip shape/radius	0.7 mil spherical diamond
Frequency characteristics	20-20,000 Hz +/- 4 dB
Output Voltage	5.0 mV (5 cm/sec)
Channel Separation	17 dB (1 KHz)
Channel balance	2.0 dB or less (1 KHz)
Compliance	3.5×10^{-6} cm/dyne
Stylus pressure	2.0 – 3.0 g (2.5 g opt.)
Load resistance	47 K Ω
Stylus tip material	bonded diamond
Tip diameter	0.4 mm
Vertical tracking angle	20°
Recommended load resistance	47 k Ω
Recommended load capacitance	400 pF
Scratching	suitable for scratching
Cartridge mounting system	½ inch

2735 – Tonar Banana DJ cartridge



Banana

The Banana is Tonar's legendary yellow DJ cartridge, designed to meet the high demands of DJs. Its integrated design connecting directly to the SME-type tonearm connector, makes it very easy for the DJ to mount his cartridges on tour. The Tonar Banana provides the essential vitamins for your audience.

Cartridge weight	16.0 g
Stylus tip shape/radius	0.7 mil spherical diamond
Frequency characteristics	20-20,000 Hz
Output Voltage	5.0 mV (5 cm/sec)
Channel Separation	20 dB (1 KHz)
Channel balance	2.0 dB or less (1 KHz)
Dynamic compliance	8 μ m/mN
Load resistance	3.0 – 5.0 g (4.0 g opt.)
Stylus pressure	47 K Ω
Stylus tip material	bonded diamond
Vertical tracking angle	20°
FIM distortion	1.8%
DC resistance	600 Ω
Recommended load resistance	47 k Ω
Recommended load capacitance	400 pF
Scratching	suitable for scratching
Cartridge mounting system	for SME-type arm only
Tracking ability at 315 Hz lateral	70 μ m

2987 – Tonar Diabolic - E DJ cartridge



Diabolic E

The devil is in the detail! With its unique 8 millivolt output, the Diabolic-E is full of DJ power. Many audiophiles favour the Diabolic-E thanks to its sound quality and elliptical diamond stylus.

Cartridge weight	5.0 g
Stylus tip shape/radius	elliptical diamond
Frequency characteristics	20-24,000 Hz +/- 4 dB
Output Voltage	8.0 mV (5 cm/sec)
Channel Separation	18 dB (1 KHz)
Channel balance	2.0 dB or less (1 KHz)
Compliance	6.0×10^{-6} cm/dyne
Stylus pressure	4.0 – 5.0 g (4.5 g opt.)
Load resistance	47 K Ω
Stylus tip material	bonded diamond
Tip diameter	0.3 mm
Vertical tracking angle	20°
Recommended load resistance	47 k Ω
Recommended load capacitance	400 pF
Scratching	suitable for scratching
Cartridge mounting system	½ inch

Tonar DJ head shells



4601 – Tonar DJ head shell (silver)

4602 – Tonar DJ head shell (black)

4603 – Tonar DJ head shell (silver)

4604 – Tonar DJ head shell (black)

The best selling DJ head shells and general purpose shells. Made of high quality aluminum. For DJs that require a heavier tracking force, the head shells 4603 and 4604 also include a 2 gram and a 4 gram additional screw-on weight.

DJ cartridges and head shells



tonar

specialist in styli, cartridges and accessories for vinyl
www.tonar.eu

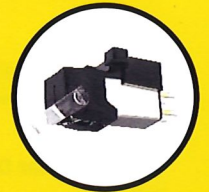

Your Tonar dealer:

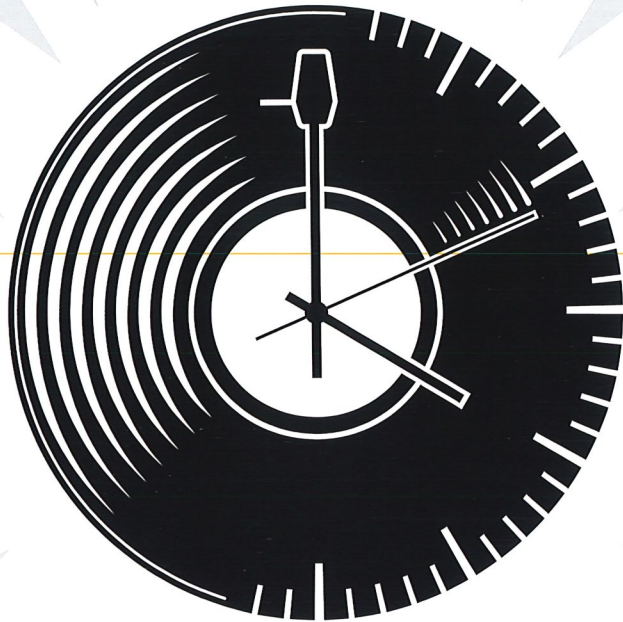

StylusTimer™

Keeps track of the playing time of your stylus

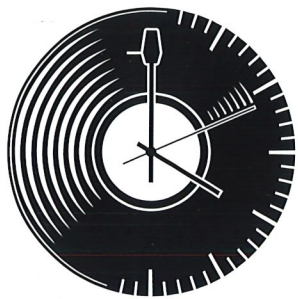

StylusTimer™



€ 24,95

Tonar no. 5241

BESCHERM UW PLATEN | HOUD UW GEBRUIKSTIJD BIJ | ZIE WANNEER UW NAALD MOET WORDEN VERVANGEN

- Nu kunt U eenvoudig het aantal luisteruren van Uw naald bijhouden.
- Bepaal nauwkeurig de inspeeltijd van Uw naald
- Bescherm Uw dierbare platencollectie tegen schade door een versleten naald
- Weet op tijd wanneer Uw naald vervangen dient te worden
- Haal het maximale uit de aanschaf van Uw element, vooral de duurdere High End elementen
- Houd Uw luistertijd bij en zie de teller oplopen terwijl U geniet van Uw favoriete muziek



FEITEN & FEATURES

De naald (stylus) van Uw element (cartridge) dient na 1000 uur afspeeltijd (soms nog eerder) vervangen te worden. Een versleten naald vermindert de geluidskwaliteit en kan schade toebrengen aan Uw waardevolle platencollectie. Helaas hebben veel vinyl-liefhebbers geen idee hoeveel uren de naald is gebruikt, terwijl er maanden en soms jaren voorbijgaan.

Met de StylusTimer kunt U nauwkeurig Uw afspeeltijd bijhouden. De StylusTimer is een unieke chronograaf, speciaal ontworpen voor platenspelers. Voor slechts € 24,95 is de StylusTimer een must-have gadget voor elke vinyl-liefhebber.

De StylusTimer, voorzien van een roestvrijstalen behuizing, staat mooi bij elke platenspeler. Zonder een StylusTimer is Uw platenspeler incompleet.

*Batterij (AAA-type) niet inbegrepen. Tijdsmeting blijft behouden tijdens de batterijwissel.

StylusTimer wordt gedistribueerd in Europa door Tonar International.

Tonar International B.V. - Beeldschermweg 5 unit I - 3821 AH Amersfoort - Nederland

Telefoon : +31 33 - 455 45 11 - Fax : +31 33 - 456 05 44 - E-mail : info@tonar.eu - www.tonar.eu

StylusTimer is ontworpen door Sound Advice columnist Don Lindich. V.S. & Internationaal patent aangevraagd.

— www.stylustimer.com —

disco-antistat

bewährt seit 1978! • proven since 1978!
épreuve depuis 1978! • iacreditado desde 1978!
sperimentato dall'anno 1978!

made in Germany

DISCO-ANTISTAT
Art. Nr. 1 3000 01



STEREO Test 1/2008: "...ist die unschlagbar günstige und **seit über 30 Jahren** unverändert angebotene Maschine **ein ganz heißer Tipp**."
STEREO Test 1/2008: "...this machine, which comes for an unbeatable price, unchanged **for more than 30 years, is a very hot tip.**"

Schallplatten-Waschgerät

Reinigt schonend rillentief und verhindert dauerhaft statische Aufladungen. Die optimale Schallplattenpflege für ungestörten Musikgenuss.

Record-cleaning-kit

Each groove is thoroughly cleaned and will remain static free. The best method of record cleaning essential for maximum listening enjoyment.

Lave disque

Nettoie, avec précaution, en profondeur du sillon et évite, à long terme, les charges statiques. L'entretien idéal, permettant de goûter sans troubles les plaisirs de la musique.

Macchina lavadischi

La pulizia è dolce ed evita le cariche elettrostatiche per lungo tempo. E' una pulizia perfetta per godersi la musica senza disturbi.

Aparato limpiador

Limpia profunda y delicadamente los surcos y evita las cargas estáticas de forma duradera. El cuidado ideal para los discos de vinilo que te permitirá disfrutar de la música sin interferencias.



disco-antistat

bewährt seit 1978! • proven since 1978!
 éprouvée depuis 1978! • iacreditado desde 1978!
 sperimentato dall'anno 1978!

made in Germany

DISCO-ANTISTAT
 Art. Nr. 1 3000 01

DISCO-ANTISTAT-MIXTURE
 Art. Nr. 1 3010 00

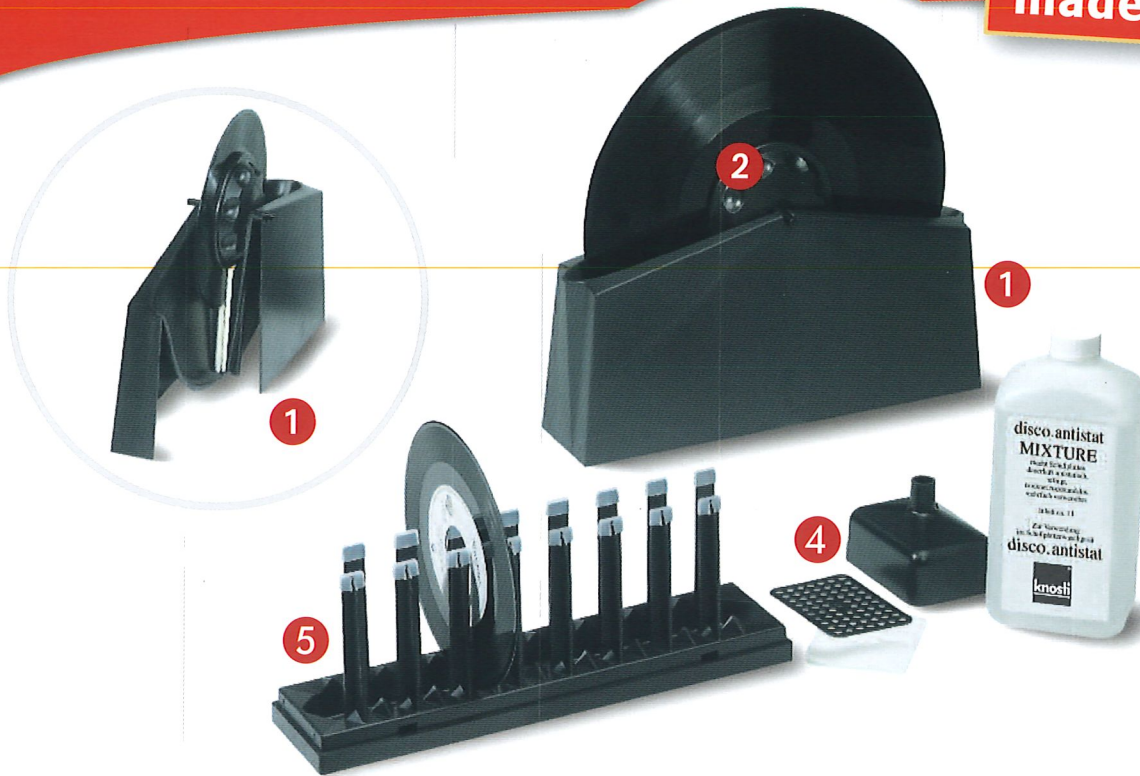

- 1 Waschgehäuse mit eingesetzten Borsten aus Ziegenhaar.
- 2 Label-Dichtschalen mit Aufhängeachse für Singles und LPs.
- 3 Flasche mit 1L Reinigungsflüssigkeit DISCO-ANTISTAT-MIXTURE. Mehrfach verwendbar.
- 4 Trichter, mit dem die Flüssigkeit nach Gebrauch aus dem Waschgehäuse wieder in die Flasche zurückgefüllt wird.
- 5 Abtropfständer mit Auffangschale für 15 LPs oder Singles. Er wird nach Gebrauch in das Gehäuse eingeschoben.

- 1 Record bath with integral brush of soft goats hair.
- 2 Label protector with spindle.
- 3 One litre of DISCO-ANTISTAT-MIXTURE.
- 4 Tunnel with filter papers for reuse of DISCO-ANTISTAT-MIXTURE.
- 5 Drying rack and drip tray for 15 records. Fits into base of bath when not in use.

- 1 Boîtier de la machine à laver les disques, munie d'une fine brosse en poils de chèvre.
- 2 Coquilles plastique avec avec axe, protégeant l'étiquette du disque.
- 3 Flacon avec le mélange DISCO-ANTISTAT-MIXTURE pour le lavage et le traitement.
- 4 Entonnoir pour le remplissage du flaon après utilisation de la machine à laver les disques.
- 5 Egouttoir pour 15 disques.

- 1 Vasca di lavaggio con spazzole integrate fatte da pelo di capra.
- 2 Doppio disco per proteggere l'etichetta, con asse per i dischi in vinile 33 e 45 giri.
- 3 1 l di liquido speciale DISCO-ANTISTAT-MIXTURE, riutilizzabile.
- 4 Imbuto per riempire il liquido nel flacone dopo l'uso.
- 5 Rastrelliera di appoggio per 15 dischi a 33 o 45 giri. Dopo l'uso viene sistemata nella vasca.

- 1 Carcasa de lavado con cepillos de borra incorporados.
- 2 Cubiertas herméticas para las etiquetas con eje de suspensión para singles y LPs.
- 3 Botella con 1l de líquido limpiador DISCO-ANTISTAT-MIXTURE. Para varios usos.
- 4 Embudo con el que el líquido se puede volver a verter en la botella desde la carcasa de limpieza tras haber sido utilizado.
- 5 Escurridero con bandeja colectora para 15 LPs o singles. Tras utilizarlo se introduce en la carcasa.

TONAR INTERNATIONAL B.V.
 Beeldschermweg 5 - 1
 3821 AH Amersfoort, The Netherlands
 Tel: +31 33 4554511 * Fax: +31 33 4560544
 email: GLENNLIBGOTT@GMAIL.COM

GENERATION II+

disco-antistat

NEU!

DISCO-ANTISTAT
Art. Nr. 1.3500.01



Schallplatten-Waschgerät

Reinigt schonend rillentief und verhindert dauerhaft statische Aufladungen. Die optimale Schallplattenpflege für ungestörten Musikgenuss.



Macchina lavadischi

La pulizia è dolce ed evita le cariche elettrostatiche per lungo tempo. E' una pulizia perfetta per godersi la musica senza disturbi.



Record-cleaning-kit

Each groove is thoroughly cleaned and will remain static free. The best method of record cleaning essential for maximum listening enjoyment.



Aparato limpiador

Limpia profunda y delicadamente los surcos y evita las cargas estáticas de forma duradera. El cuidado ideal para los discos de vinilo que te permitirá disfrutar de la música sin interferencias.



Lave disque

Nettoie, avec précaution, en profondeur du sillon et évite, à long terme, les charges statiques. L'entretien idéal, permettant de goûter sans troubles les plaisirs de la musique.

knosti[®]

disco-antistat

GENERATION II+

NEU!



1 DISCO-ANTISTAT
Art. Nr. 1.3500.01



5



2



4



3

GENERATION II+

- + Größere Dichtschalen mit Dichtgummi
- + Füllstandsanzeige
- + Antirutschfüße
- + Achshalterung + Handkurbel



- + Large sealing cups with sealing rubber
- + Grands tampons de fermeture vec caoutchouc d'étanchéité
- + Calotte di tenuta più grandi con guarnizioni in gomma
- + Copas de sellado más grandes con goma de sellado
- + Filling level indicator
- + Indicateur de niveau
- + Indicatore di livello
- + Indicador de nivel
- + Hand crank
- + Manivelle
- + Manovella
- + Manivela
- + Shaft lock
- + Freins d'axe
- + Arresto dell'asse
- + Seguros de los ejes
- + Anti-slip feet
- + Pieds antidérapants
- + Piedini antiscivolo
- + Patas antideslizantes

DISCO-ANTISTAT-MIXTURE
1 L: Art. Nr. 1.3010.00

- 1 Waschgehäuse mit eingesetzten Borsten aus Ziegenhaar.
- 2 Label-Dichtschalen mit Aufhängeachse für Singles und LPs.
- 3 Flasche mit 1L Reinigungsflüssigkeit DISCO-ANTISTAT-MIXTURE. Mehrfach verwendbar.
- 4 Trichter, mit dem die Flüssigkeit nach Gebrauch aus dem Waschgehäuse wieder in die Flasche zurückgefüllt wird.
- 5 Abtropfständer mit Auffangschale für 15 LPs oder Singles. Er wird nach Gebrauch in das Gehäuse eingeschoben.

- 1 Record bath with integral brush of soft goats hair.
- 2 Label protector with spindle.
- 3 1 litre of DISCO-ANTISTAT-MIXTURE. Can be reused multiple times.
- 4 Tunnel with filter papers for reuse of DISCO-ANTISTAT-MIXTURE. Can be reused multiple times.
- 5 Drying rack and drip tray for 15 records. Fits into base of bath when not in use.

- 1 Boîtier de la machine à laver les disques, munie d'une fine brosse en poils de chèvre.
- 2 Coquilles plastique qvec avec axe, protégeant l'étiquette du disque.
- 3 Flacon avec le mélange DISCO-ANTISTAT-MIXTURE pour le lavage et le traitement. À usage multiple.
- 4 Entonnoir pour le remplissage du flacon après utilisation de la machine à laver les disques.
- 5 Egouttoir pour 15 disques.

- 1 Vasca di lavaggio con spazzole integrate fatte da pelo di capra.
- 2 Doppio disco per proteggere l'etichetta, con asse per i dischi in vinile 33 e 45 giri.
- 3 1 l di liquido speciale DISCO-ANTISTAT-MIXTURE, riusabile.
- 4 Imbuto per riempire il liquido nel flacone dopo l'uso.
- 5 Rastrelliera di appoggio per 15 dischi a 33 o 45 giri. Dopo l'uso viene sistemata nella vasca.

- 1 Carcasa de lavado con cepillos de borra incorporados.
- 2 Cubiertas herméticas para las etiquetas con eje de suspensión para singles y LPs.
- 3 Botella con 1l de líquido limpiador DISCO-ANTISTAT-MIXTURE. Para varios usos.
- 4 Embudo con el que el líquido se puede volver a verter en la botella desde la carcasa de limpieza tras haber sido utilizado.
- 5 Ecurridero con bandeja colectora para 15 LPs o singles. Tras utilizarlo se introduce en la carcasa.

DISCO-ANTISTAT: Art. Nr. 1.3500.01
DISCO-ANTISTAT-MIXTURE: 1 L: Art. Nr. 1.3010.00

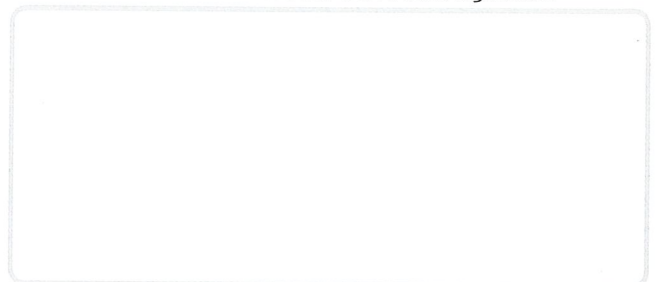

GRADO

hand built high end headphones
made in Brooklyn, New York
since 1953.

GW100 wireless series

the world's first open-back
Bluetooth headphones

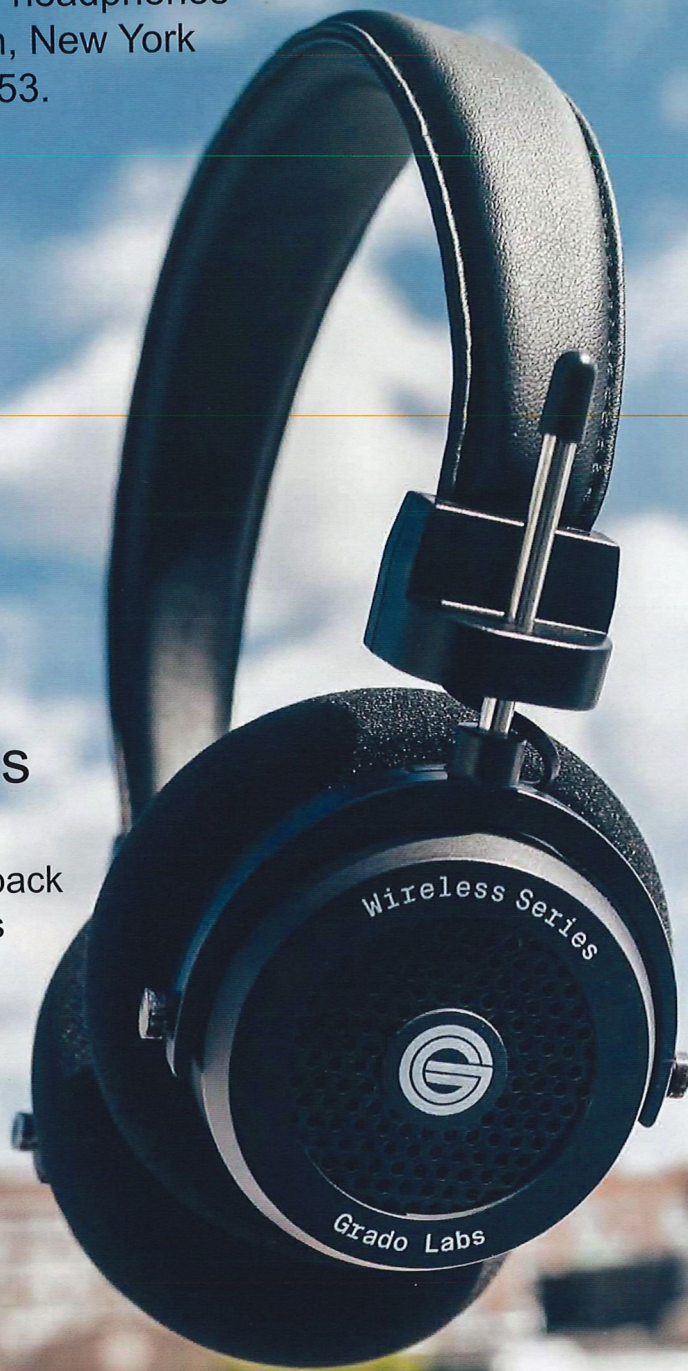

*Nothing is lost.
Except the wires.*

GW100 wireless series

The world's first high end open-back Bluetooth headphones at an entry-level price

Since 1953 Grado Labs has adapted at its own pace, and the first wireless Grado headphone is only the first step in what's to come. We took our time to get the sound just right and made no compromises in the GW100. Nothing is lost except the wires.

Inside the GW100 are none other than our signature Grado drivers. These speakers are the same ones we build for our wired headphones, which are finely tuned for the different enclosures we use. Grado Labs' first wireless headphone is no different, with drivers configured specifically for them. The desired sonic capabilities of the GW100 would not be possible without decades of experience in driver design. Grado has been called "the finest electricity-to-sound transducer in the world," and sound remains the company's top priority.

The GW100 are the worlds first open-back Bluetooth headphones. Their speaker housings and internals have been designed from the ground up, now working in tandem to notably diminish escaping sound by up to 60%.*

These wireless headphones continue to produce a unique sound that is pure Grado, with warm harmonic colors, rich full bodied vocals, excellent dynamics, and an ultra-smooth top end. The GW100 provides clear high end quality at a remarkable entry-level price.



Wireless



Notably reduced escaping sound



Lightweight



Mic & remote

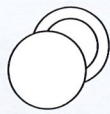

WS cushions



15 hours battery



Audio cable



De-stressed driver



Drivers matched .1dB

Audio Specs:

Bluetooth Version:	4.2 with apt-X
Battery Capacity:	320mAH
Working Distance:	10m
Battery Life:	15 hours**
Frequency Response:	20Hz~20KHz
Mic Sensitivity:	42dB +/- 3dB
Transducer Type:	Dynamic
Operating Principle:	Open Air
SPL 1mW:	99.8 dB
Nominal Impedance:	32 Ω
Drivers Matched dB:	.1 dB

Included Accessories:

Headphones, Warranty, Grado story-sheet, micro-USB charging cable, 3.5mm audio cable.

*As compared to our wired headphones. Leakage reduction varies in certain situations. This is based on a reasonable distance, angle, and genre of music played.

**Based on 50% volume throughout playtime. Battery varies due to volume and musical genre.

Your Grado dealer:

Grado Headphones are exclusively represented in The Netherlands, Belgium and Luxembourg by:
TONAR International B.V. - Beeldschermweg 5 unit 1 - 3821 AH Amersfoort - The Netherlands
Phone: +31 33 - 455 45 11 - Fax: +31 33 - 456 05 44 - E-mail: info@tonar.eu - www.tonar.eu

GRADO

Hand-Crafted High End Headphones



"Truly the World's Finest..."

GRADO

About Grado Labs...

Grado Labs was established by Joseph Grado (1924-2015) in 1953 in Brooklyn. Ever since, Grado has become famous for the remarkable quality and design of their headphones and phonograph cartridges. Joseph Grado has been responsible for more innovations in phono cartridge design than any other person in our lifetime. He has been the inventor of the stereo moving coil phono cartridge and holds more than 48 patents on his name.

In the late 1980s Joseph began the development of what was to become the first true high-end dynamic headphone. The introduction of the Joseph Grado Signature Series of headphones was a major event in the evolution of headphone design. Joseph's painstaking design process, combined with nearly a half century of experience manufacturing precision audio devices, astonished even the most critical reviewers. Joseph extended headphone performance to levels previously attained by only the very best full-range speaker systems in areas of dynamics, pitch control, harmonic accuracy and bass quality. In the process, he once again created a new category - true audiophile quality headphones.



Joseph Grado

In 1990, John Grado, Joseph's nephew, became the President & C.E.O. of Grado Labs. John Grado created and released Grado's first line of headphones that the Brooklyn company is known for today.

Till now, he has created over 60 headphones. This Prestige Series of headphones went on to win more awards than any other headphone line in the world.

John has brought Grado's headphone lines from one generation to the next, introducing every headphone that is available to this day. In 2008 he created The i Series, the second generation of Grado. For the first time, he also decided to enter the in-ear headphone market at the urging of his sons, Jonathan and Matthew. In 2011 the in-ears came to fruition. Now, Jonathan Grado became Vice President of Marketing for Grado Labs

Family run since 1953 for three generations, Grado continues to produce the world's finest headphones, all hand-crafted in Brooklyn, New York. Each individual headphone manufactured by Grado is hand assembled and tested. This meticulous care in design and construction lavished on each Grado headphones contributes to an unchallenged consistency of performance and guarantee of reliability.

For distribution in The Netherlands, Belgium and Luxembourg, Grado headphones are exclusively represented by Tonar International. Since 1954, Tonar has become the specialist for analogue audio, phonograph styli, cartridges and accessories for your turntable and vinyl collection.

tonar
www.tonar.eu

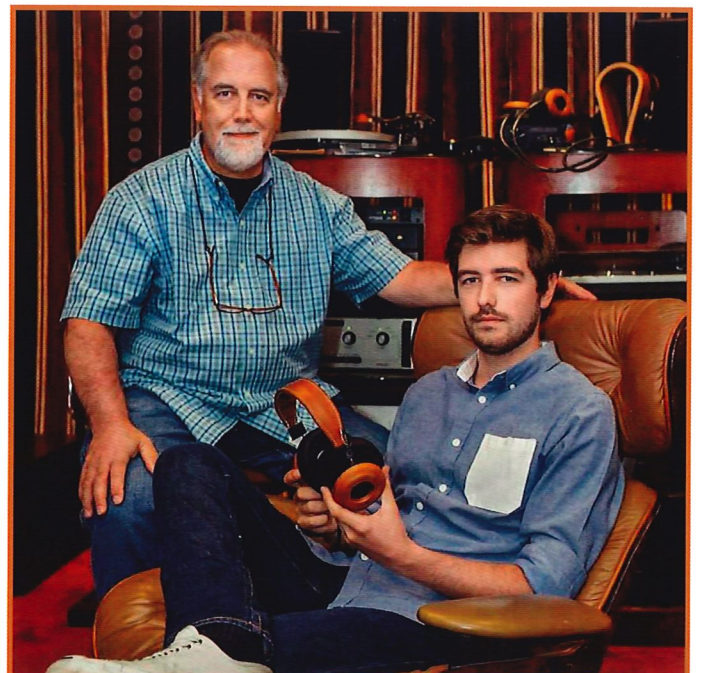

John Grado and his son Jonathan

GRADO

Statement Series



GS2000e

Audio Specs

Transducer Type:	Dynamic
Operating Principle:	Open Air
Frequency Response:	4 - 51,000 Hz
SPL 1mW:	99.8 dB
Nominal Impedance:	32 Ω
Driver Matched dB:	.05 dB

Included Accessories:

Headphones, Warranty, Grado story-sheet, 3.5mm mini adapter, extension cable. A 4-pin XLR balance cable option is available.

Mahogany and Maple, classic tone woods married in audio bliss. The GS2000e combines them in the same manner that luthiers have done for centuries, and for the same reason: resonance. Different types of wood sing with their own personalities while non-fatiguing. All with stunning separation and layering of the music.

The hand-crafted mahogany and maple merged enclosures are a realization of the knowledge from the experience that only Grado Labs knows from working with wood. This technique is used by the finest musical instrument manufacturers from the past and the present. The use of Maple gives the energy of the sound of music to be fully transmitted, then the Mahogany allows it to open up and reveal the true harmonic structure as well as the space that the artist intended.

In addition every component in the GS2000e is considered carefully, the new purpose built 50 mm drivers, the 12 conductor ultra high purity copper cable and ear cushions, all work together for an engaging musical experience. This organic approach embodies what is truly artisanal and is the essence of how we can effectively connect to the music.

GS1000e

Audio Specs

Transducer Type:	Dynamic
Operating Principle:	Open Air
Frequency Response:	8 - 35,000 Hz
SPL 1mW:	99.8 dB
Nominal Impedance:	32 Ω
Driver Matched dB:	.05 dB

Included Accessories:

Headphones, Warranty, Grado story-sheet, 3.5mm mini adapter, extension cable.



Flagship of the handcrafted, carved mahogany series of headphones, the GS1000e 'Statement' is capable of delivering truly stunning sonic performances.

The large chambers fit around your ears, not on top of them, creating a private listening booth. Air flows with the music to keep you comfortable while marveling at the clarity and range. Our select Mahogany tone-woods are hand matched for aesthetic beauty, just as our phenomenal drivers are individually matched for sonic consistency.

The hand-crafted mahogany earpieces utilize an intricate curing process that optimizes the tonal quality while giving them a new look. The GS1000e uses 50mm dynamic transducers and the new 12 conductor cable design. The wood, driver, and cable designs, result in tight control and stability of the upper and lower range of the frequency spectrum to support the GS1000e's world renowned midrange. Grado's GS1000e cushion design actually creates a 'room' for the ears to sit, with a larger soundstage and greater spatial experience for the listener. It was most important to design the correct balance between the driver and our wooden driver housing to give us the pure sound we crave. We believe the GS1000e are one of the most comfortable headphones on the market today. The GS1000e retains a sound that is pure Grado, with warm harmonic colors, rich full bodied vocals, excellent dynamics, and an ultra-smooth top end. The presentation is very detailed, the bass is deep, and the music is very tight while non-fatiguing. All with stunning separation and layering of the music.

GRADO

Professional Series

PS2000e

Audio Specs

Transducer Type:	Dynamic
Operating Principle:	Open Air
Frequency Response:	5 - 50,000 Hz
SPL 1mW:	99.8 dB
Nominal Impedance:	32 Ω
Driver Matched dB:	.05 dB

Included Accessories:

Headphones, Warranty, Grado story-sheet, 3.5mm mini adapter, extension cable. A 4-pin XLR balance cable option is available.



Grado Labs is proud to introduce our new flagship headphone, the PS2000e. This is simply the best headphone we have ever produced and, perhaps, the best in the world. Three generations of the Grado family contributed to its development, which took almost 2 years. Speaking from more than six decades of audio experience... we got it right.

The hand-carved maple inner chamber is clad with our new Smoked Chrome finish for an elegant look. A wider leather head-strap with added padding make for a more comfortable experience. Both are exclusive to the PS2000e.

The unexcelled sonic signature of Maple, first used in our limited edition GH1, deliver a unique desired response. Cladding the wood with metal alloy eliminates ringing and other unwanted distortions. The PS2000e uses a new driver design that also minimizes signal colorations for un-observed detail in your music.

To build our finest headphone yet, you can trust that we used all the best stuff. From the speaker chassis, to the wire, voice coil and magnets, we researched and selected materials of the highest grade. Our diaphragm geometry was redesigned to more accurately convey the signal into music. Developing the new front cap and grill for the new driver resulted in minimized diffractions of the signal emitting from the diaphragm. All this is mounted in a proprietary hybrid housing which gives the driver the utmost support and eliminates distortion and resonance, allowing only the actual signal to come through.

Close your eyes and hear the music like never before, as only a dynamic driver can produce. The PS2000e 'sound stage' is immense and you will enjoy the space and placement of each individual musician. If the artist performed it, and the engineer captured it on the recording, you will hear it.

The PS2000e retains the world famous Grado signature sound, and takes it to a new level of refinement. Be transported. Be Grado.



GRADO



PS1000e

Audio Specs

Transducer Type:	Dynamic
Operating Principle:	Open Air
Frequency Response:	5 - 50,000 Hz
SPL 1mW:	99.8 dB
Nominal Impedance:	32 Ω
Driver Matched dB:	.05 dB

Included Accessories:

Headphones, Warranty, Grado story-sheet, 3.5mm mini adapter, extension cable.

By using tone-wood clad with metal alloy we've obliterated two of the most vexing issues in headphone design: ringing in the chamber, and transient distortion. This gives audio professionals the security of consistent response throughout the frequency range. Did we mention they look awesome?

This hybrid design has an inner sleeve of hand-crafted mahogany made by using the new series 'e' curing process. Its outer housing, machined from aluminum then chrome-plated, utilizes a special processing and casting method to increase the porosity of the alloy. This combination of wood and metal insures that the earphone chamber has no 'ringing' which might obscure detail or add coloration. The way the wood and metal housing moves air and reacts to sound vibrations is virtually unaffected by transient distortions. Grado has also designed the cable for the PS1000e; the twelve-conductor cable design uses UHPLC (Ultra-High Purity, Long Crystal) copper, improves control and stability of the total range of the frequency spectrum. The PS1000e also has a new 50mm driver and a newly re-configured voice coil and diaphragm design, resulting in unsurpassed speed and accuracy responses.

The cushion design creates the correct balance between the driver and housing to support the desired musicality. The cushion design also makes the PS1000e one of the most comfortable headphones in the world. Grado has taken all of our knowledge and over 60 years of experience in controlling resonances and eliminating distortions, and put them into one of our finest headphones ever, the PS1000e. The family is unbelievably proud of this Grado product... listen and enjoy.

PS500e

Audio Specs

Transducer Type:	Dynamic
Operating Principle:	Open Air
Frequency Response:	14 - 29,000 Hz
SPL 1mW:	99.8 dB
Nominal Impedance:	32 Ω
Driver Matched dB:	.05 dB

Included Accessories:

Headphones, Warranty, Grado story-sheet, 3.5mm mini adapter, extension cable.



Most people like music, but Grado PS500e headphones are too good for most people. We make them for music connoisseurs. For the ones who anticipate Amy Winehouse's breath between lyrics. For the ones who absolutely need to place the second violin with their eyes closed. If you get chills from a Cuban trombone solo, we need to talk.

The PS500e is the younger brother to the PS1000e, with newly redesigned 44mm speaker and the improved 8 conductor cable design and a smaller metal and wood hybrid air chamber. Both the hidden mahogany core and powder-coated aluminum housing parts under-go damping treatments that help control and dissipate resonances, for an undistorted flow of the musical signal. The PS500e boasts an overall sound that is pure Grado, with warm harmonic colors, rich full bodied vocals, excellent dynamics, and an ultra-smooth top end. The PS500e is a compact monitoring tool that will put a smile on the face of the most demanding music professionals, as well as the most demanding audiophiles.



Limited Edition

GRADO

Heritage Series

GH2

Audio Specs

Transducer Type:	Dynamic
Operating Principle:	Open Air
Frequency Response:	14 - 28,000 Hz
SPL 1mW:	99.8 dB
Nominal Impedance:	32 Ω
Driver Matched dB:	.05 dB
Vented diaphragm	
Cocobolo air chamber	
UHPLC copper voice coil	
HPIC copper connecting cable	

Included Accessories:

Warranty, Grado story-sheet, 6.5mm Golden Adapter.



We are proud to introduce the second limited edition of our Heritage Series, the cocobolo GH2. Cocobolo, known for fine instruments, furniture, and those chess sets that look too nice to touch, is some of the most beautiful and tonally pleasing woods we have ever used. We're excited that the first Grado to be built from the cocobolo tree is our Heritage Series GH2.

With our first Heritage Series pair, we wanted to pay homage to our Brooklyn roots. We built our GH1 out of maple wood from a fallen tree just a few blocks from where Grado is. It was the first headphone ever built from a Brooklyn tree. While our first headphone in this series focused on our hometown, we wanted to venture further out for the GH2. Cocobolo wood originates from the rain forests of Central America, and its denseness is a primary reason why it produces such a unique sound.

Our limited editions let us experiment with different woods and designs, giving us the opportunity to create a one of a kind Grado. As always, with every wood we use, we wouldn't proceed if we didn't feel its tonal ability was representative of the Grado signature sound. We're extremely pleased to offer the cocobolo GH2 as one of the finest headphones we've ever built at Grado.



GRADO

Reference Series



RS1e

Audio Specs

Transducer Type:	Dynamic
Operating Principle:	Open Air
Frequency Response:	12 - 30,000 Hz
SPL 1mW:	99.8 dB
Nominal Impedance:	32 Ω
Driver Matched dB:	.05 dB

Included Accessories:

Headphones, Warranty, Grado story-sheet, 6.5mm Golden Adapter, extension cable.

Ever wondered what hardcore audiophiles are hearing, and that you might be missing? The Grado RS1e is the point of no return so be warned, cross this threshold and you'll never enjoy mass-market headphones again. Once you've experienced this elegant audio masterpiece you'll grasp the reference.

The new RS1e from Grado uses a different species of handcrafted mahogany from our previous models. The earpieces utilize an intricate curing process that optimizes the tonal quality while giving them a new look. The RS1e places a 50mm dynamic transducer and an 8 conductor cable design in an open-air configuration. The result is a smooth, controlled, and coherent sound with detailed dynamics. Frequency response ranges from 12-30 kHz and the drivers are matched to 0.05dB. Weighing 9oz, the headphones are an example of the wonders of Mother Nature with a gorgeous light mahogany look. The RS1e is a masterpiece in the Grado collection.

RS2e

Audio Specs

Transducer Type:	Dynamic
Operating Principle:	Open Air
Frequency Response:	14 - 28,000 Hz
SPL 1mW:	99.8 dB
Nominal Impedance:	32 Ω
Driver Matched dB:	.05 dB

Included Accessories:

Headphones, Warranty, Grado story-sheet, 6.5mm Golden Adapter.



Leave your candy-colored cans in the toy chest and try a pair of proper headphones. Grado RS2e are hand-crafted from select Mahogany tone-woods, like a fine musical instrument. Our exclusive Series E curing process enhances the natural properties of the wood to produce rich, full-bodied vocals in a light-weight form factor. Put on Brian Eno's 'Another Green World', close your eyes and dream as if you'll live forever.

The RS2e is the little brother of the RS1e but is just as aesthetically pleasing, now utilizing our proprietary curing process that gives a new, lighter look. The RS2e has a 44mm driver and uses The e Series 8 conductor cable design. The hand-crafted mahogany utilizes new advanced damping treatments that help control and dissipate resonances. The RS2e still maintains an overall sound that is pure Grado, with warm harmonic colors, rich full bodied vocals, excellent dynamics, and an ultra-smooth top end. These truly are an audiophiles dream.



GRADO

Prestige Series

SR60e

Audio Specs

Transducer Type:	Dynamic
Operating Principle:	Open Air
Frequency Response:	20 - 20,000 Hz
SPL 1mW:	99.8 dB
Nominal Impedance:	32 Ω
Driver Matched dB:	.1 dB

Included Accessories:

Headphones, Warranty, Grado story-sheet, 6.5mm Golden Adapter.



Everyone loves a thumping bass and kick-drum, but not at the expense of everything else. The Grado SR60e is your entry to the world of full spectrum audio. You'll actually hear notes you never knew were there. Perhaps your audiophile friends have fueled a desire for the legendary Grado sound but you thought it was out of reach. Try a pair of our affordable open-back headphones and experience fuller, more realistic sound. Club-footed imports can't match the sonic enlightenment from Brooklyn, USA.

Grado has taken one of the world's most legendary headphones and made it even better. The SR60e has a new driver design, a new polymer to better damp resonant distortion in the plastic housing, and a new cable from plug to driver connection. The way the SR60e's new driver and plastic housing move air and react to sound vibrations virtually eliminate transient distortions. This allows the signal flow over the new cable to reproduce sound that has tight control of the upper and lower range of the frequency spectrum, while supporting Grado's world renowned midrange. The SR60e will produce a sound that is pure Grado, with warm harmonic colors, rich full bodied vocals, excellent dynamics, and an ultra-smooth top end.

eGrado

Audio Specs

Transducer Type:	Dynamic
Operating Principle:	Open Air
Frequency Response:	20 - 20,000 Hz
SPL 1mW:	101 dB
Nominal Impedance:	32 Ω
Driver Matched dB:	.1 dB

Included Accessories:

Headphones, Warranty, Grado story-sheet.



Our fabulous eGrado headphones make a great companion on trips, from the air to the underground. Affordable, lightweight and sound great. Wish you could take your favorite brand of headphones on your next flight? A major airline had the same idea and is using eGrado on selected flights to the great delight of passengers.

Designed for the portable electronics market, our goal was to create a street-style headphone that will sonically outperform anything available in the affordable portable market. The eGrado is functionally stylish, lightweight and comfortable. By incorporating the same drivers used in our highly regarded SR60 headphones, we can proudly state that we are indeed the high end choice in the portable market. The eGrado features a behind the neck headband that is comfortable and stylish. We have indeed kept the highly praised Grado sound at a price point that is within reach of all.

GRADO

In-Ear Series



GR8e

Audio Specs

Driver:	Moving Armature
Connector:	3.5mm stereo mini-plug
Frequency Response:	20 -20,000 Hz
Sensitivity:	118dB/1mW
Nominal Impedance:	32 Ω
Max Input Power:	20mW
Cable:	51"/130cm
Weight:	9 grams

Included Accessories:

3 pair ear tips (S M L) proprietary blend of two silicons
Ear wax proof cloth x4
Ear wax proof cloth ring x2

A proprietary wide bandwidth moving armature design provides the listener with unsurpassed performance. Small size allows earphone to nestle well within the ear canal, maintaining an excellent air seal for improved bass and reduction of outside noise without causing discomfort.

GR10e



Audio Specs

Driver:	Moving Armature
Connector:	3.5mm stereo mini-plug
Frequency Response:	20 -20,000 Hz
Sensitivity:	113dB/1mW
Nominal Impedance:	32 ohms
Max Input Power:	20mW
Cable:	51"/130cm
Weight:	9 grams

Included Accessories:

3 pair ear tips (S M L) proprietary blend of two silicons
Ear wax proof cloth x4
Ear wax proof cloth ring x2

Learning never ends and the GR10e is a result of a constant desire to look at designs and materials and improve upon them. A higher level of precision and new materials allows for the performance of the GR10e to add frequency extension in both the high and low ranges as well as reducing distortion.

iGe

Audio Specs

Driver:	Dynamic
Connector:	3.5mm stereo mini-plug
Frequency Response:	20 -20,000 Hz
Sensitivity:	105dB/1mW
Nominal Impedance:	24 ohms
Max Input Power:	30mW
Cable:	51"/130cm
Weight:	9 grams

Included Accessories:

Four sets of ear tips.

The Grado iGe is the latest in our line of high performance In-Ear headphones. With improved driver response, the proprietary wide bandwidth design provides the listener with an unequalled performance at this price point. The iGe headphone is also the first of Grado's headphones to include an Apple licensed controller which includes a microphone and offers the capability to control volume, music tracks, phone calls, and Siri. The addition of the controller makes this more than just a great sounding headphone, it's now a communication tool to help you navigate the busy world we live in today.

When Grado sets out to design a new product, the most important goal is to be faithful to the music. To also be able to improve the listeners overall experience with the controller is just icing on the cake.





Your Grado dealer:

Grado Headphones are exclusively represented in the The Netherlands, Belgium and Luxembourg by:

TONAR International B.V. - Beeldschermweg 5 unit 1 - 3821 AH Amersfoort - The Netherlands

Phone: +31 33 - 455 45 11 - Fax: +31 33 - 456 05 44 - E-mail: info@tonar.eu - www.tonar.eu

GRADO

Hand-Crafted High End Phonograph Cartridges



“Truly the World’s Finest...”

GRADO

About Grado Labs...

Grado Labs was established by Joseph Grado (1924-2015) in 1953 in Brooklyn. Ever since, Grado has become famous for the remarkable quality and design of their phonograph cartridges. Joseph Grado has been responsible for more innovations in phono cartridge design than any other person in our lifetime. He has been the inventor of the stereo moving coil phono cartridge and holds more than 48 patents on his name.

Born in New York, Joseph Grado left vocational high school at the age of 16, where he had been studying watch-making and had been at the top of his class. He went to work for Tiffany & Company and also taught the craft of watch-making in the evenings. When he discovered hi-fi sound in the early fifties, he visited Saul Marantz to get help in improving the sound of his audio system. Impressed by Joseph's gifted ear, Marantz sent him over to Sherman Fairchild's floundering hi-fi division. With Saul Marantz making the introductions, Joseph promptly landed a top position in the company. As soon as he came up with a design for a viable product, he went out on his own. Scraping together \$2,000, Joseph began to produce phono cartridges. In 1953 he started production of his cartridges on the kitchen table, Grado Labs' first home. In 1955 Joseph opened a factory in Brooklyn on the site of his Sicilian born father's grocery business which, to this day, has been the home of Grado Laboratories.



Joseph Grado

In the early years Grado also produced speakers, turntables and the highly acclaimed wooden tone-arm, which came in several models. In 1963 all of Grado's resources were dedicated to creating the world's finest phono cartridges. In 1976 phono cartridge design was taken to the next level and the first true high-end cartridges were created under the tutelage of Joseph Grado Signature Products.

In 1990, John Grado, Joseph's nephew, became the President & C.E.O. of Grado Labs. He redesigned the entire Grado line of phono cartridges and introduced the wooden Grado housing. Grado's system of damping has virtually eliminated resonant distortions in the magnetic and electrical circuits in the cartridge, bringing analog to a new level of performance. The wooden Reference and Statement Series of phono cartridges have been honored with a Golden Note Award for analog design. Grado also revised the entry level cartridges with the Prestige Series which has been touted as the "Best Value" in phono cartridges in the world.

Family run since 1953 for three generations, Grado continues to produce the world's finest phono cartridges, all hand-crafted in Brooklyn, New York. Each individual cartridge manufactured by Grado is hand assembled and tested for frequency response, channel output, channel balance, phase linearity, inductance and resistance. This meticulous care in design and construction lavished on each Grado cartridge contributes to an unchallenged consistency of performance and guarantee of reliability.

For distribution in The Netherlands, Belgium, Luxembourg, the United Kingdom and Ireland, Grado cartridges are exclusively represented by Tonar International. Since 1954, Tonar has become the specialist for phonograph styli, cartridges and accessories for your turntable and vinyl collection.

tonar
www.tonar.eu



GRADO

Lineage Series

GRADO LINEAGE SERIES



In 1953, Joseph Grado and his family started building cartridges on their kitchen table. Every experience gained in the development of cartridges since the early days has led to the creation of the Lineage Series, consisting of the Epoch and Aeon cartridges. The Epoch and Aeon represent the craftsmanship and unwavering dedication to sound that has been Grado's main focus for over half a century.

The Grado Epoch, is the flagship cartridge of the Lineage Series. For the first time in the history of Grado, sapphire, gold, diamond, and cocobolo wood join forces to produce the finest hand-built

cartridge ever.

The Epoch and Aeon are two cartridges that offer exceptional reproduction of vocals and instruments, with superlative tonal balance, dynamics, imaging, and realism. Grado's coil winding techniques, which have been honed throughout the decades, have let them achieve exact unison between the four coils in each phono cartridge. This allows for a precise balance between channels and accurate stereo imaging. Each Grado is wound with the finest properly sized and annealed 24-karat solid gold wire, which is the ultimate conductor for the transmission of the music from your record.

All of the internal magnetic circuit parts are Swiss screw machined or molded metal, which have tolerances on the order of the best Swiss-made watches. The specially designed diamond stylus, for the first time in a Grado, is mounted on a sapphire cantilever that connects to the stylus generating system. The Epoch and Aeon feature a unique system that has the lowest effective moving mass of any cartridge, while Grado's patented Flux-Bridger generator design creates a superior balance throughout the full frequency spectrum with superb resolution and clarity, which produces an overall truer picture of the music. This is all nestled inside a cocobolo wooden housing.

GRADO EPOCH

Output = 1mV @ 5 CMV
Controlled frequency response = 6 Hz - 72,000 Hz
Channel separation: avg. 47dB - 6 Hz - 72,000 Hz
Loading: 47,000 Ω
Inductance: 30 mH
Resistance: 91 Ω
Non-sensitive to capacitive load
Chassis mass: 12 grams
Tracking force: 1.5 - 1.9 grams



GRADO

Prestige Series

GRADO PRESTIGE SERIES

The Prestige 2 Series is Grado's updated entry level line of cartridges, offering high performance phono cartridges at affordable prices. The cartridges make use of Grado's optimized transmission line (OTL) technology. OTL provides an ideal transfer of signal from the surface of the LP to the generator of the system. This technology rejects unwanted resonances and lowers distortion preserving the fundamental and harmonic frequencies of the music. This also helps keep noise generated by the motor system in the cartridge to a minimum. Grado's OTL stylus/cantilever design makes records sound quieter, improves the height, width, and depth of the soundstage, and present more detail than previously obtainable. All Prestige models available in both ½ inch mount and T4P-mount. All styli in the Prestige series are user replaceable.

The Prestige cartridges are hand assembled by the Grado team in Brooklyn, with some builders having over 25 years of experience. With the recent development of the highly received Lineage Series of cartridges, new technologies have been applied to the Prestige line as well. This updated series of cartridges offers excellent tonal balance, dynamics, and realism, for a most rewarding reproduction of vocals and instruments. The unique coil winding techniques, using ultra high purity copper wire which were honed during the development of the Lineage Series, have let the electrical circuits achieve unison between the four coils in each phono cartridge. This allows for a precise balance between channels and accurate stereo imaging.

The Prestige cartridges are powered by a twin magnet system that optimizes the balance between stereo channels. All internal magnetic circuit parts are held to extremely high tolerances creating the desired stereo imaging. Grado's patented Flux-Bridger design allows the Prestige cartridges to have one of the lowest effective moving mass generating systems while creating an excellent balance throughout the full frequency range.

The development of the Epoch in the Lineage Series brought an in-depth experience with using an outer housing as a damping device. This led to the creation of a process which de-stresses the chassis and dissipates unwanted energy & resonant frequencies, allowing the desired signal to travel freely.

GOLD2



RED2



GREEN2

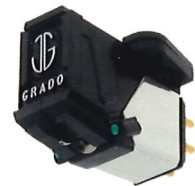

SILVER2



BLUE2



BLACK2



Frequency Response: 10 - 60.000 Hz
Principal: MI
Channel Separation: 35 (at 1 KHz)
Input Load: 47K
Output: 5mV (5 cm/sec)
Tracking Force: 1.5 gram
Stylus Type: Elliptical
Inductance: 45mH
Resistance: 475
Compliance CUs: 20 mm/N
Stylus Replacement: User replaceable
Mounting: ½ inch/T4P
Weight: 5.5 gram

Frequency Response: 10 - 55.000 Hz
Principal: MI
Channel Separation: 30 (at 1 KHz)
Input Load: 47K
Output: 5mV (5 cm/sec)
Tracking Force: 1.5 gram
Stylus Type: Elliptical
Inductance: 45mH
Resistance: 475
Compliance CUs: 20 mm/N
Stylus Replacement: User replaceable
Mounting: ½ inch/T4P
Weight: 5.5 gram

Frequency Response: 10 - 50.000 Hz
Principal: MI
Channel Separation: 30 (at 1 KHz)
Input Load: 47K
Output: 5mV (5 cm/sec)
Tracking Force: 1.5 gram
Stylus Type: Elliptical
Inductance: 45mH
Resistance: 475
Compliance CUs: 20 mm/N
Stylus Replacement: User replaceable
Mounting: ½ inch/T4P
Weight: 5.5 gram

Both the Silver2 and Gold2 use a four piece OTL cantilever with a Grado specific elliptical diamond stylus mounted on a brass bushing. With the Silver2 and Gold2, a machined turned generator is used to achieve a lower distortion and greater transparency. The Gold2 are hand selected from Silver2 production runs which meet higher test specifications. Approximately 5% of the run usually exhibits these specs and become a Gold2.

Both the Blue2 and Red2 use a four piece OTL cantilever that has a Grado specific diamond mounted on a brass bushing. The Red2 are hand selected from Blue2 production runs which meet higher test specifications. Approximately 10% of the run usually exhibits these specs and become a Red2.

Both the Black2 and Green2 use a three piece OTL cantilever that has a Grado specific diamond mounted on a brass bushing. The Green2 are hand selected from Black2 production runs which meet higher test specifications. Approximately 15% of the run usually exhibits these specs and become a Green2.

GRADO

Prestige Specialty Series

GRADO PRESTIGE SPECIALTY SERIES



SPECIALTY: 78 RPM



The Prestige Specialty Series of 78-RPM cartridges are designed for high output and excellent stability under even severe use. The experts acclaim these cartridges as virtually the finest 78-rpm cartridges in the world. There are two versions available: the Grado 78C and the Grado 78E.

Frequency Response: 10 - 50,000 Hz
Principal: MI

Input Load: 47K
Output: 5mV (5 cm/sec)
Tracking Force: 2.5 gram
Stylus Type: Conical
Inductance: 45mH
Resistance: 475

Stylus Replacement: User replaceable
Mounting: 1/2 inch/T4P
Weight: 5.5 gram

Each cartridge can be used for either archival or casual play without concern for undue wear on the record. All Grado 78 cartridges have a considerable reduction in tip mass resulting in extended frequency response while tracking forces can range from 2-5 grams. The 78C cartridge uses a three-piece OTL cantilever technology. The 78E cartridge uses a modified four-piece OTL cantilever technology.

SPECIALTY: MONO PHONO

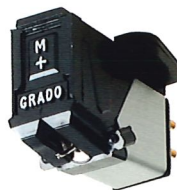

There are many analog lovers with record collections that include mono albums. Grado strives to have products that will fit all the needs of the analog enthusiast. There are two versions available: the MC+ and the ME+.

Frequency Response: 10 - 50,000 Hz
Principal: MI

Input Load: 47K
Output: 5mV (5 cm/sec)
Tracking Force: 1.5 gram
Stylus Type: Elliptical
Inductance: 45mH
Resistance: 475

Stylus Replacement: User replaceable
Mounting: 1/2 inch/T4P
Weight: 5.5 gram

The MC+ and the ME+ are mounted with an elliptical diamond. The MC+ uses a three-piece OTL cantilever technology. The ME+ uses a modified four-piece OTL cantilever technology. The ME+ uses one of Grado's upgraded generating systems. All wooden body cartridges are available in mono version. This will make your records quieter and enhance the musical pleasure of these recordings.

SPECIALTY: DJ

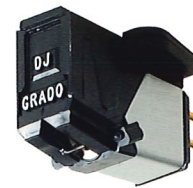

Grado's DJ cartridges are the most advanced phono pickups ever offered to the professional DJ market. Built and designed for the demanding needs of the professional DJ musician, Grado cartridges deliver musical performance never known before in the pro DJ market. There are two versions available: the DJ100 and the DJ200.

Frequency Response: 10 - 50,000 Hz
Principal: MI

Channel Separation: 30 (at 1 KHz)
Input Load: 47K
Output: 5mV (5 cm/sec)
Tracking Force: 2.5 gram
Stylus Type: Diamond
Inductance: 45mH
Resistance: 475

Compliance CUs: 30
Stylus Replacement: User replaceable
Mounting: 1/2 inch/T4P
Weight: 5.5 gram

The Prestige model DJ100 uses a three-piece OTL cantilever technology. The Prestige model DJ200 uses a modified four piece OTL cantilever technology. Both cartridges use oxygen free wire in the coils and a specially designed, high polished, diamond mounted in a brass bushing. The Grado specially engineered transmission line cantilever allows for the ideal transfer of music signal and for safe and effective stylus back-cueing.

GRADO

Hand-Crafted High End Phonograph Cartridges

"Truly the World's Finest..."



Your Grado dealer:

Grado cartridges are exclusively represented in the The Netherlands, Belgium, Luxembourg, the United Kingdom and Ireland by:

TONAR International B.V. - Beeldschermweg 5 unit 1 - 3821 AH Amersfoort - The Netherlands

Phone: +31 33 - 455 45 11 - Fax: +31 33 - 456 05 44 - E-mail: info@tonar.eu - www.tonar.eu

JICO®

瀬戸彫 *Seto-Hori*

Cellule MC fabriquée à la Main
avec un Corps en Céramique dotée
d'une Pointe de profil Micro-Ridge
et d'un Cantilever en Bore.



*Saisir le Bonheur,
en Capturant un Beau Son*

JICO®

瀬戸彫 *Seto-Hori*



En tant que fabricant historique de diamants Hi-Fi, établi il y a 140 ans, JICO lance actuellement la cellule "SETO-HORI" à bobine mobile (Moving Coil/MC). La cellule SETO-HORI MC est fabriquée au cœur de la ville de Seto, au Japon. Cette ville est célèbre pour sa poterie et sa céramique. Tant et si bien que le mot générique pour la céramique en japonais est "Setomono".

On a longtemps pensé qu'il était impossible d'utiliser de la céramique pour les cellules. Le moulage ("Kata-Tori") et la cuisson ("Yaki-ire") sont des procédés clés pour les produits céramiques. Cependant, pendant le processus de cuisson, la céramique rétrécit considérablement en taille, et pour cette raison il a été dit que la céramique n'est pas appropriée pour la cabine de cellules. Pendant deux ans, les experts en diamants Hi-Fi de JICO ont travaillé en collaboration avec un laboratoire à Seto et ont étudié le retrait avec une poterie. Le résultat est la cellule SETO-HORI MC avec un corps céramique magnifiquement conçu, un son splendide et une philosophie authentiquement japonaise.

Le dessin unique de la cellule SETO-HORI ressemble aux filets de pêche des pêcheurs japonais. Il suit la philosophie de 'saisir le bonheur en capturant de beaux sons'. Le motif détaillé imitant les filets de pêche n'est pas peint au pinceau, mais dessiné par le moule par une technique appelée "Hori-Tsuke".

La cabine céramique Setomono supprime les vibrations excessives de la cellule haute tension de sortie MC. La cellule SETO-HORI utilise une pointe spéciale de profil micro-ridge, qui a une forme polyédrique. Comme il s'agit d'un diamant Hi-Fi traditionnel, sa durée de vie est au moins trois fois plus longue que celle d'un diamant de forme conique ou elliptique.

Le cantilever en Bore possède une faible masse mais une grande rigidité. Ces caractéristiques permettent à la pointe de tracer plus précisément le sillon et de reproduire les fréquences basses, moyennes et hautes avec une véritable fidélité.

Le corps de la cellule est monté sur un socle en noyer naturel et est traité près de Hamamatsu, la ville célèbre pour ses usines d'instruments de musique de classe mondiale. La combinaison de la céramique japonaise traditionnelle et du bois naturel donne un charme supplémentaire au son.

La cellule SETO-HORI MC est exclusivement fabriquée à la main au Japon.



Moulage du SETO-HORI

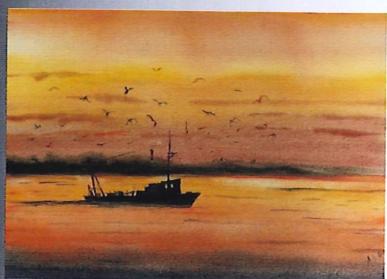

Pêcheurs japonais

Specifications:

Tension de sortie:	2mV
Equilibre des canaux en sortie:	<1,5dB/1kHz
Force d'Appui:	2.0 g
Séparation des canaux:	25dB/1kHz
Réponse en fréquence:	15-32 000 Hz
Impédance de sortie:	130Ω/1kHz
Cantilever:	Bore
Fixation du diamant Hi-Fi:	Micro Ridge
Poids net du produit:	11 g
Étui de protection:	Céramique de Seto et bois de noyer

Toutes les cellules sont transportées avec un contrôle d'expédition et une vérification du son à 100%.

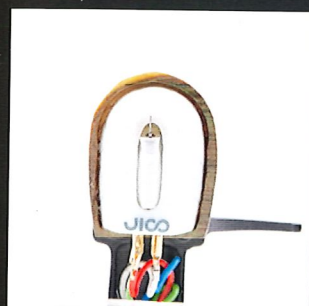

La pointe de profil Micro-Ridge



À propos de JICO

En 1873, JICO a commencé son parcours en fabricant des aiguilles à coudre pour Kimonos. Depuis, l'entreprise a acquis une nouvelle expertise technique et artisanale. En 1964, JICO a fusionné ces compétences pour créer des diamants Hi-Fi qui sont devenus la référence de qualité aujourd'hui. Tous les diamants sont assemblés manuellement et chaque diamant est contrôlé individuellement par des *Takumi* (Artisans Japonais) qui mettent tout leur cœur dans chaque produit qu'ils créent. JICO est motivé et dévoué à la préservation de la culture et du son des disques vinyles.

JICO - NIPPON PRECISION JEWEL INDUSTRY CO. LTD.,
Tsutsui Shirokanedai Bld. 3F, 4-9-23 Shirokanedai, Minato-ku, Tokyo 108-0071 Japan

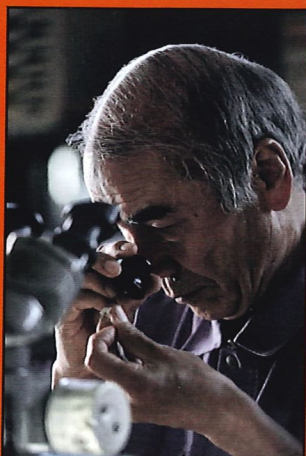

JICO est représenté en exclusivité par Tonar International pour la distribution en Europe, en Afrique et au Moyen-Orient.

TONAR International B.V. - Beeldschemweg 5 unit 1 - 3821 AH Amersfoort - Pays-Bas
Téléphone : +31 33 - 455 45 11 - Fax : +31 33 - 456 05 44 - E-mail : info@tonar.eu - www.tonar.eu



The UK's number one brand for hand-made
turntable cartridges. Pushing the boundaries of
audio technology since 1906.

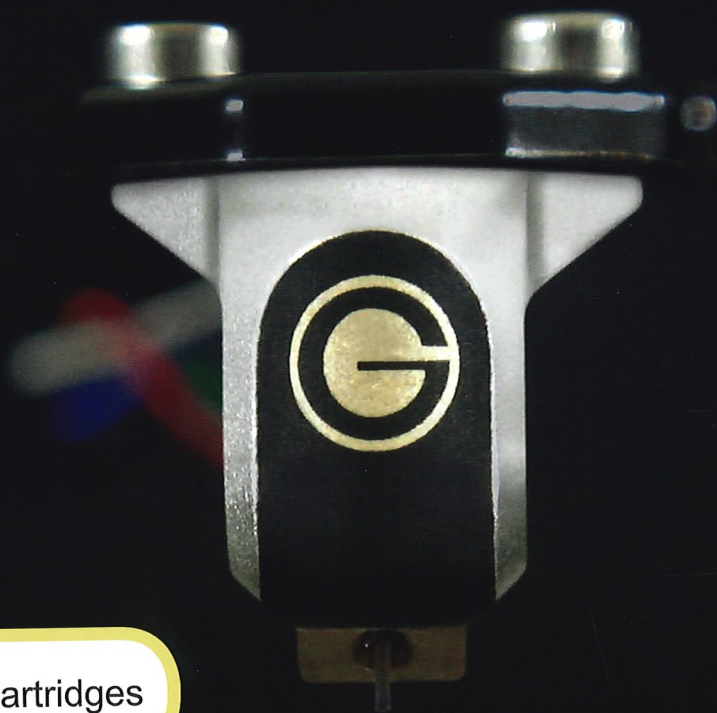

Moving Magnet Cartridges



Moving Iron Cartridges



Moving Coil Cartridges



E SERIES

moving magnet cartridges

For more than 100 years, the Goldring philosophy has been to promote the precise replication of the original recording, maintaining the creative nuances, musicality and rhythm that the artist intended for you to hear. With the E Series, this is achieved with the three cartridges in the range that have been designed to capture this musical experience. All E series cartridges use Magnetic Duplex™ technology, which achieves a more accurate stereo reading.

Magnetic Duplex™ Technology

The Goldring E Series cartridges feature a special dual magnet arrangement. Magnetic Duplex Technology™ uses two low mass magnets which interact only with the partnering pickup coil, angled at 45 degrees to match the cutting head arrangement. This enables the cartridges to more accurately trace the record groove because they precisely emulate the geometry of the cutting head, making for better stereo separation and a more accurate, involving and musical soundstage.

Expert Adjustment

The E Series cartridges have been designed to allow micro-adjustments to be made during production using a special adjustment screw. This means the cartridge can be safely installed in a typical turntable because the angle that the stylus makes with the record surface (azimuth) has been pre-set. The result is an optimised channel balance with zero degrees of horizontal tracking adjustment required. This ensures a consistent and reassuring performance for the life of the product.

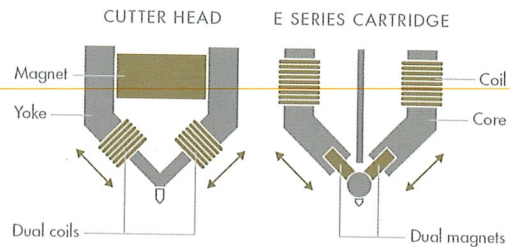

E1



The E1 features a bonded, spherical (0.6 mil) stylus with a round shank. This makes the cartridge "extremely forgiving of set-up adjustment". Also features a carbon reinforced ABS cantilever tube, an effective alternative to more premium aluminium or boron materials.

Cantilever	Carbon
Stylus profile	Spherical
Stylus radius	0.6 mil
Frequency range	20 Hz - 20,000 Hz
Channel balance	1.5 dB at 1 kHz
Channel separation	>20 dB at 1 kHz
Sensitivity	3.5 mV (1 kHz @ 5 cm/sec)
Static compliance	20 mm/N
Tracking angle	208
Load resistance	47 KΩ
Load capacitance	100 - 200 pF
Internal inductance	400 mH
Internal resistance	410Ω
Cartridge mass	6.9 g
Fixing centres	12.7 mm (0.5")
Playing weight	1.5 g - 2.5 g (2.0 g. opt.)

E2



The E2 features the same spherical stylus profile as the E1 but with the additional benefit of an upgraded aluminium cantilever. This is both stiff and light weight allowing the stylus to more accurately trace medium to high frequencies offering more detail and reducing distortion and mis-tracking during loud passages.

Cantilever	Aluminium
Stylus profile	Spherical
Stylus radius	0.6 mil
Frequency range	20 Hz - 20,000 Hz
Channel balance	1.5 dB at 1 kHz
Channel separation	>20 dB at 1 kHz
Sensitivity	3.5 mV (1 kHz @ 5 cm/sec)
Static compliance	20 mm/N
Tracking angle	208
Load resistance	47 KΩ
Load capacitance	100 - 200 pF
Internal inductance	400 mH
Internal resistance	410Ω
Cartridge mass	6.9 g
Fixing centres	12.7 mm (0.5")
Playing weight	1.5 g - 2.5 g (2.0 g. opt.)

E3



The E3 cartridge utilizes an aluminium cantilever as the E2, but benefits from a superior bonded, super-elliptical stylus. This gives it superior high frequency groove detail retrieval ability over ordinary elliptical or spherical styli due to its smaller front to back radius. Its main effect is the reduction of sibilance, especially in high level vocal recordings.

Cantilever	Aluminium
Stylus profile	Elliptical
Stylus radius	0.3 x 0.7 mil
Frequency range	20 Hz - 20,000 Hz
Channel balance	1.5 dB at 1 kHz
Channel separation	>20 dB at 1 kHz
Sensitivity	3.5 mV (1 kHz @ 5 cm/sec)
Static compliance	20 mm/N
Tracking angle	208
Load resistance	47 KΩ
Load capacitance	100 - 200 pF
Internal inductance	400 mH
Internal resistance	410Ω
Cartridge mass	6.9 g
Fixing centres	12.7 mm (0.5")
Playing weight	1.5 g - 2.5 g (2.0 g. opt.)



G1000 SERIES

moving magnet cartridges

GOLDRING 1006

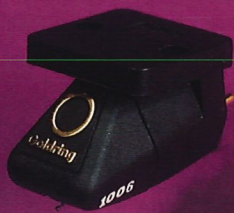

This hand-built cartridge features a nude elliptical stylus; its shape enables it to more accurately trace the highest frequency record grooves giving it the advantage over ordinary spherical types. The natural diamond shank also gives the stylus a lower tip mass than cheaper metal bonded types lending the cartridge an improved transient response.

Frequency Response	20 Hz -20 kHz \pm 3 dB
Channel Balance	within 2 dB @ 1 kHz
Channel Separation	better than 25 dB @ 1 kHz
Sensitivity	6.5 mV \pm 1.5 dB, 1 kHz @ 5 cm/sec
Static Compliance	20 mm/N
Dynamic Compliance	@ 10 Hz 10 mm/N
Equivalent tip mass	0.45 mg
Vertical Tracking Angle	24°
Stylus Radius	Elliptical
Stylus Type	Replaceable
Load Resistance	47 k Ω
Load Capacitance	150-200 pF
Internal Inductance	570 mH
Internal Resistance	660 Ω
Cartridge Mass	6.3 g
Cartridge Mass (incl. fixings)	7.6 g
Fixing Centre	12.7 mm (0.5")
Playing Weight	1.5 - 2.0 g (1.7 g nom.)
Replacement Stylus	1006 - D06

GOLDRING 1012GX

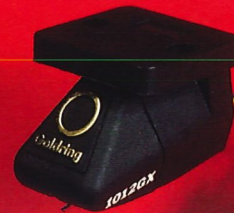

The 1012GX uses the acclaimed Gyger II nude diamond stylus. A fine-line elliptical type with a 6 μ m small radius it gives smooth, extended highs, low distortion and reproduces a highly detailed and dynamic sound. Advanced diamond tip polishing ensures excellent tracking ability. Due to its larger major radius, the 1012GX fills the groove completely.

Frequency Response	20 Hz - 20 kHz +/- 3 dB
Channel Balance	within 2 dB @ 1 kHz
Channel Separation	better than 25 dB @ 1 kHz
Sensitivity	6.5 mV +/- 1.5 dB, 1 kHz @ 5 cm/sec
Static Compliance	20 mm/N
Dynamic Compliance	@ 10 Hz 10 mm/N
Equivalent tip mass	0.45 mg
Vertical Tracking Angle	24°
Stylus Radius	Gyger II
Stylus Type	Replaceable
Load Resistance	47 k Ω
Load Capacitance	150 - 200 pF
Internal Inductance	570 mH
Internal Resistance	660 Ω
Cartridge Mass	6.3 g
Cartridge Mass (incl. fixings)	7.6 g
Fixing Centre	12.7 mm (0.5")
Playing Weight	1.5 - 2.0 g (1.7 g nom.)
Replacement Stylus	1012GX - D12GX

GOLDRING 1022GX



The 1022GX cartridge is recommended for the discerning listener as it uses a vital-shank, nude, diamond stylus. This polyhedral, line-contact diamond profile has a very low tip-mass and a large contact area whilst being very narrow from front to back, even enabling the undistorted retrieval of ultrasonic frequencies in a recording.

Frequency Response	20Hz - 20kHz \pm 3 dB
Channel Balance	within 2 dB @ 1 kHz
Channel Separation	better than 25 dB @ 1 kHz
Sensitivity	6.5 mV \pm 1.5dB, 1kHz @ 5 cm/sec
Static Compliance	20 mm/N
Dynamic Compliance	@ 10 Hz 10 mm/N
Equivalent tip mass	0.45 mg
Vertical Tracking Angle	24°
Stylus Radius	Vital PH
Stylus Type	Replaceable
Load Resistance	47 k Ω
Load Capacitance	150 - 200 pF
Internal Inductance	570 mH
Internal Resistance	660 Ω
Cartridge Mass	6.3 g
Cartridge Mass (incl. fixings)	7.6 g
Fixing Centre	12.7 mm (0.5")
Playing Weight	1.5 - 2.0 g (1.7 g nom.)
Replacement Stylus	1022GX - D22GX

GOLDRING 1042



The 1042 is made for the audiophile who demands the ultimate sonic performance from their system. It uses a nude, natural-diamond stylus with a Gyger S profile. This is a revolutionary line-contact type which is shaped closely resemble the record cutting head than. The 1042 traces the smallest groove detail with complete fidelity.

Frequency Response	20 Hz-20 kHz +/- 3 dB
Channel Balance	within 2 dB @ 1 kHz
Channel Separation	better than 25 dB @ 1 kHz
Sensitivity	6.5 mV +/-1.5 dB, 1 kHz @ 5 cm/sec
Static Compliance	20 mm/N
Dynamic Compliance	@ 10 Hz 10 mm/N
Equivalent tip mass	0.45 mg
Vertical Tracking Angle	24°
Stylus Profile	Gyger S
Stylus Type	Replaceable
Load Resistance	47 k Ω
Load Capacitance	150-200 pF
Internal Inductance	570 mH
Internal Resistance	660 Ω
Cartridge Mass	6.3 g
Cartridge Mass (incl. fixings)	7.6 g
Fixing Centre	12.7 mm (0.5")
Playing Weight	1.5 - 2.0 g (1.7 g nom.)
Replacement stylus	1042 - D42



G2000 SERIES

moving iron cartridges

All Goldring 2000 series cartridges feature moving Iron technology. This lends them the high levels of detail associated with more expensive moving coil designs whilst retaining the convenience of a replaceable stylus and high output associated with moving magnet types. The cartridge employs a fixed samarium cobalt magnet and high output coil combination so that a very light iron/nickel cantilever end-piece can be used instead of the much heavier permanent magnet used in conventional designs. This reduces the moving mass allowing the stylus to trace the record groove more faithfully. Because of their high output, Goldring 2000 series cartridges should be used with the standard moving magnet phono input of an integrated amplifier.

Moving iron technology

The moving iron (MI) cartridge is similar in operation to the moving-magnet type except that a very light, hollow, temporary magnet or armature is used instead of a small permanent magnet. This has the advantage that the moving parts of the generator can be made from light magnetic alloys and therefore have less mass, responding to the groove wall more accurately. The cantilever transfers the mechanical vibrations from the record groove to the hollow armature. The magnetic field induced in it by the large fixed permanent magnet suspended above it induces a changing magnetic "flow" through the pole shoes which, in turn, generates an electromotive force in the fixed coils in proportion to the mechanical vibration.

The coil must be connected to a special phono amplifier input via the turntable leads so that the low voltage generated by the cartridge (typically 5 mV) is boosted to several volts to drive the speakers. All MI cartridges have a relatively high output and require a 47 kΩ load impedance for current to flow making them compatible with the basic MM phono input found as standard on many integrated amplifiers. If your amplifier does not feature a MM phono input, these can be purchased separately at a reasonable cost.

The Goldring 2000 series offers a hierarchy of MI cartridges to complement your chosen performance level. From the entry-level up to the needs of the high end audiophile, but all with the signature Goldring sound.

Moving Magnet cartridge

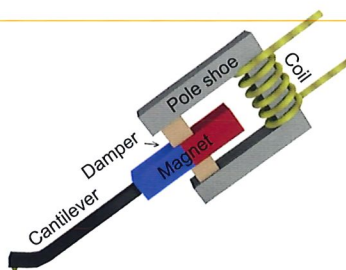

Moving Iron cartridge

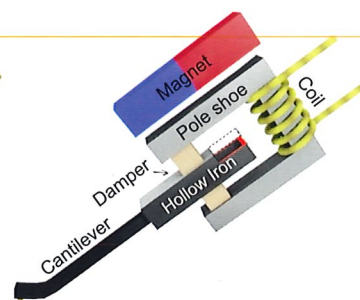

GOLDRING 2100



The 2100 features a bonded elliptical diamond stylus producing high frequency clarity and quality sound. The 2100 can be used to upgrade many budget turntables.

GOLDRING 2200



The 2200 features a bonded elliptical diamond stylus and alumite cantilever which offers higher definition and improved transient response when compared to a conventional cantilever and spherical stylus.

Frequency Response	20 Hz - 20 kHz +/- 3 dB
Channel Balance	within 2 dB @ 1kHz
Channel Separation	better than 20 dB @ 1 kHz
Sensitivity	6.5 mV ±1.5 dB, 1kHz @ 5 cm/sec
Static Compliance	35 mm/N
Dynamic Compliance	@ 10 Hz 16 mm/N
Vertical Tracking Angle	24°
Stylus Radius	Elliptical 0.7 x 0.3 mil
Stylus Type	Replaceable
Cantilever	Aluminium
Load Resistance	47 kΩ
Load Capacitance	100-200 pF
Internal Inductance	550 mH
Internal Resistance	550 Ω
Cartridge Mass	7.4 g
Cartridge Mass (incl. fixings)	8.6 g
Fixing Centre	12.7 mm (0.5")
Playing Weight	1.5 - 2.0 g (1.7 g nom.)

Frequency Response	20 Hz - 20 kHz +/- 3 dB
Channel Balance	within 2 dB @ 1 kHz
Channel Separation	better than 20 dB @ 1 kHz
Sensitivity	6.5 mV ±1.5 dB, 1 kHz @ 5 cm/sec
Static Compliance	35 mm/N
Dynamic Compliance	@ 10 Hz 16 mm/N
Vertical Tracking Angle	24°
Stylus Radius	Bonded Elliptical 0.7 x 0.3 mil
Stylus Type	Replaceable
Cantilever	Alumite
Load Resistance	47 kΩ
Load Capacitance	100-200 pF
Internal Inductance	680 mH
Internal Resistance	550 Ω
Cartridge Weight	7.4 g
Cartridge Mass (incl. fixings)	8.6 g
Fixing Centre	12.7 mm (0.5")
Playing Weight	1.5 - 2.0 g (1.7 g nom.)



G2000 SERIES

moving iron cartridges

GOLDRING 2300



By using an elliptical nude-diamond stylus, the 2300 offers high frequency clarity and excellent transient response due to its lower tip-mass compared to bonded types. This record cartridge will upgrade many mid-range turntables, allowing them to produce an even finer sound.

Frequency Response	20 Hz - 20 kHz +/- 3 dB
Channel Balance	within 2 dB @ 1 kHz
Channel Separation	better than 20 dB @ 1 kHz
Sensitivity	6.5 mV +/- 1.5 dB, 1 kHz @ 5 cm/sec
Static Compliance	35 mm/N
Dynamic Compliance	@ 10 Hz 16 mm/N
Vertical Tracking Angle	24°
Stylus Radius	Nude Elliptical
Stylus Type	Replaceable
Cantilever	Alumite
Load Resistance	47 kΩ
Load Capacitance	100 - 200 pF
Internal Inductance	680 mH
Internal Resistance	550 Ω
Cartridge Mass	7.4 g
Cartridge Mass (incl. fixings)	8.6 g
Fixing Centre	12.7 mm (0.5")
Playing Weight	1.5 - 2.0 g (1.7 g nom.)

GOLDRING 2400



The 2400 has a low-mass, "Vital" shank, nude diamond stylus and tapered aluminum cantilever for increased resolution. This polyhedral, line-contact profile has a very low tip-mass and a large contact area whilst being very narrow from front to back, enabling the accurate retrieval of even the highest frequencies in the recording.

Frequency Response	20 Hz - 20 kHz +/- 3 dB
Channel Balance	2 dB @ 1 kHz
Channel Separation	>20 dB @ 1 kHz
Sensitivity	6.5 mV +/- 1.5 dB, 1 kHz @ 5 cm/sec
Static Compliance	35 mm/N
Dynamic Compliance	@ 10 Hz 16 mm/N
Vertical Tracking Angle	24°
Stylus Radius	Vital
Stylus Type	Replaceable
Cantilever	Tapered Aluminium
Load Resistance	47 kΩ
Load Capacitance	100 - 200 pF
Internal Inductance	720 mH
Internal Resistance	550 Ω
Cartridge Mass	7.4 g
Cartridge Mass (incl. fixings)	8.6 g
Fixing Centre	12.7 mm (0.5")
Playing Weight	1.5 - 2.0 g (1.7 g nom.)

GOLDRING 2500



The 2500 uses a nude, square shank, natural diamond stylus in a diagonal orientation with a proprietary 2SD line-contact profile. The stylus only contacts the groove wall along the short radius ridges which are so fine that it can accurately trace details down to 4 microns – enough for replay of quadraphonic records.

Frequency Response	20 Hz - 20 kHz +/- 3 dB
Channel Balance	within 2 dB @ 1 kHz
Channel Separation	better than 20 dB @ 1 kHz
Sensitivity	6.5 mV +/- 1.5 dB, 1 kHz @ 5 cm/sec
Static Compliance	35 mm/N
Dynamic Compliance	@ 10 Hz 16 mm/N
Vertical Tracking Angle	24°
Stylus Radius	2SD
Stylus Type	Replaceable
Cantilever	Tapered Aluminium
Load Resistance	47 kΩ
Load Capacitance	100-200 pF
Internal Inductance	720 mH
Internal Resistance	550 Ω
Cartridge Mass	7.4 g
Cartridge Mass (incl. fixings)	8.6 g
Fixing Centre	12.7 mm (0.5")
Playing Weight	1.5 - 2.0 g (1.7 g nom.)

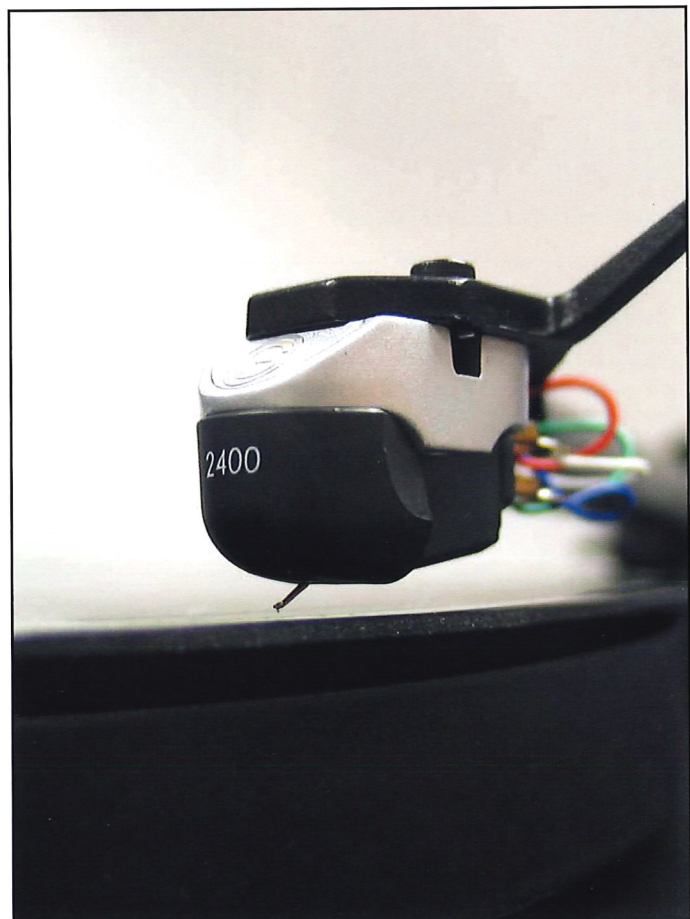



EROICA - ELITE - LEGACY

moving coil cartridges

EROICA H



The Eroica H is a true audiophile moving-coil cartridge designed to be used with any type of phono input. It features the famous Gyger II diamond stylus profile, a nude, fine-line elliptical type with a 6 µm lesser radius, which gives smooth, extended highs, low distortion and reproduces a highly detailed and dynamic sound. The pick-up coils are hand-wound on a pure iron armature and suspended in a magnetic circuit of advanced design, featuring low mass and powerful rare earth magnets.

Frequency Response	20 Hz - 22 kHz ± 3 dB
Channel Balance	within 1 dB @ 1 kHz
Channel Separation	better than 25 dB @ 1 kHz
Sensitivity	2.5 mV ± 1 dB, 1 kHz @ 5 cm/sec
Static Compliance	30 mm/N
Dynamic Compliance	@ 10 Hz 18 mm/N
Equivalent tip mass	0.6 mg
Vertical Tracking Angle	24 °
Stylus Radius	Gyger II
Stylus Type	Non-Replaceable
Load Resistance	47 kΩ
Load Capacitance	100 - 500 pF
Internal Inductance	0.2 mH
Internal Resistance	77 Ω
Cartridge Mass	5.5 g
Cartridge Mass (incl. fixings)	6.6 g
Fixing Centre	12.7 mm (0.5")
Playing Weight	1.5 - 2.0 g (1.7 g nom.)

EROICA LX



The Eroica LX moving-coil cartridge features the famous Gyger II diamond stylus profile. It reproduces a highly detailed and dynamic sound. The pick-up coils are hand-wound on a pure iron armature and suspended in a magnetic circuit of advanced design, featuring low mass and powerful rare earth magnets. The low output Eroica LX offers an exceptionally high standard of performance and reliability and must be used with an amplifier which features a dedicated moving coil phono input.

Frequency Response	20 Hz - 22 kHz ± 2 dB
Channel Balance	within 1 dB @ 1 kHz
Channel Separation	better than 25 dB @ 1 kHz
Sensitivity	0.5 mV ± 1 dB, 1 kHz @ 5 m/s
Static Compliance	30 mm/N
Dynamic Compliance	@ 10 Hz 18 mm/N
Equivalent tip mass	0.35 mg
Vertical Tracking Angle	24 °
Stylus Radius	Gyger II
Stylus Type	Non-Replaceable
Load Resistance	100 Ω
Load Capacitance	100 - 1000 pF
Internal Inductance	12 µH
Internal Resistance	8 Ω
Cartridge Mass	5.5 g
Cartridge Mass (incl. fixings)	6.6 g
Fixing Centre	12.7 mm (0.5")
Playing Weight	1.5 - 2.0 g (1.7 g nom.)

ELITE



The Elite is an ultra high-performance low-output moving coil cartridge which incorporates all of Goldring's most time-honoured design features. These include advanced magnetic circuitry with neodymium magnet and an ultra-rigid Pocan® body. The Elite incorporates a Gyger S line-contact nude diamond stylus, providing maximum groove information retrieval and an outstandingly smooth and extended frequency response. The Swedish iron armature is hand-wound with pure silver wire.

Frequency Response	20 Hz-30 kHz +/- 2 dB
Channel Balance	within 1 dB @ 1 kHz
Channel Separation	better than 25 dB @ 1 kHz
Sensitivity	0.5 mV +/- 1 dB @ 1 kHz
Static Compliance	30 mm/N
Dynamic Compliance	@ 10 Hz 18 mm/N
Equivalent tip mass	0.35 mg
Vertical Tracking Angle	20 °
Stylus Radius	Gyger S
Stylus Type	Non-Replaceable
Load Resistance	100 Ω
Load Capacitance	100 - 500 pF
Internal Inductance	2 uH
Internal Resistance	8 Ω
Cartridge Mass	5.7 g
Cartridge Mass (incl. fixings)	6.6 g
Fixing Centre	12.7 mm (0.5")
Playing Weight	1.5 - 2.0 g (1.7 g nom.)

LEGACY



The Legacy boasts an ultra low resonance magnesium metal body which is both very light and extremely strong. It has threaded inserts, allowing the cartridge to be easily mounted and aligned into the headshell. The stylus is a 'Vital' fine-line diamond, which is highly polished and gives extremely low distortion. The stylus attached to a hard alloy cantilever which transfers the maximum level of detail from the diamond to the coils; the latter are hand wound using only the highest purity copper.

Frequency Response	20 Hz-20 kHz +/- 3 dB
Channel Balance	within 2 dB @ 1 kHz
Channel Separation	better than 25 dB @ 1 kHz
Sensitivity	6.5 mV +/- 1.5 dB, 1 kHz @ 5 cm/sec
Static Compliance	20 mm/N
Dynamic Compliance	@ 10 Hz 10 mm/N
Equivalent tip mass	0.45 mg
Vertical Tracking Angle	24 °
Stylus Profile	Gyger S
Stylus Type	Replaceable
Load Resistance	47 kΩ
Load Capacitance	150-200 pF
Internal Inductance	570 mH
Internal Resistance	660 Ω
Cartridge Mass	6.3 g
Cartridge Mass (incl. fixings)	7.6 g
Fixing Centre	12.7 mm (0.5")
Playing Weight	1.5 - 2.0 g (1.7 g nom.)



ETHOS

moving coil cartridges

The Goldring Ethos is a top-of-the-range cartridge with outstanding sound reproduction capabilities, designed and hand-built in the United Kingdom. By using a top quality Vital line-contact diamond stylus, the Ethos has an exemplary ability to retrieve every last ounce of detail from the record groove. The high channel separation reproduces an exceptionally accurate and realistic stereo sound stage. At the same time the enhanced trackability and absence of colouration delivers undiluted enjoyment of the music.

Inside the Ethos

At the heart of the Ethos cartridge is Goldring's hand-built GOL-1 moving-coil generator. Developed in the heyday of vinyl, it takes advantage of a lower coil inductance and reduced effective mass when compared to traditional moving magnet types to give a smooth, extended frequency response with enhanced trackability.

For Ethos, we have carefully improved numerous aspects of its design and assembly to further enhance its world class reputation. With modern set-up and test equipment at their disposal, our UK based expert craftsmen are able to precisely build and individually adjust each cartridge so that it is capable of retrieving every last detail from the record groove.

The result is that one becomes simply immersed in the musical experience... And that's our whole Ethos.

"Ethos: Goldring's most advanced moving coil cartridge, for unparalleled performance"

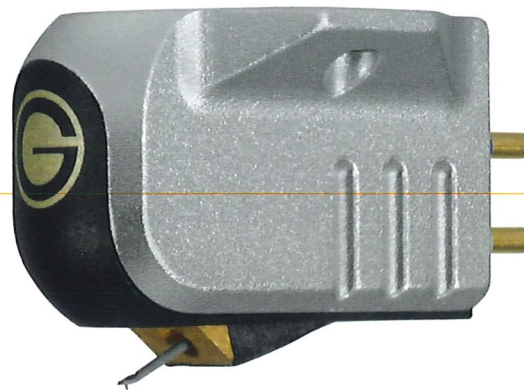
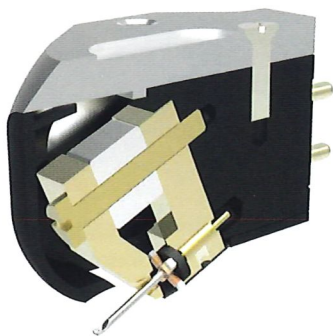

Stylus profile	Vital line-contact
Cantilever	Aluminium alloy
Replacement stylus	Factory replaceable
Frequency range	10 Hz - 32 kHz
Frequency response	± 2 dB (35 Hz - 20 kHz)
Channel balance	<1 dB at 1 kHz
Channel separation	>30 dB at 1 kHz
Sensitivity	0.5 mV ± 1 dB @ 1 kHz, 5 cm/s (rms)
Static compliance	25 mm/N
Dynamic compliance	15 mm/N
Vertical tracking angle	20°
Load resistance	100 Ω
Load capacitance	100 - 1000 pF
Internal inductance	7.5 µH
Internal resistance	4 Ω
Cartridge mass	7.7 g
Total mass (incl. fixings)	8.5 g
Fixing centres	12.7 mm (0.5 in)
Playing weight	1.5 - 2.0 g (1.75 g)



Line-Contact Stylus

The line-contact diamond profile provides a large contact area with the groove wall, improving the retrieval of high frequency detail and reducing groove wear. Its vital-shaped shank has a low tip mass giving the design exceptionally good trackability.

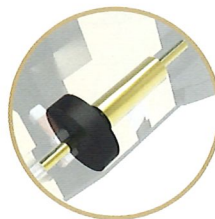

Optimised Suspension

The new damper pad uses a bespoke butyl rubber compound to keep the system critically damped. Combined with an expertly tensioned tie-wire, the cartridge remains ultra-stable even during the loudest and most complex passages.

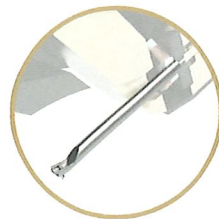

Alloy Cantilever

The stiff and lightweight alloy cantilever tube has been tuned to the ideal length for cartridge stability and ride height. Its length has been optimised to reduce inertia in the suspension system and improve trackability.

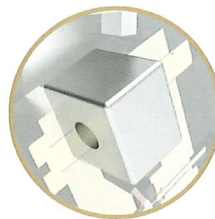

Neodymium Magnet

A very light and powerful neodymium magnet is clamped between two pole shoes creating a perfectly uniform magnetic field gap, within which the cross armature is suspended. This gives Ethos its typically flat and extended frequency response.

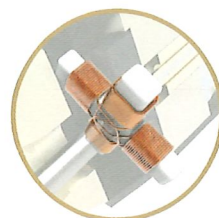

Cross-Shaped Armature

The coils are wound around a cross-shaped armature of pure, high-permeability, Swedish iron. The reduced unsprung mass improves the ability for the stylus to track the groove wall and the coil separation minimises cross-talk, improving the stereo image.



Aluminium Body Shell

The body is precision-milled from a low density, rigid, aircraft grade aluminium which helps to maintain a low effective mass and enables it to dissipate unwanted resonances into the tonearm where they are effectively 'grounded'.



Goldring, established in 1906, has been a pioneer in the field of high quality recorded musical reproduction for more than 100 years. The company's history began with the manufacturing of clockwork motors, springs and steel needles to the gramophone industry. Products were marked with a golden ring to indicate high quality of design and manufacture. This expertise was utilised in the 1920's for the production of Goldring Soundboxes and later, electro-magnetic gramophone pick-ups. Goldring is widely regarded as one of Europe's stellar audio equipment manufacturers. It is the only British manufacturer of audiophile performance phonograph cartridges.

Goldring cartridges are designed and built by British craftsmen at a modern factory in Hertfordshire (UK). The company uses its accumulated experience and knowledge to design and produce a range of technically advanced and musically adept cartridges at a wide range of prices, from the inexpensive to the exquisite. All cartridges undergo rigorous testing to ensure that each will deliver superb performance and reliability.

Goldring is exclusively represented by Tonar International for distribution in The Netherlands, Belgium and Luxembourg. Since 1954, Tonar has become the specialist for analogue audio, phonograph styli, cartridges and accessories for your turntable and vinyl collection.

Your Goldring dealer:

TONAR International B.V. - Beeldschermweg 5 unit 1 - 3821 AH Amersfoort - The Netherlands
Phone: +31 33 - 455 45 11 - Fax: +31 33 - 456 05 44 - E-mail: info@tonar.eu - www.tonar.eu





NAGAOKA

www.nagaoka.eu

*Styli, cartridges and accessories
with the authentic vinyl sound*

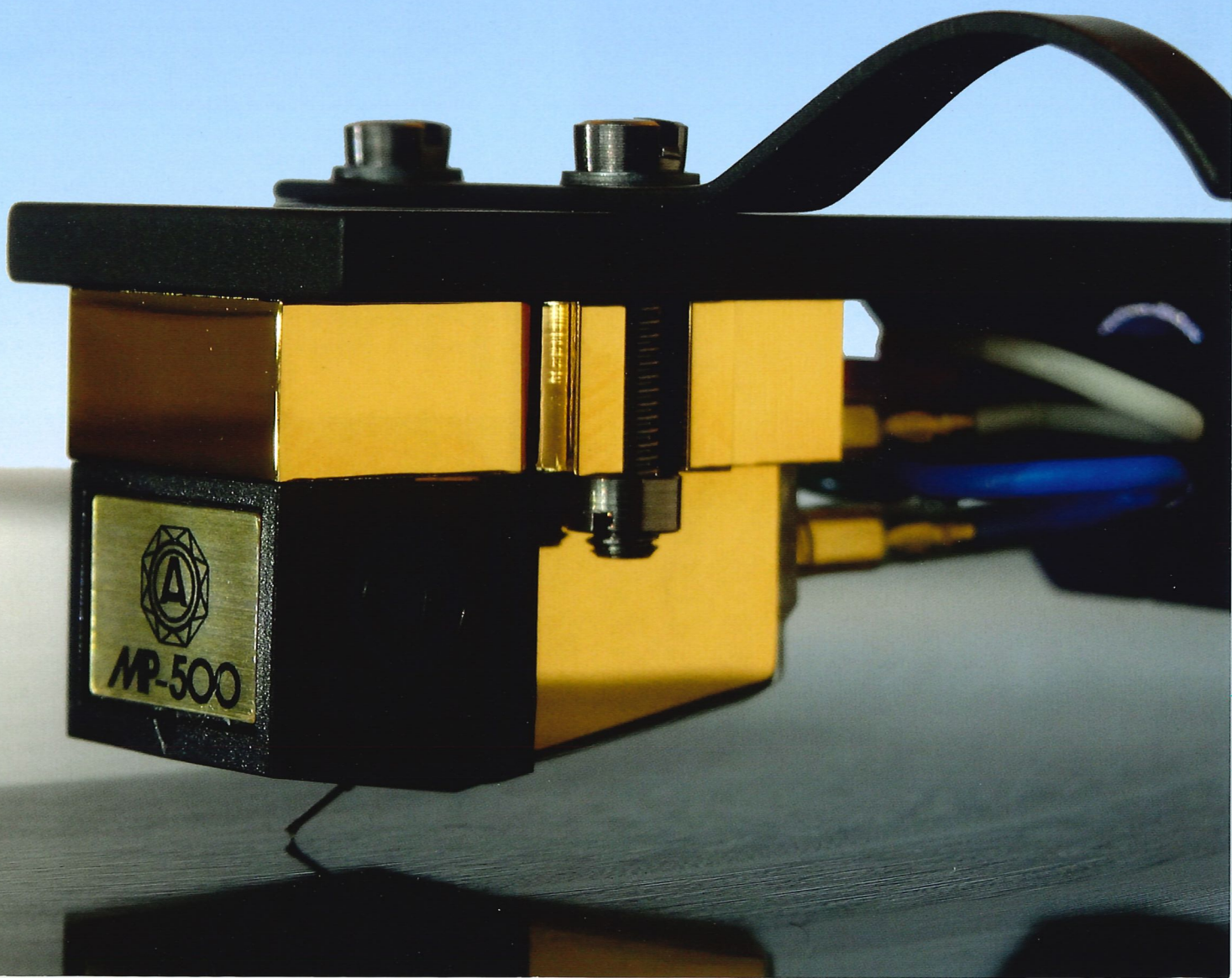

NAGAOKA

Nagaoka is unique in the cartridge business having produced styli, cartridges and accessories for records since 1940. Nagaoka has endeavoured manufacturing styli and pick-up cartridges of the best possible quality to satisfy the expectations of true vinyl connoisseurs — bringing the highest musical and creative expression from the concert hall to the comfort of your home.

Through its long track record in the field of phonograph technology, Nagaoka has perfected the stylus manufacturing technologies and continues to develop new innovative solutions to improve a full audio experience. Each Nagaoka phono cartridge is produced with precision craftsmanship, stringent quality control, careful assembly and thorough inspection. Nagaoka is the world's only cartridge producer that manufactures all high precision parts of the cartridge in its own factories: from the diamond tips, the cantilevers and the samarium cobalt magnets, to even the coils.

As we share a passion for analogue sound reproduction, Nagaoka helps to provide you with all essential tools — from hi-fi styli and cartridges to accessories for sound enhancement and record cleaning — so you can enjoy the authentic vinyl sound.



tonar

Nagaoka is exclusively represented in Europe by Tonar International. Both companies share a long history of fruitful cooperation, that goes back to Tonar's foundation in 1954. Ever since, Tonar has become the specialist for phonograph styli, cartridges and accessories for your turntable and vinyl collection.

WWW.NAGAOKA.EU

Nagaoka presents:

The phonograph cartridge is perhaps the most important component of your whole vinyl sound system. The cartridge converts the vibrations of the stylus into audio signals. The quality and shape of the stylus and the tolerances in the manufacturing process are of the utmost importance to ensure that the translation of the information in the grooves is perfect and no sound is lost or noise is added in the process.

The high performance Nagaoka MP (Moving Permalloy) cartridge line incorporates the most state-of-the-art materials. The cartridges of the MP Series provide an equal sound reproduction in all frequency ranges: from the super deep low tones to the crystal clear high notes. The MP-cartridges clearly accentuate and separate every detail — however small — of the musical instruments and voices of the artists.

An oscillation system aimed at perfect tracking capability

Central to the high performance of the Nagaoka MP Series is the development of an oscillation system that perfectly captures the information engraved in the grooves of the record. Originally, in order to transform the vibrations of the stylus into soundwaves, a cartridge makes use of two essential components: a moving magnet and fixed coils. As the stylus tracks the record groove, the modulations of the groove move the stylus back and forth and up and down. The stylus in turn moves the cantilever, which moves the magnet attached to its opposite end, which ultimately creates a current in the fixed coils located in the cartridge body that is sent to the (pre)amplifier.

The way MP cartridges work is slightly different. Instead of a real magnet at the opposite end of the cantilever there is Permalloy material (a nickle-iron alloy). This material is not a magnet itself, but in the field of a powerful magnet it acts as if it were a magnet — we

***Nagaoka is the world's only
cartridge producer that
manufactures all high precision
parts of the cartridge in its own
factories: from the diamond tips,
the cantilevers and the samarium
cobalt magnets, to even the coils.***

Cartridge Series

call it Induced Magnet or IM (also known in some cartridge models as moving Iron). The fixed Samarium Cobalt magnet in the cartridge body activates this magnetic property in the Permalloy and so the coils in the cartridge see a "moving magnet". The big advantage of the MP-cartridges is that the Permalloy material is substantially lighter in weight than a real magnet and so the moving mass of the tip-cantilever-Permalloy combination is considerably lower, making it much easier for the combination to follow the modulations in the groove accurately.

Samarium cobalt magnet

The MP-cartridges are equipped with a fixed samarium cobalt magnet. This magnet has an extremely powerful magnetic field, much stronger than any other type of magnet. The weight of this magnet in comparison to the power is much smaller than other magnets reducing the weight of the cartridge considerably and enabling the magnet to be mounted much closer to the Permalloy tip of the cantilever. By reducing the distance less magnetic energy will be lost, which has a very positive effect on the sound quality.

The stylus tip and the cantilever

Since its founding, Nagaoka has developed a strong track record on precision processing and microfabrication of difficult-to-cut materials such as sapphire and diamond. The MP-series cartridges have a low mass naked diamond tip (except

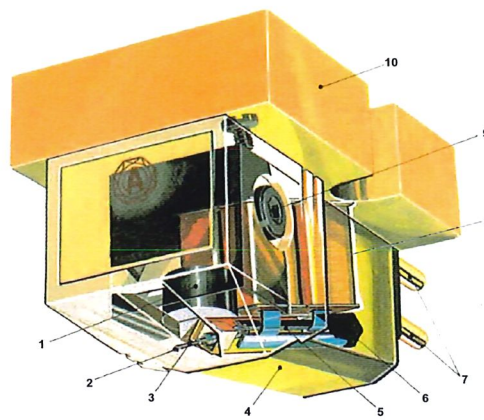

- ① Samarium cobalt magnet
- ② Stylus tip
- ③ Cantilever
- ④ Shield case
- ⑤ Permalloy oscillator
- ⑥ Cylinder
- ⑦ Gold plated terminal pins
- ⑧ Coils
- ⑨ Anti-resonance screw
- ⑩ Housing

for the MP-100 and MP-110 which have a light weight bonded diamond tip), which is only one third of the mass of conventional diamond tips. It is manufactured by super fine particle grinding, based on extended stylus technology.

The cantilever is designed with a unique hollow construction, fabricated with high precision at the micro-world level. Since high rigidity is essential for a cantilever, Nagaoka has selected the most light-weight and strong materials. The MP-500, the MP-300 and the MP-200 have a cantilever made out of Boron, a material that is ultra-light weight, extremely rigid and more durable than granite, beryllium or carbon fibre. The MP-150 has a hardened tapered aluminum cantilever which is more rigid than normal aluminum cantilevers because of its shape. The rigid cantilever of the MP-cartridges ensures an even and distortion free sound reproduction.

Avoiding unnecessary resonance

Every material used for the production of the MP-cartridges has been critically

selected to eliminate unnecessary resonance. The frame of the cartridges is made from high purity aluminum, which is light in weight and has a high physical strength. Because of its even density, sound distortion caused by vibration of the frame body is minimal. In addition, the replaceable stylus and the bodies of the MP-500 and MP-300 have been completely tightened with a special screw. This eliminates the occurrence of resonance of the plastic knob of the replaceable stylus.

Due to Nagaoka's dedication to precision craftsmanship and their continuous pursuit of perfect sound reproduction, the MP-line will not fail to provide you with the best musical satisfaction. With these *Master Piece* cartridges, Nagaoka invites you to enjoy your record collection in excellent audio quality with vivid, colourful and dimensional clarity and detailed sound.

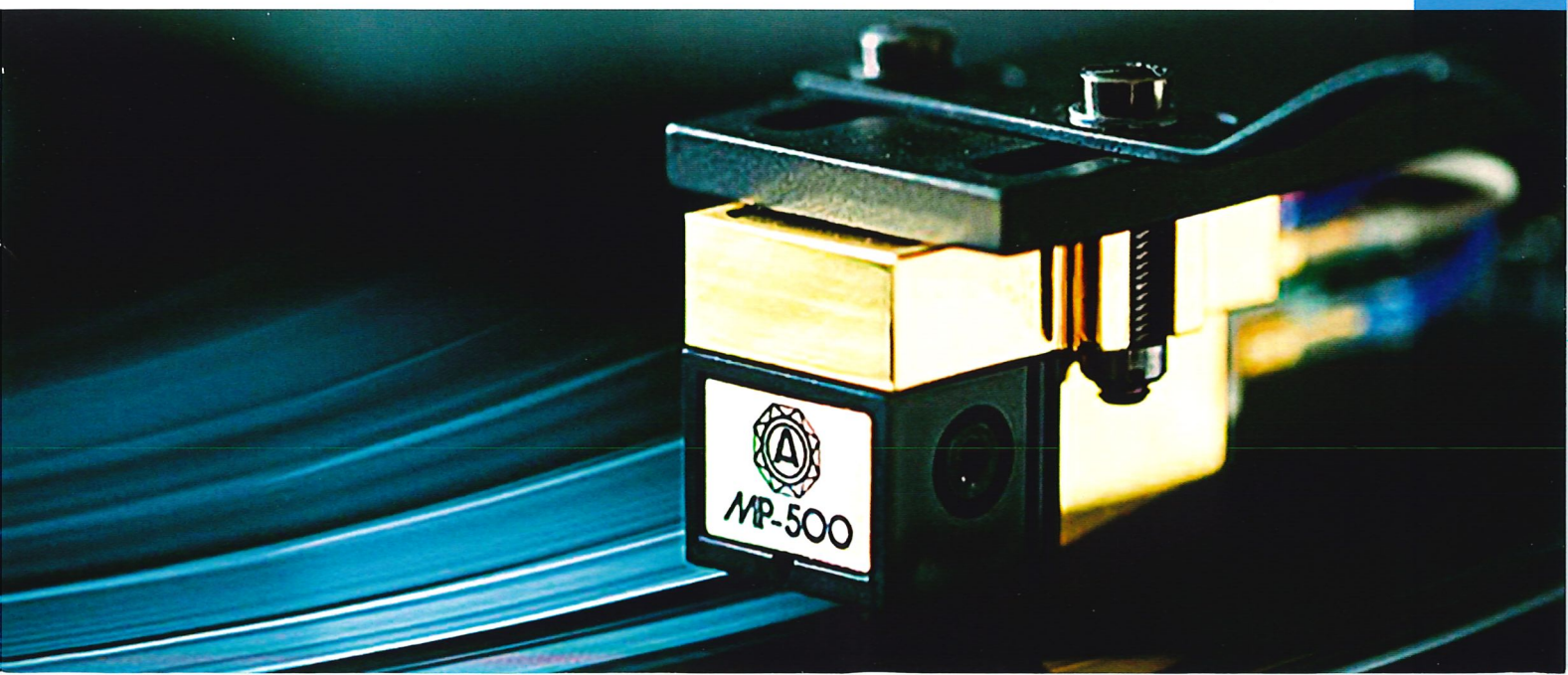

NAGAOKA MP-500

The MP-500 is Nagaoka's top-of-the-line phonograph cartridge. It offers the finest audio experience of the MP-series. The cartridge features an exclusive super-rigid body for ultra low resonance and superlative fidelity with a fine polished line contact diamond stylus. Its characteristics include a powerful samarium cobalt magnet, low-mass high-strength rigid boron cantilever, carbon fiber reinforced plastic shoe and anti-ferro magnetic permalloy shield casing. The MP-500 plays your records with image solidity, detailed resolution, and bass extension.

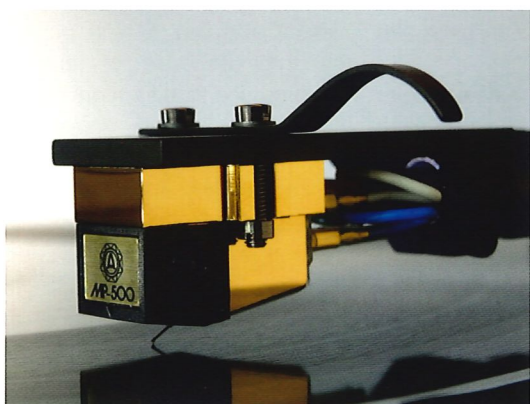
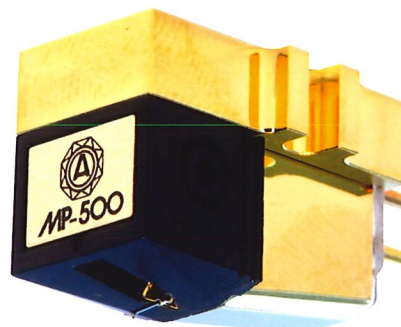

Output Voltage	3,0 mV (5 cm/sec)
Frequency characteristics	20-25.000 Hz
Channel Separation	27 dB (1 KHz)
Channel balance	1.0 dB or less
Load resistance	47 K Ω
Cantilever	Boron
Stylus tip shape/radius	Line contact
Stylus tip material	naked diamond
Stylus pressure	1,3 – 1,8 g
Cartridge weight	8,0 g

- [Tonar article no. 9353](#)
- [Tonar article no. 9401 \(premounted in headshell\)](#)

NAGAOKA MP-300

The Nagaoka MP-300 is an advanced technology cartridge that features a special elliptical diamond mounted on a boron cantilever for superior record groove retrieval. It offers harmonically accurate and excellent rendition of voice and music. As such, the MP-300 stands for sophistication, refinement and high-definition at all audible frequencies to be easy on the ears.

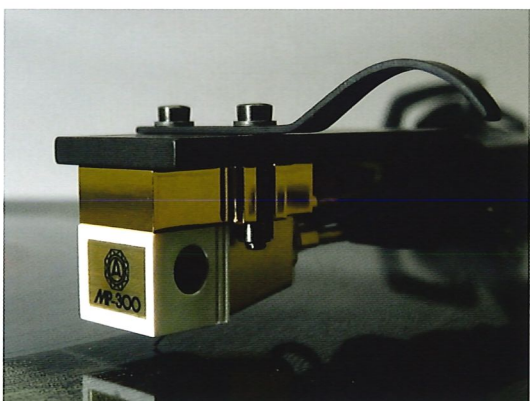

Output Voltage	3,0 mV (5 cm/sec)
Frequency characteristics	20-25.000 Hz
Channel Separation	25 dB (1 KHz)
Channel balance	1.0 dB or less
Load resistance	47 K Ω
Cantilever	Boron
Stylus tip shape/radius	0.4 x 0.7 mil elliptical
Stylus tip material	naked diamond
Stylus pressure	1,3 – 1,8 g
Cartridge weight	8,0 g

- [Tonar article no. 9351](#)
- [Tonar article no. 9399 \(premounted in headshell\)](#)

NAGAOKA MP-200

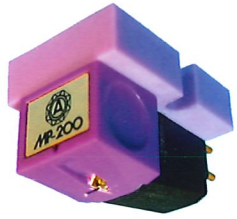

The Nagaoka MP-200 is a cartridge of musical contrasts. On the one hand, it offers an organic, fluid presentation with an engaging midrange reproduction of vocals and instruments. On the other hand, it retains the detail, lustre, dynamics and presence of music that are so often buried and attenuated by smooth sounding cartridges.

Output Voltage	4,0 mV (5 cm/sec)
Frequency characteristics	20-23.000 Hz
Channel Separation	25 dB (1 KHz)
Channel balance	1.5 dB or less
Load resistance	47 K Ω
Cantilever	Boron
Stylus tip shape/radius	0.4 x 0.7 mil elliptical
Stylus tip material	naked diamond
Stylus pressure	1,5 – 2,0 g
Cartridge weight	6,5 g

- Tonar article no. 9349
- Tonar article no. 9397 (premounted in headshell)

NAGAOKA MP-150



The Nagaoka MP-150 phono cartridge gives a fine solid bass, superb fluidity across the frequency spectrum, and sweet highs. To an artful listener who aspires for warm and accurate eloquence the Nagaoka MP-150 will be an endearing and lasting treasure.

Output Voltage	4,5 mV (5 cm/sec)
Frequency characteristics	20-20.000 Hz
Channel Separation	24 dB (1 KHz)
Channel balance	1.5 dB or less
Load resistance	47 K Ω
Cantilever	hardened tapered aluminum alloy
Stylus tip shape/radius	0.4 x 0.7 mil elliptical
Stylus tip material	naked diamond
Stylus pressure	1,5 – 2,0 g
Cartridge weight	6,5 g

- Tonar article no. 9347
- Tonar article no. 9395 (premounted in headshell)

NAGAOKA MP-110

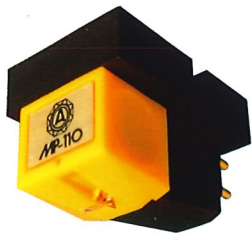

The Nagaoka MP-110 cartridge is world famous for its outstanding sound performance. Tracking and bass impact of this cartridge are exceptional, no matter if you are listening to classical music or rock, with everything in-between. The MP-110 has been selected by many leading high-end manufacturers for standard mounting in their turntables.

Output Voltage	5,0 mV (5 cm/sec)
Frequency characteristics	20-20.000 Hz
Channel Separation	23 dB (1 KHz)
Channel balance	1.5 dB or less
Load resistance	47 K Ω
Cantilever	aluminum alloy
Stylus tip shape/radius	0.4 x 0.7 mil elliptical
Stylus tip material	bonded diamond
Stylus pressure	1,5 – 2,0 g
Cartridge weight	6,5 g

- Tonar article no. 9345
- Tonar article no. 9393 (premounted in headshell)

NAGAOKA MP-100

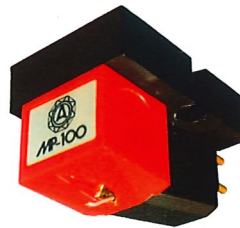

The entry level Nagaoka MP-100 phono cartridge offers musical clarity and expression beyond its price - a splendid upward start toward long term musical enjoyment with the fine quality of Nagaoka.

Output Voltage	5,0 mV (5 cm/sec)
Frequency characteristics	20-20.000 Hz
Channel Separation	22 dB (1 KHz)
Channel balance	2.0 dB or less
Load resistance	47 K Ω
Cantilever	aluminum alloy
Stylus tip shape/radius	0.6 mil spherical
Stylus tip material	bonded diamond
Stylus pressure	1,8 – 2,3 g
Cartridge weight	6,5 g

- Tonar article no. 9343
- Tonar article no. 9391 (premounted in headshell)

NAGAOKA 78 RPM styli series

assorted tip sizes for improved playback of Shellac records

The generally accepted tip radius for playback of 78 RPM records is 3.0 mil (0.003 inch). Due to the playback in the past of these very old records with very high stylus pressure and often with steel needles a lot of damage has been made to the grooves. This damage is the cause of a lot of distortion and background noise. Sometimes better results can be achieved by playing the record either on a lower part or a higher part of the groove which may have been damaged less than the damage found on the average playback height. To play-back at a higher level in the groove, use either the 3.5 mil or the 4.0 mil tip. To playback at a lower groove level use either the 2.0 mil, or 2.5 mil tip. When you have found the best height affix a sticker to the record so you will know the next time which stylus tip to use for best results.

MP - 1.0

■ Tonar article no. 6837



MP - 2.0

■ Tonar article no. 6839



MP - 2.5

■ Tonar article no. 6845



MP - 3.0

■ Tonar article no. 6835



MP - 3.5

■ Tonar article no. 6841



MP - 4.0

■ Tonar article no. 6843



NAGAOKA DJ-03HD

DJ cartridge for scratching

The Nagaoka DJ-03D is designed with precision for excellent skip resistance. This powerful cartridge ensures a continuous connection to the record during even the most energetic scratch performances. The fluorescent tip makes it easy for the DJ to put the stylus in the desired part of the groove. The cartridge is premounted in a SME connection type DJ headshell and fits directly onto the arm of the Technics SL-1200 DJ type turntables and its clones. The inside of the DJ-03D cartridge has been incorporated into a number of private label cartridges by well known DJ turntable manufacturers.

Output Voltage	6,0 mV (5 cm/sec)
Frequency characteristics	20-20.000 Hz
Channel Separation	20 dB (1 KHz)
Channel balance	1.5 dB
Load resistance	47 KΩ
Cantilever	aluminum alloy
Stylus tip shape/radius	0.6 mil conical
Stylus tip material	bonded diamond
Stylus pressure	3 – 5 g
Cartridge weight	5,2 g



■ Tonar article no. 9502 (premounted in SME connection type DJ headshell)

NAGAOKA Hi Clean AM-801

stylus cleaning fluid

Your phonograph stylus also needs cleaning and care. Due to air pollution caused by both outside influences (traffic exhaust fumes) and domestic influences (kitchen, fumes and smoking) a sticky film is deposited over time on to your records. During playback the stylus will scrape this deposit from the groove which in turn causes a sticky film to form around the stylus tip. This grime traps other dirt and dust found on your record. This easily visible thick deposit not only influences the quality of the sound, but if allowed to build up further, may even cause the stylus to jump out of the groove and to do damage to your favourite records. The special formula of the Nagaoka AM-801 efficiently dissolves all the sticky substance caught on the stylus and removes this as well as all the dirt trapped.

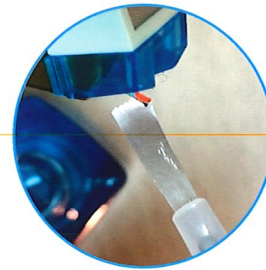

■ Tonar article no. 3281

NAGAOKA Cartridge Mounting Screws

assorted packs of cartridge screws and nuts

BN-7b (black)

BN-7s (aluminum)



Screw Sizes and Quantity:

M2.6 x 3mm	- 4x
M2.6 x 6mm	- 2x
M2.6 x 8mm	- 2x
M2.6 x 10mm	- 2x
M2.6 x 12mm	- 2x
M2.6 x 14mm	- 2x
M2.6 x 18mm	- 4x
M2.6 Nut	- 4x
Nylon Washer	- 4x

■ Tonar article no. 3085

■ Tonar article no. 3084

NAGAOKA Rolling Cleaner CL-1000

silicone record cleaning roll

Conventional record cleaners attempt to wipe away the dust and dirt. The Nagaoka Rolling Cleaner uses a special grade of silicone rubber-elastomer which has the property that it's sticky. Just rolling over the record surface while applying a little pressure is enough to remove all dust and dirt in the grooves. The very soft silicone rubber will deform and take the shape of the record groove, being able to clean even the hard-to-reach bottom of the groove. The silicone rubber literally sticks to the dust and dirt like a limpet and any dust particles will be removed.

When the roll has become dusty, simply wash it under tap water using a little hand soap. The dust will easily be rinsed off. After drying the roll with lint free paper, it will become just as sticky as when it was new. There is no danger that you will damage the label when rolling over the complete record. Important! Always roll in straight lines over the grooves and the record label and do not attempt to follow the grooves in curves as this could do irreparable damage to the silicone rubber.

■ Tonar article no. 5929



NAGAOKA Recopack DC-203

record cleaning system



The Nagaoka Recopack is a cleaning system for very dirty records. A special syrup is distributed on the record using the supplied dispenser. A removal tag is placed on the edge of the record, halfway, in the still fluid syrup. Then the syrup is allowed to dry into a film during 24 hours. Once the film is dry you can remove it carefully by lifting the tab. All parts that do not belong to the record are now trapped in the film, even residue from previous use of for instance Lenco clean fluid.

■ Tonar article no. 3114

NAGAOKA Argento CL-118

velvet record cleaning brush

The Nagaoka Argento record brush uses the finest velvet available on the market and comes with a compact storage container and a built-in brush cleaner. The velvet reaches deep into the grooves and removes even the smallest dust particles.

■ Tonar article no. 5534



NAGAOKA RS-LP II (formerly Discfile No: 102)

the improved Nagaoka 25 micron anti-static record sleeves



Paper sleeves leave dust on the record and poly ethylene sleeves cling to the record. When removing the record from the sleeve, the polyethylene generates static charge which attracts the sleeve to the record and causes the dust caught between the sleeve and the record to scratch the record. The Nagaoka RS-LP II new improved version of the world famous Nagaoka Discfile no: 102 is anti-static and super slippery thus leaving the record completely unharmed.

■ Tonar article no. 3073



NAGAOKA 108/3

jacket cover for LP albums

Protect your valuable record albums covers from dust, grease and scratches with these Nagaoka outer sleeves. Nagaoka album covers for LP albums are supplied in packs of 10.

■ Tonar article no. 4643



NAGAOKA JC 30 LP

improved outer-sleeves for LP albums

With a thickness of 100μ, these improved Nagaoka strong outer-sleeves protect your important record album covers from scratches greasy fingers and dust.

Dimensions: 325 mm in width × 325 mm in height. Supplied in packs of 30.

■ Tonar article no. 5540



NAGAOKA Audio Isolators

combining Ruby with metal for better isolation

The Nagaoka Audio Isolators isolate your audio equipment from unwanted vibrations in the room, hence reducing the effect of acoustic feedback. As one of the cardinal gems, the Ruby is the only crystal material which is close to the hardness of the diamond. As such, the Ruby gem used in the Audio Isolators helps to suppress resonance and avoid vibrations. The Audio Isolators are available in two combinations: Ruby & Stainless Steel (INS-SU01) and Ruby & Brass (INS-BR02). When the product is installed, the Ruby gem remains visible, providing a luxurious feeling due to the contrast between the metallic lustre and the ruby gloss.

Isolator INS-SU01

■ Tonar article no. 4368



Isolator INS-BR02

■ Tonar article no. 4370



NAGAOKA Disc Stabilizer

record weight

The Nagaoka Disc Stabilizer, made from stainless steel, ensures a good contact between the record and the turntable platter. Pressing the record during playback will temporarily flatten warped records. In addition, the sound will improve, as unwanted resonances are suppressed and the grooves can be traced more accurately. Dimensions: 74 mm diameter x 22 mm. Caution: Please ensure that the platter bearing of your turntable is able to accept the additional weight of 600 grams. If in any doubt, please consult your record player instructions or your dealer.

■ Tonar article no. 5539



NAGAOKA 45 RPM Aluminum Adaptor

record adaptor

This record adaptor has been designed to be used with your 45 RPM records that no longer have the centres in them enabling you to play your old favourites.

■ Tonar article no. 3031



NAGAOKA In-Ear Headphones

world's first in-ear headphones using Ruby in the acoustic filter

Nagaoka is famous for its high precision processing and micro fabrication for difficult-to-cut materials. Now, Nagaoka has applied the red coloured Ruby in the acoustic filter of the in-ear headphones.

Ruby is a material of high hardness and is able to suppress internal resonance and compensate for the low frequencies. The special design makes the Ruby on the inside visible from the outside. In addition, these in-ear headphones are equipped with a one pole-type balanced armature for the speaker unit. This results in a multi dimensional sound, with excellent resolution, detail and sensitivity.

R1SV (silver)
■ Tonar article no. 5541

R1BK (black)
■ Tonar article no. 5542



Specifications

Unit type:	balanced armature x 1
Sensitivity:	113 dB / 1 kHz / 1 mW
Frequency range:	4 - 90.000 Hz
Input power:	20 mW
Impedance:	31 Ω
Weight:	8 g
Input Connector:	L type Φ3.5 mm(1/8") Gold-plated
Cable:	1.2m Silver-plated 4N-OFC
Included accessories:	Silicon ear pieces(S,M,L) COMPLY™ form ear pieces(T-400 L) Real leather Carrying pouch Ear wax filter replacement parts Instruction Manual

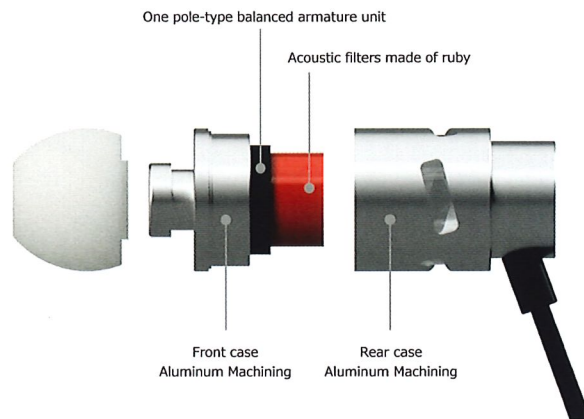

NAGAOKA x TENDO HPS-1K

original headphone stand made of Japanese Keyaki wood

In close cooperation with the renowned Japanese furniture maker Tendo Mokko, Nagaoka has designed a headphone stand made of molded Japanese keyaki wood (zelkova). This luxury stand is completely produced by hand and combines a touch of smoothness with refined elegance. Tendo has been one of the first companies in Japan to use formed plywood to mass-produce good-quality furniture. Tendo has collaborated with top architects and designers worldwide to create the most complicated curved lines with natural wood.

Size: 127 mm (w) x 157 mm (d) x 350 mm (h)
Weight: 520 g.



■ Tonar article no. 5543



NAGAOKA

www.nagaoka.eu

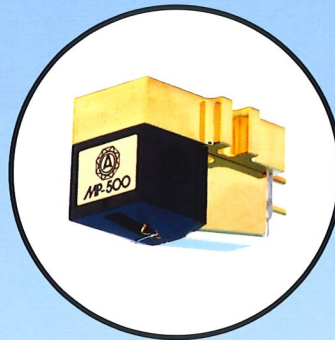

Your Nagaoka dealer:

Nagaoka is exclusively represented in Europe by:

TONAR International B.V. - Beeldschemweg 5 unit 1 - 3821 AH Amersfoort - The Netherlands
Phone: +31 33 - 455 45 11 - Fax: +31 33 - 456 05 44 - E-mail: info@nagaoka.eu - www.nagaoka.eu

JICO®

NIPPON PRECISION JEWEL INDUSTRY CO., LTD.



 Super Analog Stylus Series

SETO-HORI 瀬戸彫



The JICO Super Analog Stylus (SAS) is a state-of-the-art replacement stylus, using sophisticated precision technology to improve the analog sound experience for audiophiles. The SAS shape allows the stylus to reach the elusive parts of the grooves, while minimizing friction and record wear.

The SAS tip

The tip of the SAS is carefully chosen from single-crystal natural diamonds and is laser-cut with the most advanced electronic engineering technology. The SAS is designed to resemble the cutting stylus used to produce the master discs for vinyl record reproduction. This enables the SAS to have an optimal fit in the groove, which leads to less distortion at a high amplitude during playback.

The SAS offers the optimum tip design for accurate tracking of high-frequency passages. Variations in the size and shape of the stylus tip affect the amount of surface area which can be applied to the groove wall. By optimizing its curvature and reducing the minor radius, the SAS tip maximizes the contact surface area by a factor of 1.25 in comparison to other line contact styli. This allows the SAS to reproduce a more expansive bandwidth of information with higher fidelity. Hence, the SAS is able to retrieve details which were previously inaccessible to other styli.

The curvature of the tip shape is optimized to distribute effective mass, thereby eliminating excess pressure on the record groove wall and reducing distortion introduced by uneven wear. In addition, world-class polishing techniques are applied on each stylus, to further preserve the details of the record groove structure and to extend the life of the stylus with minimum abrasion.

■ The relation between stylus tip shape and contact surface

	Point contact stylus		Line contact stylus
	Conical Stylus 0.7 mil	Elliptical stylus 0.3 x 0.7 mil	S.A.S. stylus
Front view			
Cross-sectional view			
Contact with records			
Contact surface	23.4 μm ²	20.6 μm ²	62.1 μm ²
L ₁ / L ₂	1	1.8	9



The SAS cantilever

In order to transmit vibrations from the stylus tip to the transducer magnet faithfully, the cantilever of the SAS is supported by a specially constructed suspension. A single strand of ultra-fine piano wire is attached to the cantilever which then passes through the magnet before being secured internally to the housing. This helps to stabilize the movement of the magnet and reduce distortion from resonance that builds up as oscillations are transmitted through the cantilever, thus preserving the original signal down to the smallest detail.

To extract the maximum performance from the single point tension wire a specially shaped magnet is mounted coaxially to the cantilever. The magnet is composed of rare earth elements. The magnetic strength and reduced weight give it exceptional properties for transmitting the audio signals from the record groove.

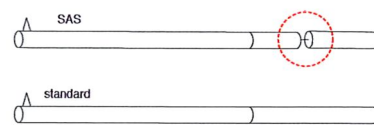

Tension wire controls the movement of the cantilever and the tip

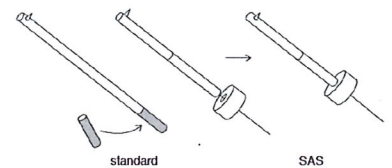

Specially formed rare earth magnet

Boron, Sapphire and Ruby

The cantilever of the SAS comes in three versions: boron (B-SAS), sapphire (S-SAS) and ruby (R-SAS).

Boron is one of the most suitable materials for cantilevers. Its density is low, it is very stiff and the speed of sound propagation is approximately 2.6 times faster than that of aluminium. Due to these characteristics, a boron cantilever can trace the information contained in the record grooves more precisely than aluminium cantilevers.

Sapphire has a high rigidity, which enhances the reproducibility of the sound engraved on analog records. Compared to aluminium cantilevers, every single sound will be defined more clearly, allowing the users to enjoy a crystal-clear sound.

Ruby enjoys all the benefits of the sapphire cantilever with one crucial advantage: the four facets of the crystalline ruby cantilever taper toward the diamond tip. This tapered ruby cantilever design allows for lower moving mass, giving even greater ability to reproduce vibrations in the record groove with precision, accuracy, speed and fidelity.



B-SAS boron cantilever



S-SAS sapphire cantilever



R-SAS ruby cantilever

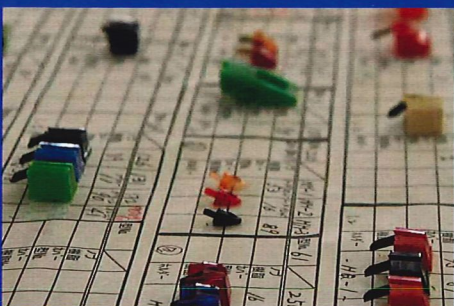
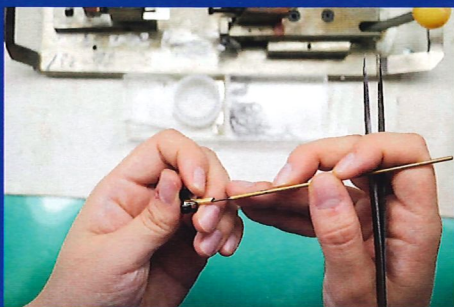
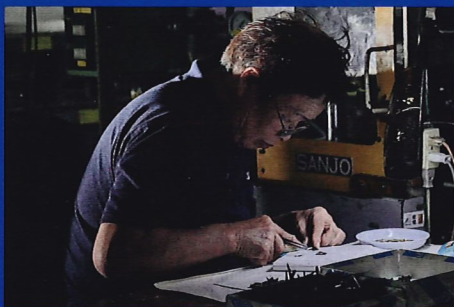
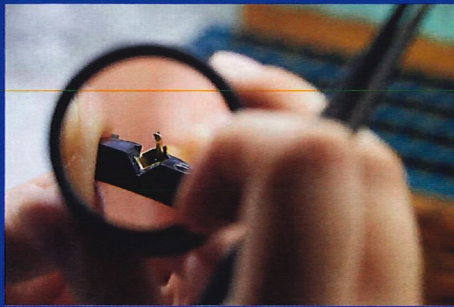

Super Analog Stylus Series

JICO®

NIPPON PRECISION JEWEL INDUSTRY CO., LTD.

Tonar no.:	Replacement stylus for:	Cantilever type:
6526 B-SAS	Elac D-793SH	Boron cantilever
6533 B-SAS	National/Technics EPS-30 ES	Boron cantilever
6537 B-SAS	National/Technics EPS-202 ED	Boron cantilever
6534 B-SAS	National/Technics EPS-205 CEX	Boron cantilever
6535 B-SAS	National/Technics EPS-205 ED	Boron cantilever
6531 B-SAS	National/Technics EPS-270 ED	Boron cantilever
6553 B-SAS	Philips GP-400 I	Boron cantilever
6554 B-SAS	Philips GP-400 II	Boron cantilever
6555 B-SAS	Philips GP-400 III	Boron cantilever
6528 B-SAS	Shure M-75 series	Boron cantilever
6530 B-SAS	Shure M-91 series	Boron cantilever
6540 B-SAS	Shure M-92 E	Boron cantilever
6532 B-SAS	Shure M-95 ED	Boron cantilever
6538 B-SAS	Shure M-97 XE	Boron cantilever
6539 B-SAS	Shure M-110E	Boron cantilever
6527 B-SAS	Shure V-15 II, VN-15 MR	Boron cantilever
6524 B-SAS	Shure V-15 III-MR, VN-35 MR	Boron cantilever
6525 B-SAS	Shure V-15 IV-MR, VN-45 MR	Boron cantilever
6529 B-SAS	Shure V-15 V-MR, VN-5 MR	Boron cantilever
6536 B-SAS	Shure V-15 V-x MR, VN-5 MR	Boron cantilever



6411 S-SAS	Elac D-793SH	Sapphire cantilever
6429 S-SAS	National/Technics EPS-30 ES	Sapphire cantilever
6438 S-SAS	National/Technics EPS-202 ED	Sapphire cantilever
6432 S-SAS	National/Technics EPS-205 CEX	Sapphire cantilever
6434 S-SAS	National/Technics EPS-205 CIIS	Sapphire cantilever
6427 S-SAS	National/Technics EPS-270 ED	Sapphire cantilever
6424 S-SAS	Shure M-75 series	Sapphire cantilever
6426 S-SAS	Shure M-91 series	Sapphire cantilever
6477 S-SAS	Shure M-92 E	Sapphire cantilever
6428 S-SAS	Shure M-95 ED	Sapphire cantilever
6441 S-SAS	Shure M-97 XE	Sapphire cantilever
6454 S-SAS	Shure M-110E	Sapphire cantilever
6416 S-SAS	Shure V-15 II, VN-15 MR	Sapphire cantilever
6407 S-SAS	Shure V-15 III-MR, VN-35 MR	Sapphire cantilever
6409 S-SAS	Shure V-15 IV-MR, VN-45 MR	Sapphire cantilever
6425 S-SAS	Shure V-15 V-MR, VN-5 MR	Sapphire cantilever
6435 S-SAS	Shure V-15 V-x MR, VN-5 MR	Sapphire cantilever



6520 R-SAS	National EPS-205EX	Ruby cantilever
6522 R-SAS	Shure M-97 XE	Ruby cantilever
6517 R-SAS	Shure V-15 III-MR, VN-35 MR	Ruby cantilever
6518 R-SAS	Shure V-15 IV-MR, VN-45 MR	Ruby cantilever
6519 R-SAS	Shure V-15 V-MR, VN-5 MR	Ruby cantilever
6521 R-SAS	Shure V-15 V-x MR, VN-5 MR	Ruby cantilever

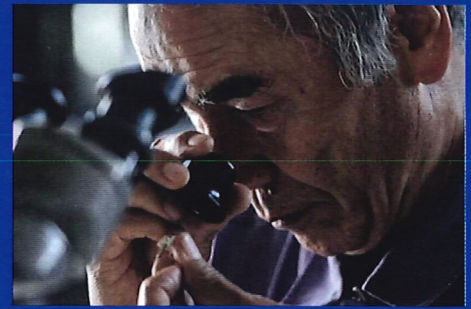

SETO-HORI

瀬戸彫

A Hand-Crafted MC Cartridge with a Ceramic Body featuring a Micro Ridge Diamond Tip and a Boron Cantilever

JICO now launches the "SETO-HORI" Moving Coil (MC) type cartridge. The SETO-HORI MC cartridge is made in the heart of the city of Seto, Japan. This city is famous for its pottery and ceramics. So much, that the generic word for ceramics in Japanese is "Setomono".

For two years, the stylus experts of JICO cooperated with a laboratory in Seto to create the ceramic cabinet. The *Setomono* ceramic cabinet suppresses excess vibration of the high output voltage MC cartridge. The SETO-HORI cartridge uses a special "micro ridge diamond tip", which has a polyhedral shape. Being a line-contact stylus, its life time is at least three times longer compared to ordinary conical or elliptical shaped styli. The cantilever is made of Boron which has a low mass and great stiffness. These characteristics allow the tip to trace the groove more accurately and reproduce low, mid-range and high-frequencies with true fidelity.

The unique pattern of the SETO-HORI cartridge resembles fishing nets of the fishermen in Japan. It follows the philosophy of capturing happiness by capturing beautiful sounds. The detailed pattern imitating the fishing nets is not painted with a brush, but drawn by the mould with a technique called "Hori-Tsuke".

The cartridge body is mounted on a base made of natural walnut tree wood and is processed near Hamamatsu, the city famous for its world-class musical instrument factories. Combining traditional Japanese ceramic and natural wood gives an additional charm to the sound. The SETO-HORI MC cartridge is purely hand-made in Japan.



Specifications:
 Output voltage: 2mV
 Output balance: <1.5dB/1kHz
 Stylus force: 2.0 g
 Channel separation: 25dB/1kHz
 Frequency response: 15-32,000Hz
 Output impedance: 130Ω/1kHz
 Cantilever: Boron
 Stylus shape: Micro Ridge
 Product net weight: 11 g
 Shielding case: Ceramic ware from Seto and walnut tree wood.

All cartridges are shipped with 100% shipping inspection and sound check.

Tonar no. 9636 - SETO HORI MC Cartridge

JICO®

NIPPON PRECISION JEWEL INDUSTRY CO., LTD.

The journey of JICO began in 1873, when its original founder Ichihara Soubei learned manufacturing techniques from Europeans in Nagasaki (Japan). He used these skills to start his own small factory for crafting sewing needles for Kimonos in the remote village of Hamasaka, three hours away from Osaka in the Japanese countryside. The craftsmanship of the sewing needles was so well received, that soon they became known as *Misuya* needles, named for the Kimono they used to make. Due to the remote location of the factories in Hamasaka, the company developed a strong self-reliance on all aspects of the production process and this has contributed to its technological strenght.

As time moved on, the focus of JICO continued with the manufacturing of phonograph needles. In 1959, JICO started with the production of steel needles for phonographs. However, in 1964, JICO's technical expertise and meticulous craftsmanship was blended with the manufacturing of diamond-tipped styli.

At the heart of JICO's high standard are the skilled *Takumi* (Japanese artisans) who hand assemble and check all JICO styli. Stringent quality inspections and tests using unique and high level technology are performed on all materials and at every level — from the manufacture of parts that transmit vibrations to the cartridge (the cantilever, magnet and wire) to the final assembly. Combining unique precision technology with great dedication, has turned JICO styli to become today's quality benchmark. Building on a long history and an ear for quality, JICO is committed to preserving the vinyl record culture and sound for many generations to come.

JICO is exclusively represented by Tonar International for distribution in Europe, Africa and the Middle-East. Both companies share a long history of fruitful cooperation. Established in 1954, Tonar has become the specialist for analog audio, phonograph styli, cartridges and accessories for your turntable and vinyl collection.



tonar
www.tonar.eu

Your JICO dealer:

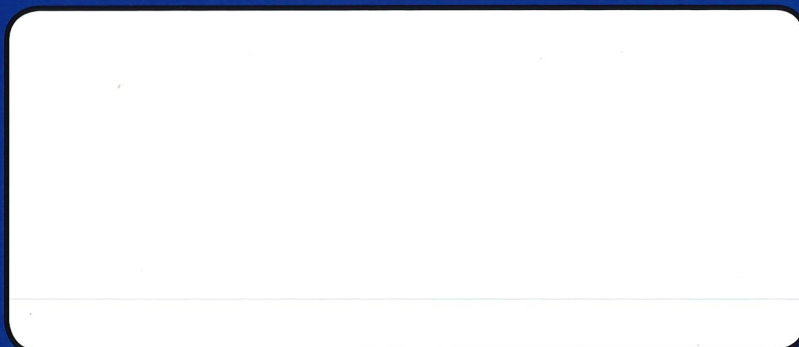

TONAR International B.V. - Beeldschermweg 5 unit 1 - 3821 AH Amersfoort - The Netherlands
Phone: +31 33 - 455 45 11 - Fax: +31 33 - 456 05 44 - E-mail: info@tonar.eu - www.tonar.eu

made with
high precision in Tokyo

ONEARM ACCESSORIES

JAC 501/502

tonearm connector cables



Five-pin plug with
straight DIN connector.

● Tonar article no. 4492

Five-pin plug with
90 degrees DIN connector.

● Tonar article no. 4493

Specifications:

Conductor: OFC
Outer jacket: Flexible PVC
DIN Connector: Phosphor bronze, Brass and others
RCA Connector: Phosphor bronze, Brass and others

JAC 506

XLR balanced tonearm connector cables



Straight 5 pin DIN to 2 XLR
plugs – sep earth.

● Tonar article no. 5385

90 degrees 5 pin DIN to 2
XLR plugs – sep earth.

● Tonar article no. 5908

Specifications:

Conductor: OFC
Outer jacket: Flexible PVC
DIN Connector: Phosphor bronze, Brass and others
XLR Connector: Copper (PCOCC), Aluminum and others

JAC 101/102

economy tonearm connector cables (gold plated)

Five-pin plug with
straight DIN connector.

● Tonar article no. 5454

Five-pin plug with
90 degrees DIN connector.

● Tonar article no. 5456



JL-45

hydraulic tonearm lifter

● Tonar article no. 4498



DO-01

spare oil for oil damped
tonearms

● Tonar article no. 5981



JELCO

ONEARMS AND ACCESSORIES FOR TURNTABLES



made with high precision in Tokyo

TK-950

TK-950L

12" Dynamic-balance / Static-balance compatible with Knife Edge S-type tonearm

- Tonar article no. 5531



TK-950S

9" Dynamic-balance / Static-balance compatible with Knife Edge S-type tonearm

- Tonar article no. 5530



Features:

- The TK-950 tonearms have a unique two-way balance system, allowing for Dynamic-balance or Static-balance.
- The bearing for vertical direction is equipped with an innovative KNIFE EDGE system.
- The Knife Edge material is made from super steel, and has a very stable and smooth operation.
- The Knife Edge system is hand-made, using precision technology for very low friction.
- The high-mass design and the selected materials suppress unwanted vibrations and enhance the sound quality.
- The tonearm's geometry allows for a Baerwald protractor alignment.
- The universal type counterweight can be used for cartridge/headshell combinations with a weight from 17 to 35 grs.
- The tonearms are fitted with a detachable headshell.
- The included magnesium alloy headshell features cartridge azimuth adjustment.
- Digital stylus pressure gauge (SG-1) included.

Model	TK-950L	TK-950S
Bearing System	Knife Edge	
Effective length (from the tonearm pivot to stylus point)	303 mm	232 mm
Distance of the tonearm pivot to spindle	290 mm	214 mm
Overhang (spindle to stylus point)	13 mm	18 mm
Offset angle	17.7°	23.75°
Tracking error angle	+1.45°—0.85°	+1.96°—1.03°
Horizontal sensitivity (first action, inner wire free)	30 mg	30 mg
Vertical sensitivity (first action, inner wire free)	30 mg	30 mg
Suitable cartridge weight with headshell	17~35 gr	17~35 gr
Effective Mass	13.0 gr	13.4 gr
Range of height adjustment (distance between the arm base bottom and centre of the arm pipe)	38~60 mm	38~60 mm

TK-850

TK-850L

12" Static-balance with Knife Edge S-type tonearm

- Tonar article no. 5529



TK-850S

9" Static-balance with Knife Edge S-type tonearm

- Tonar article no. 5528



Features:

- The TK-850 tonearms use a Static-balance system.
- The bearing for vertical direction is equipped with an innovative KNIFE EDGE system.
- The Knife Edge material is made from super steel, and has a very stable and smooth operation.
- The Knife Edge system is hand-made, using precision technology for very low friction.
- The high-mass design and the selected materials suppress unwanted vibrations and enhance the sound quality.
- The tonearm's geometry allows for a Baerwald protractor alignment.
- The universal type counterweight can be used for cartridge/headshell combinations with a weight from 17 to 35 grs.
- The tonearms are fitted with a detachable headshell.
- The included magnesium alloy headshell features cartridge azimuth adjustment.

Model	TK-850L	TK-850S
Bearing System	Knife Edge	
Effective length (from the tonearm pivot to stylus point)	303 mm	232 mm
Distance of the tonearm pivot to spindle	290 mm	214 mm
Overhang (spindle to stylus point)	13 mm	18 mm
Offset angle	17.7°	23.75°
Tracking error angle	+1.45°—0.85°	+1.96°—1.03°
Horizontal sensitivity (first action, inner wire free)	30 mg	30 mg
Vertical sensitivity (first action, inner wire free)	30 mg	30 mg
Suitable cartridge weight with headshell	17~35 gr	17~35 gr
Effective Mass	13.0 gr	13.4 gr
Range of height adjustment (distance between the arm base bottom and centre of the arm pipe)	38~60 mm	38~60 mm

JELCO

Jelco (Ichikawa Jewel Co., LTD) was started in 1920 by Y. Ichikawa. Originally set up to manufacture jewel bearings for watches and measuring equipment, in 1958 the company branched out to creating diamond tipped styli for use in the Hi-Fi industry.

Jelco is now one of the few remaining tonearm manufacturers left in Japan and continues to utilise its 'Zero Friction Technology' for stunning musical reproduction.



Your Jelco dealer:

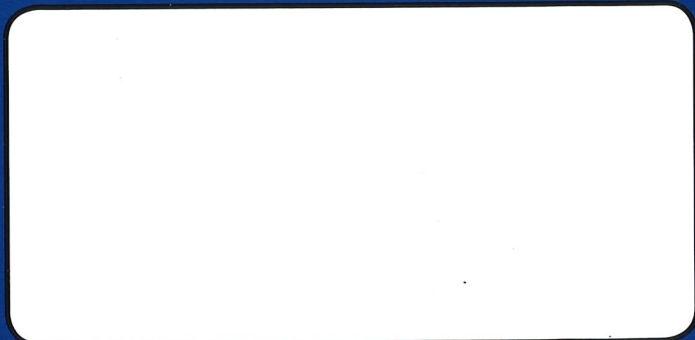

Jelco is exclusively represented in the Benelux by:

TONAR International B.V.

Beeldschemweg 5 unit 1 - 3821 AH Amersfoort - The Netherlands

Phone: +31 33 - 455 45 11 - Fax: +31 33 - 456 05 44

E-mail: info@tonar.eu - www.tonar.eu

JELCO

HEADSHELLS

TopQ High End Headshells

Most turntables are supplied with a standard entry level headshell. The sound quality can be strongly improved by using a so-called "high end shell". The TopQ High End headshells come in two versions, one with a removable arm lifter and one with a fixed arm lifter. Both models have the possibility to adjust the pitch of the shell axial wise, as compared to the tonearm. This allows an exact vertical mounting of the cartridge and stylus tip onto the record. The finest quality OFC (Oxygen Free Copper) lead wires are used in the TopQ headshells. Both models are available in black or in silver/bronze. All TopQ models have a SME type connector for use on S-type tonearms.

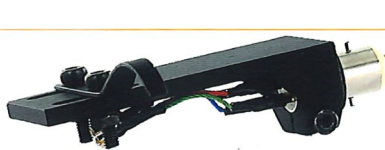

TopQ headshell (black)
with removable arm lifter
• Tonar article no. 4420



TopQ headshell (black)
with fixed arm lifter
• Tonar article no. 5330



TopQ headshell (silver/bronze)
with removable arm lifter
• Tonar article no. 5907



TopQ headshell (silver/bronze)
with fixed arm lifter
• Tonar article no. 5386

Specifications:

- Magnesium Alloy body
- Azimuth adjustable
- Universal mount
- Two lock pin
- Silk weaved OFC litz lead wires with gold plated terminal
- PIN conductor: Gold plated
- Weight: 12.1 grams without screws

Rosewood High End Headshell

This state-of-the-art headshell made of Rosewood, is a high quality audiophile headshell and provides an elegant solution with a variety of cartridges. It has a SME style locking collar (as found on most tone arms with removable headshells). The connectors are gold plated and the included headshell leads are silver plated.



Specifications:

- Magnesium Alloy body with rosewood
- Azimuth adjustable
- Universal mount
- Gold plated copper arm lifter
- Two lock pin
- 4N all pure silver lead wires with gold plated terminal
- PIN conductor: Gold plated
- Weight: 16.9 grams without screws

• Tonar article no. 5327

TS-550

TS-550L

12" Static-balance oil damping S-type tonearm

- Tonar article no. 5532

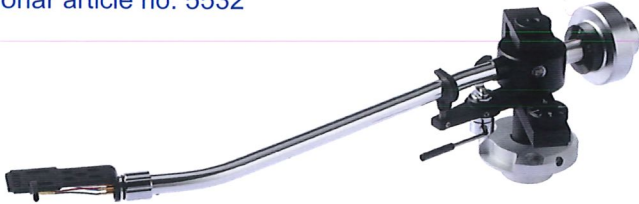

TS-550S

9" Static-balance oil damping S-type tonearm

- Tonar article no. 5535



Features:

- The TS-550 tonearms incorporate an oil damping system. This improves bass performance, and protects vinyl records from damage caused by jumping of the stylus during playback.
- The bearing for vertical direction is equipped with a one point cross suspension system with low friction.
- The mechanism enhances the sound quality.
- The tonearm's geometry allows for a Baerwald protractor alignment.
- The universal type counterweight can be used for cartridge/headshell combinations with a weight from 17 to 34 grs.
- The tonearms are fitted with a standard detachable headshell.

Model	TS-550L	TS-550S
Bearing System	One point cross suspension	
Effective length (from the tonearm pivot to stylus point)	303 mm	232 mm
Distance of the tonearm pivot to spindle	290 mm	214 mm
Overhang (spindle to stylus point)	13 mm	18 mm
Offset angle	17.7°	23.75°
Tracking error angle	+1.45°—0.85°	+1.96°—1.03°
Horizontal sensitivity (first action, inner wire free)	30 mg	30 mg
Vertical sensitivity (first action, inner wire free)	30 mg	30 mg
Suitable cartridge weight with headshell	17~34 gr	17~34 gr
Effective Mass	9.0 gr	9.2 gr
Range of height adjustment (distance between the arm base bottom and centre of the arm pipe)	38~60 mm	38~60 mm
Additional function	Oil damping	

TS-350

TS-350L

12" Static-balance S-type tonearm

- Tonar article no. 5536



TS-350S

9" Static-balance S-type tonearm

- Tonar article no. 5537



Features:

- The TS-350 tonearms use Jelco's stable basic mechanism.
- The bearing for vertical direction is equipped with a one point cross suspension system with low friction.
- The mechanism enhances the sound quality.
- The tonearm's geometry allows for a Baerwald protractor alignment.
- The universal type counterweight can be used for cartridge/headshell with a weight from 17 to 34 grs.
- The tonearms are fitted with a standard detachable headshell.

Model	TS-350L	TS-350S
Bearing System	One point cross suspension	
Effective length (from the tonearm pivot to stylus point)	303 mm	232 mm
Distance of the tonearm pivot to spindle	290 mm	214 mm
Overhang (spindle to stylus point)	13 mm	18 mm
Offset angle	17.7°	23.75°
Tracking error angle	+1.45°—0.85°	+1.96°—1.03°
Horizontal sensitivity (first action, inner wire free)	30 mg	30 mg
Vertical sensitivity (first action, inner wire free)	30 mg	30 mg
Suitable cartridge weight with headshell	17~34 gr	17~34 gr
Effective Mass	9.0 gr	9.2 gr
Range of height adjustment (distance between the arm base bottom and centre of the arm pipe)	38~60 mm	38~60 mm