



# HS Series

POWERED STUDIO MONITOR

# HS8 / HS7 / HS5

POWERED SUBWOOFER

# HS8S



Owner's Manual  
Bedienungsanleitung  
Mode d'emploi  
Manual de instrucciones  
Manual do Proprietário  
Manuale di istruzioni  
Руководство пользователя

使用说明书

取扱説明書

POWERED SPEAKER SYSTEM

English

Deutsch

Français

Español

Português

Italiano

Русский

中文

EN

DE

FR

ES

PT

IT

RU

ZH

JA

日本語

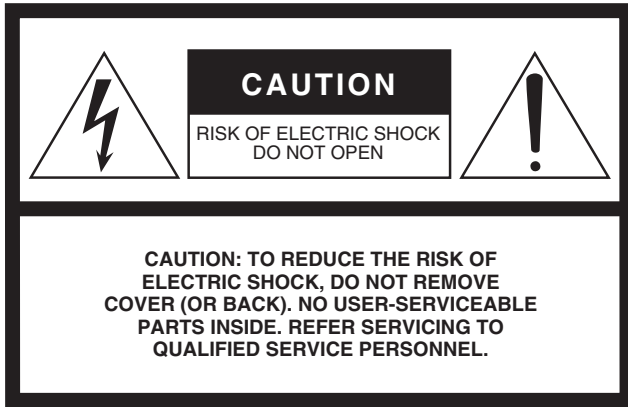

The above warning is located on the rear of the unit.

## Explanation of Graphical Symbols

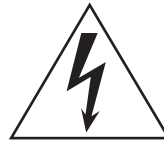

The lightning flash with arrowhead symbol within an equilateral triangle is intended to alert the user to the presence of uninsulated “dangerous voltage” within the product’s enclosure that may be of sufficient magnitude to constitute a risk of electric shock to persons.



The exclamation point within an equilateral triangle is intended to alert the user to the presence of important operating and maintenance (servicing) instructions in the literature accompanying the product.

# IMPORTANT SAFETY INSTRUCTIONS

- 1 Read these instructions.
- 2 Keep these instructions.
- 3 Heed all warnings.
- 4 Follow all instructions.
- 5 Do not use this apparatus near water.
- 6 Clean only with dry cloth.
- 7 Do not block any ventilation openings. Install in accordance with the manufacturer’s instructions.
- 8 Do not install near any heat sources such as radiators, heat registers, stoves, or other apparatus (including amplifiers) that produce heat.
- 9 Do not defeat the safety purpose of the polarized or grounding-type plug. A polarized plug has two blades with one wider than the other. A grounding type plug has two blades and a third grounding prong. The wide blade or the third prong are provided for your safety. If the provided plug does not fit into your outlet, consult an electrician for replacement of the obsolete outlet.
- 10 Protect the power cord from being walked on or pinched particularly at plugs, convenience receptacles, and the point where they exit from the apparatus.
- 11 Only use attachments/accessories specified by the manufacturer.
- 12 Use only with the cart, stand, tripod, bracket, or table specified by the manufacturer, or sold with the apparatus. When a cart is used, use caution when moving the cart/apparatus combination to avoid injury from tip-over.
- 13 Unplug this apparatus during lightning storms or when unused for long periods of time.
- 14 Refer all servicing to qualified service personnel. Servicing is required when the apparatus has been damaged in any way, such as power-supply cord or plug is damaged, liquid has been spilled or objects have fallen into the apparatus, the apparatus has been exposed to rain or moisture, does not operate normally, or has been dropped.



### WARNING

TO REDUCE THE RISK OF FIRE OR ELECTRIC SHOCK, DO NOT EXPOSE THIS APPARATUS TO RAIN OR MOISTURE.

(UL60065\_03)

### IMPORTANT NOTICE FOR THE UNITED KINGDOM

#### Connecting the Plug and Cord

**WARNING:** THIS APPARATUS MUST BE EARTHED IMPORTANT. The wires in this mains lead are coloured in accordance with the following code:

GREEN-AND-YELLOW	:	EARTH
BLUE	:	NEUTRAL
BROWN	:	LIVE

As the colours of the wires in the mains lead of this apparatus may not correspond with the coloured markings identifying the terminals in your plug proceed as follows:

The wire which is coloured GREEN-and-YELLOW must be connected to the terminal in the plug which is marked by the letter E or by the safety earth symbol  or colored GREEN or GREEN-and-YELLOW.

The wire which is coloured BLUE must be connected to the terminal which is marked with the letter N or coloured BLACK.

The wire which is coloured BROWN must be connected to the terminal which is marked with the letter L or coloured RED.

이 기기는 가정용(B급) 전자파적합기기로서 주로 가정에서 사용하는 것을 목적으로 하며, 모든 지역에서 사용할 수 있습니다.

(class b korea)

# Contents

<b>Features</b> .....	<b>3</b>
<b>Included Items (please check)</b> .....	<b>3</b>
<b>PRECAUTIONS</b> .....	<b>4</b>
<b>NOTICE</b> .....	<b>6</b>
<b>Information</b> .....	<b>6</b>
<b>Rear Panel</b> .....	<b>7</b>
<b>Setup</b> .....	<b>9</b>
<b>Troubleshooting</b> .....	<b>13</b>
<b>Connection and Cable Types</b> .....	<b>14</b>
<b>Specifications</b> .....	<b>118</b>
<b>Dimensions</b> .....	<b>118</b>
<b>Performance Graph</b> .....	<b>119</b>
<b>Block Diagram</b> .....	<b>119</b>

Thank you for choosing a Yamaha powered monitor speaker or powered subwoofer. In order to take maximum advantage of the speaker's features and ensure maximum performance and longevity, please read this manual carefully before using powered monitor speaker or powered subwoofer. Keep the manual in a safe place for future reference.

# Features

The new HS series powered monitors inherit the underlying philosophy that has made Yamaha monitors standards in studios around the world, delivering accurate, detailed reproduction that is essential for quality sound production.

- Accurate, detailed reproduction of the source.
- A choice of three full-range models plus one high-performance subwoofer makes it easy to create systems that are ideally matched to any monitoring environment.
- Simple 2-way design in the full-range models, with optimally matched high and low frequency units.
- Response-tailoring controls match speaker output to a wide range of acoustic spaces.
- In addition to studio standard XLR connectors, phone jacks allow direct connection of electronic musical instruments and other sources.

# Included Items (please check)

- **Power cord**
- **Owner's Manual (this book)**

# PRECAUTIONS

## PLEASE READ CAREFULLY BEFORE PROCEEDING

\* Please keep this manual in a safe place for future reference.



## WARNING

Always follow the basic precautions listed below to avoid the possibility of serious injury or even death from electrical shock, short-circuiting, damages, fire or other hazards. These precautions include, but are not limited to, the following:

### Power supply/Power cord

- Do not place the power cord near heat sources such as heaters or radiators, and do not excessively bend or otherwise damage the cord, place heavy objects on it, or place it in a position where anyone could walk on, trip over, or roll anything over it.
- Only use the voltage specified as correct for the device. The required voltage is printed on the name plate of the device.
- Use only the supplied power cord/plug.
- Check the electric plug periodically and remove any dirt or dust which may have accumulated on it.
- Be sure to connect to an appropriate outlet with a protective grounding connection. Improper grounding can result in electrical shock.

### Do not open

- This device contains no user-serviceable parts. Do not open the device or attempt to disassemble the internal parts or modify them in any way. If it should appear to be malfunctioning, discontinue use immediately and have it inspected by qualified Yamaha service personnel.

### Water warning

- Do not expose the device to rain, use it near water or in damp or wet conditions, or place on it any containers (such as vases, bottles or glasses) containing liquids which might spill into any openings. If any liquid such as water seeps into the device, turn off the power immediately and unplug the power cord from the AC outlet. Then have the device inspected by qualified Yamaha service personnel.
- Never insert or remove an electric plug with wet hands.

### Fire warning

- Do not put burning items, such as candles, on the unit. A burning item may fall over and cause a fire.

### If you notice any abnormality

- When one of the following problems occur, immediately turn off the power switch and disconnect the electric plug from the outlet. Then have the device inspected by Yamaha service personnel.
  - The power cord or plug becomes frayed or damaged.
  - It emits unusual smells or smoke.
  - Some object has been dropped into the instrument.
  - There is a sudden loss of sound during use of the device.
- If this device should be dropped or damaged, immediately turn off the power switch, disconnect the electric plug from the outlet, and have the device inspected by qualified Yamaha service personnel.

## CAUTION

Always follow the basic precautions listed below to avoid the possibility of physical injury to you or others, or damage to the device or other property. These precautions include, but are not limited to, the following:

### Power supply/Power cord

- When removing the electric plug from the device or an outlet, always hold the plug itself and not the cord. Pulling by the cord can damage it.
- Remove the electric plug from the outlet when the device is not to be used for extended periods of time, or during electrical storms.

### Location

- Do not place the device in an unstable position where it might accidentally fall over.
- Do not use the device in a confined, poorly-ventilated location. Make sure that there is adequate space between the device and surrounding walls or other devices: at least 20 cm at the sides, 20 cm behind and 20 cm above. Inadequate ventilation can result in overheating, possibly causing damage to the device(s), or even fire.
- Do not press the rear panel of the device against the wall. Doing so may cause the plug to come in contact with the wall and detach from the power cord, resulting in short circuiting, malfunction, or even fire.
- Do not place the device in a location where it may come into contact with corrosive gases or salt air. Doing so may result in malfunction.
- Before moving the device, remove all connected cables.
- When setting up the device, make sure that the AC outlet you are using is easily accessible. If some trouble or malfunction occurs, immediately turn off the power switch and disconnect the plug from the outlet. Even when the power switch is turned off, electricity is still flowing to the product at the minimum level. When you are not using the product for a long time, make sure to unplug the power cord from the wall AC outlet.

### Connections

- Before connecting the device to other devices, turn off the power for all devices. Before turning the power on or off for all devices, set all volume levels to minimum.

### Maintenance

- Remove the power plug from the AC outlet when cleaning the device.

### Handling caution

- Do not insert your fingers or hands in any gaps or openings on the device (ports).
- Avoid inserting or dropping foreign objects (paper, plastic, metal, etc.) into any gaps or openings on the device (ports). If this happens, turn off the power immediately and unplug the power cord from the AC outlet. Then have the device inspected by qualified Yamaha service personnel.
- Do not rest your weight on the device or place heavy objects on it, and avoid use excessive force on the buttons, switches or connectors.
- Do not use speakers for a long period of time at a high or uncomfortable volume level, since this can cause permanent hearing loss. If you experience any hearing loss or ringing in the ears, consult a physician.
- Do not operate the device if the sound is distorting. Prolonged use in this condition could cause overheating and result in fire.

Yamaha cannot be held responsible for damage caused by improper use or modifications to the device, or data that is lost or destroyed.

Always turn the power off when the device is not in use.

# NOTICE

To avoid the possibility of malfunction/ damage to the product, damage to data, or damage to other property, follow the notices below.

## ■ Handling and Maintenance

- Do not expose the device to excessive dust or vibration, or extreme cold or heat (such as in direct sunlight, near a heater, or in a car during the day), in order to prevent the possibility of panel disfiguration, unstable operation, or damage to the internal components.
- Do not place vinyl, plastic or rubber objects on the device, since this might discolor the panel.
- When cleaning the device, use a dry and soft cloth. Do not use paint thinners, solvents, cleaning fluids, or chemical-impregnated wiping cloths.
- Condensation can occur in the device due to rapid, drastic changes in ambient temperature—when the device is moved from one location to another, or air conditioning is turned on or off, for example. Using the device while condensation is present can cause damage. If there is reason to believe that condensation might have occurred, leave the device for several hours without turning on the power until the condensation has completely dried out.
- During extreme changes in temperature or humidity, condensation may occur and water may collect on the surface of the device. If water is left, the wooden parts may absorb the water and be damaged. Make sure to wipe any water off immediately with a soft cloth.
- **Interference From Cell Phones**  
Using a cell phone near the speaker system can induce noise. If this occurs, move the cell phone further away from the speaker system.
- Air blowing out of the bass reflex ports is normal, and often occurs when the speaker is handling program material with heavy bass content.
- Always turn the power off when the device is not in use.
- Avoid touching or allowing objects to come in contact with the speaker diaphragms.
- These speakers should be used vertically, not laid on their side.

## ■ Connectors

- XLR-type connectors are wired as follows (IEC60268 standard): pin 1: ground, pin 2: hot (+), and pin 3: cold (-).

# Information

## ■ About this manual

- The illustrations as shown in this manual are for instructional purposes only, and may appear somewhat different from those on your device.
- Steinberg and Cubase are registered trademarks of Steinberg Media Technologies GmbH.
- The company names and product names in this manual are the trademarks or registered trademarks of their respective companies.

# Rear Panel

The HS8/HS7/HS5/HS8S switches and connectors are located on the rear panel, as described below.

## HS8/HS7/HS5

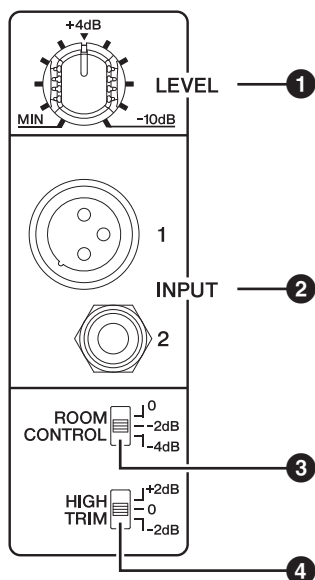

## Speaker Input and Response Control

### 1 LEVEL control

Adjusts the output level of the speaker. When set to the 12-o'clock position the speaker is optimized for a nominal input level of +4 dB.

### 2 INPUT 1/2 connector

These connectors receive the input signal to the speaker. Two input connectors are provided: one balanced XLR connector, and one balanced (TRS) phone jack.

**NOTE** The XLR and phone jack input connectors can not be used simultaneously. Use only one input connector at a time.

**NOTE** Refer to "Connection and Cable Types" on page 14 for more connector details.

### 3 ROOM CONTROL switch

Adjusts the speaker's low-frequency response. This switch can be used to compensate for exaggerated low-frequency response that can be caused by reflections in some listening environments. Setting the switch to the [0] position produces a flat frequency response. The [-2 dB] setting attenuates the range below 500 Hz by 2 dB, and the [-4 dB] setting attenuates the range below 500 Hz by -4 dB.

### 4 HIGH TRIM switch

Adjusts the speaker's high-frequency response. Setting the switch to the [0] position produces a flat frequency response. The [+2 dB] setting boosts the range above 2 kHz by 2 dB, while the [-2 dB] setting attenuates the range above 2 kHz by -2 dB.

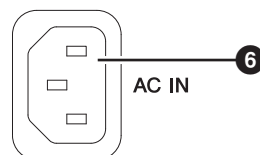

### 5 Power switch

Turns power to the speaker ON or OFF. Rock the switch to the right [ I ] to turn the power ON, or to the left [ ⏻ ] to turn the power OFF. The Yamaha logo on the front panel will light when the power is ON.

**NOTE** Turning the power switch ON and OFF in rapid succession can cause the device's electronics to malfunction. Please wait for 3 seconds or more after turning the power OFF before turning it ON again.

### 6 AC IN connector

Connect the supplied power cable here. First connect the power cord to the speaker, then insert the power cord plug into the AC outlet.

# HS8S (Subwoofer)

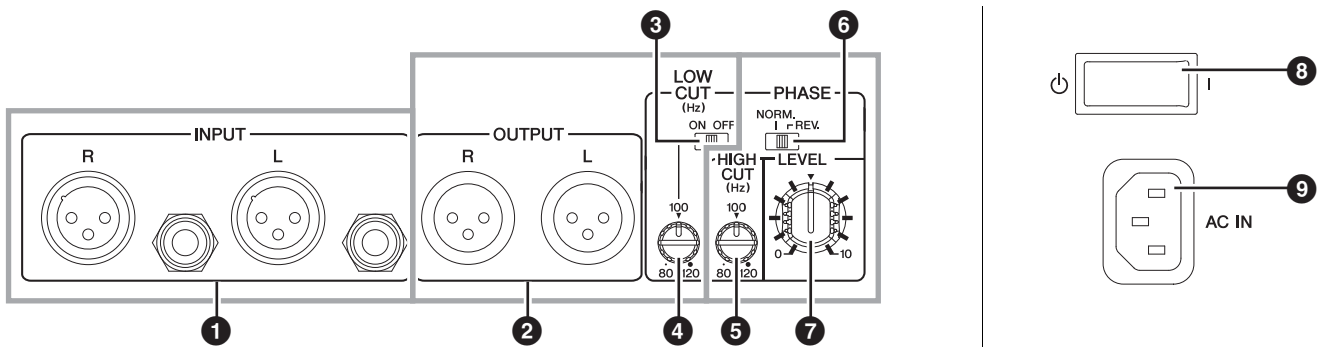

## Subwoofer Connections

### 1 INPUT L/R connector

These connectors receive the input signal to the subwoofer. Balanced XLR and balanced phone jack connectors are provided for both the L and R inputs. The L and R inputs can be used simultaneously. Signals supplied to both the L and R inputs are mixed internally.

**NOTE** The XLR and phone jack input connectors can not be used simultaneously. Use only one input connector at a time.

**NOTE** Refer to "Connection and Cable Types" on page 14 for more connector details.

## HS8S signal flow

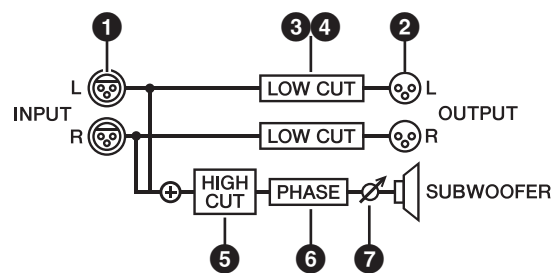

## Connecting the Subwoofer to the HS8/HS7/HS5 Speakers

### 2 OUTPUT L/R connectors

These are the subwoofer's output connectors. The input signals received at the INPUT L and R connectors are output via the OUTPUT L and R connectors, respectively. Low frequency reproduction characteristics can be adjusted via the LOW CUT switch and LOW CUT control.

### 3 LOW CUT switch

When this switch is ON, the low frequencies are attenuated prior to output via the OUTPUT L and R connectors at the frequency set by the LOW CUT control. The low-frequency attenuation cutoff frequency can be adjusted via the LOW CUT control.

### 4 LOW CUT control

Adjusts the low-frequency attenuation cutoff frequency between 80 Hz and 120 Hz when the LOW CUT switch is ON.

## Subwoofer Response Control

### 5 HIGH CUT control

Sets the cutoff frequency for subwoofer output high-frequency attenuation from 80 Hz to 120 Hz.

### 6 PHASE switch

Switches the phase of the subwoofer output. This switch should be set to [NORM.] in most situations, but in combination with some speakers and in some speaker layouts switching to the [REV.] setting may improve low-frequency response. Select the setting that provides the best bass response in your system.

### 7 LEVEL control

Adjusts the subwoofer output level.

### 8 Power switch

Turns power to the subwoofer ON or OFF. Rock the switch to the right [ I ] to turn the power ON, or to the left [ ⏻ ] to turn the power OFF. The Yamaha logo on the front panel will light when the power is ON.

**NOTE** Turning the power switch ON and OFF in rapid succession can cause the device's electronics to malfunction. Please wait for 3 seconds or more after turning the power OFF before turning it ON again.

### 9 AC IN connector

Connect the supplied power cable here. First connect the power cord to the subwoofer, then insert the power cord plug into the AC outlet.



# Setup

In this section we'll look at the general procedure for connecting and setting up a monitor speaker system. This is just an example though, so feel free to set up your own system in the way that best serves your personal listening needs.

## Cables

You'll need to acquire appropriate cables to connect the HS series monitor speakers to your audio interface or other source equipment.

- **Short, high-quality cables**

Use high-quality cables of the shortest practical length. The longer the cable, the more chance there is that noise will creep in to degrade your sound.

- **Balanced cables**

Balanced cables are more resistant to noise than unbalanced cables. If you have to use unbalanced cables because the source equipment only has unbalanced outputs, be sure to use the shortest possible unbalanced cables.

### ■ Recommended cables

- For connection to a balanced phone jack input.

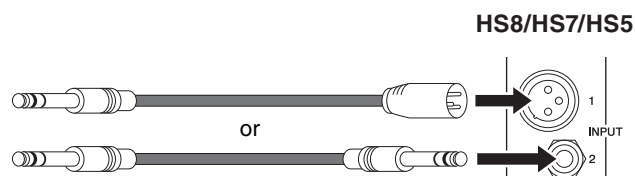

- For connection to an unbalanced phone jack input.

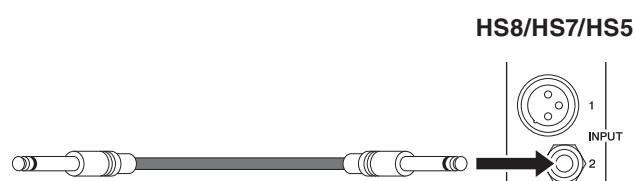

**NOTE** Refer to "Connection and Cable Types" on page 14 for more connector details. The configurations of the balanced and unbalanced phone jack connectors are different.

## Connections

**NOTE** Plug the supplied AC power cord into the corresponding socket on the speaker. Plug the power cord into the speaker first, and then insert the AC plug end into an appropriate AC wall outlet.

### Connecting to an Audio Interface

When connecting an audio interface (Steinberg UR or MR series, etc.) to HS series speakers, connect the audio interface output connectors directly to the speakers' input connectors. Normally you'll connect to the LINE OUT 1 and 2 (1L and 2R outputs), although that might depend on the specific audio interface and DAW (Digital Audio Workstation) settings used.

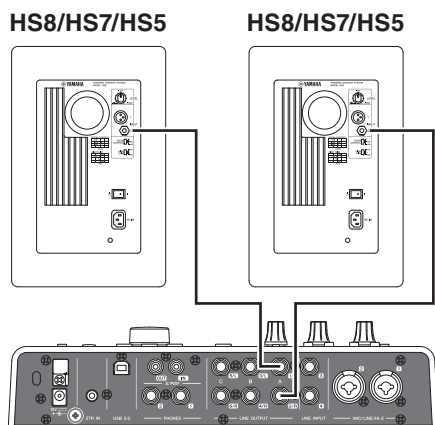

### Connecting to a Mixer

When connecting a mixer (Yamaha MGP or MG series, etc.) to HS series speakers, connect the mixer's MONITOR OUT or C-R OUT (Control Room) connectors directly to the speakers' input connectors. This makes it possible to control the monitor level independently from the mixer's main bus level.

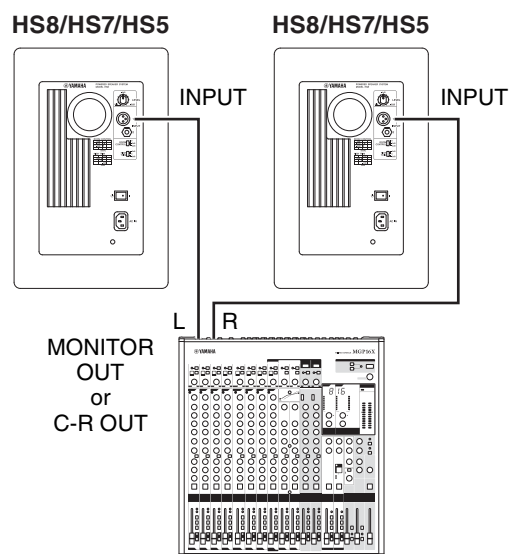

■ **Recommended cables**

- For connection to a balanced XLR input.

HS8/HS7/HS5

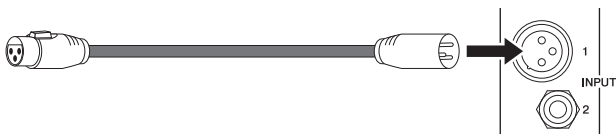

- For connection to an unbalanced phone jack input.

HS8/HS7/HS5

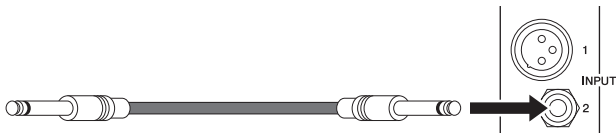

**NOTE** Refer to “Connection and Cable Types” on page 14 for more connector details. The configurations of the balanced and unbalanced phone jack connectors are different.

**Connecting to a Synthesizer or Other Electronic Musical Instrument**

When connecting an electronic musical instrument such as a Yamaha MOTIF synthesizer to the HS series speakers, connect the instrument’s L/MONO and R outputs to the HS speaker inputs.

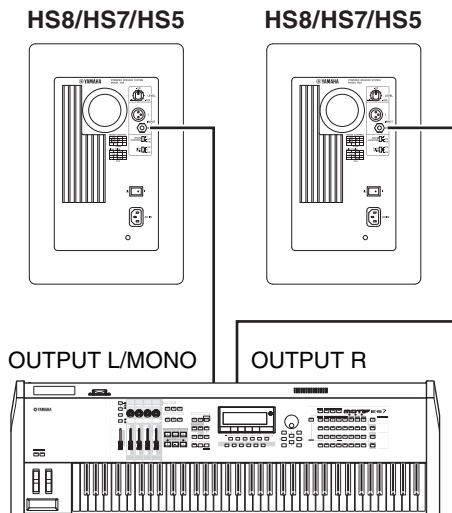

■ **Recommended cables**

- For connection to an unbalanced phone jack input.

HS8/HS7/HS5

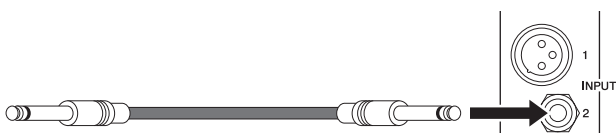

**NOTE** Refer to “Connection and Cable Types” on page 14 for more connector details. The configurations of the balanced and unbalanced phone jack connectors are different.

**Setting Up for Superior Sound**

A number of points should be observed when laying out a monitor speaker system.

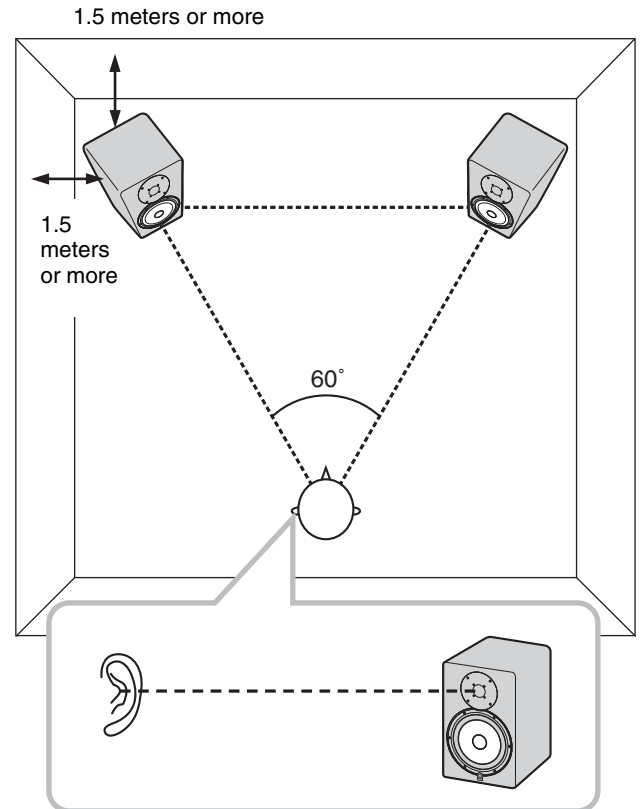

■ **Point 1**

**Position speakers at least 1.5 meters away from walls or corners.**

Ideally, the speakers should be located at least 1.5 meters away from walls or corners. In situations where it is not possible to position the speakers a sufficient distance from walls or corners, the ROOM CONTROL switch can be used compensate for excessive bass. As you move the speaker closer to walls or corners, a higher compensation setting may be required to achieve natural sounding response ([0] → [-2] → [-4]).

## ■ Point 2

### Position the left and right speakers symmetrically.

The left and right speakers should be positioned as symmetrically as possible in relation to the room. In other words, the left and right speakers should be the same distance from the rear wall and the respective left and right walls.

## ■ Point 3

### The optimum listening position is at the apex of an equilateral triangle.

For the most accurate sound and balance, position yourself at the apex of an equilateral triangle formed by the left and right speakers and yourself, with the speakers angled inward so that they're facing you.

## ■ Point 4

### Position the tweeters at ear height.

High frequencies are quite directional, so for the most accurate monitoring the speakers should be set up so that the tweeters are at approximately the same height as your ears when you're seated at the listening position.

## HS8/HS7/HS5 Settings

Once the physical layout of your monitor system is finalized, you can begin making the following settings.

- 1 Turn the level/volume controls on all source equipment (audio interface, etc.) all the way down.
- 2 Set the HS8/HS7/HS5 LEVEL control to the 12-o'clock position, and set both ROOM CONTROL and HIGH TRIM switches to 0 dB.
- 3 Turn the power to connected audio source devices on first, and then turn on power to the speakers.

**NOTE** When turning power off, turn off the speakers first, and then turn off connected audio source devices.

- 4 Play some source material and gradually raise the level/volume controls on the source equipment.

**NOTE** Be careful not to suddenly apply an excessively loud signal to the system. Excessive level can damage the speakers.

- 5 Set the listening level to a level at which you can listen comfortably without fatigue for an extended period of time.

**NOTE** If necessary, adjust the ROOM CONTROL and HIGH TRIM switches for the most natural response (refer to page 7).

## Adding a Subwoofer (HS8S)

Adding a subwoofer to your monitor system can significantly improve its low-frequency fidelity, making it possible to create better overall mixes.

The subwoofer is normally placed on the floor between the left and right full-range speakers, but since the subwoofer reproduces low frequencies below 200 Hz that are relatively non-directional, subwoofer positioning is not critical.

Four cables are required: two to connect the audio interface or other source equipment to the HS8S subwoofer, and two more to connect the subwoofer to the left and right HS8/HS7/HS5 main speakers.

The connections are made as shown below.

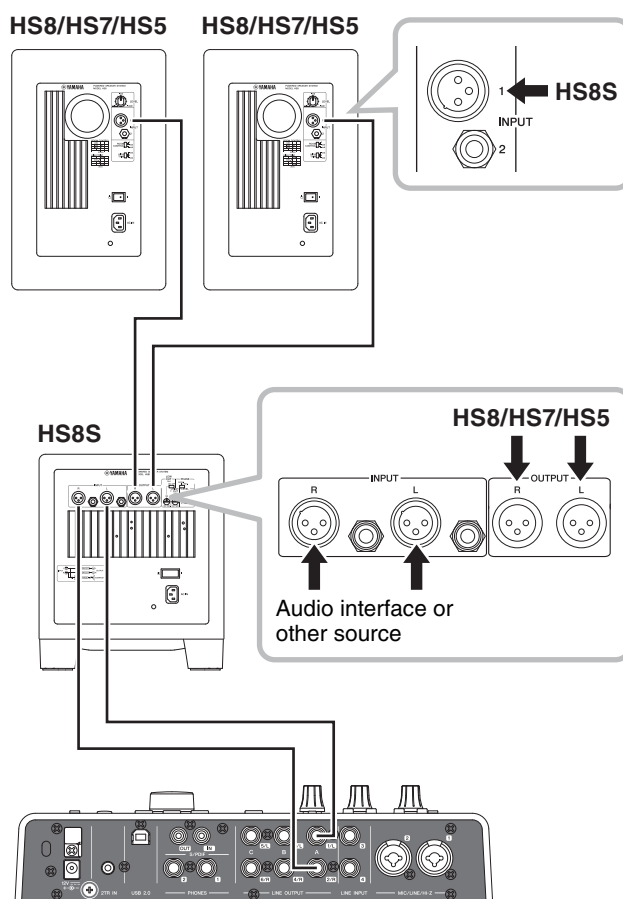

**NOTE** Plug the supplied AC power cord into the corresponding socket on the speaker. Plug the power cord into the speaker first, and then insert the AC plug end into an appropriate AC wall outlet.

## ■ Recommended cables

### Cables for connecting the audio source (audio interface, etc.) to the HS8S

- For connection to a balanced phone jack input.

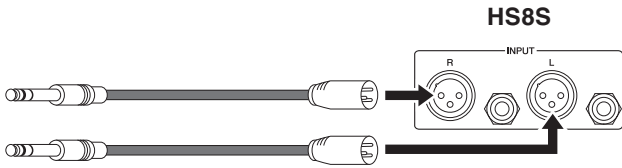

- For connection to a balanced XLR input.

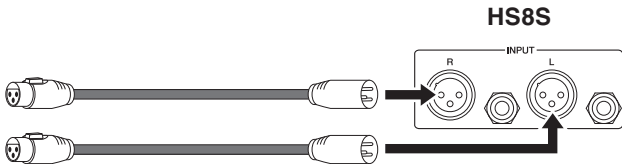

- For connection to an unbalanced phone jack input.

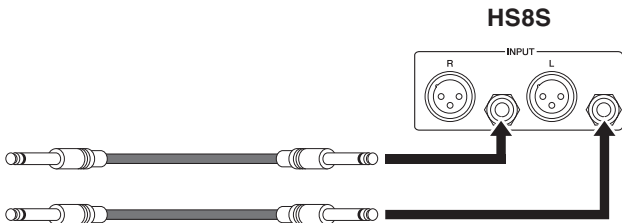

### Cables for connection between the HS8S and HS8/HS7/HS5

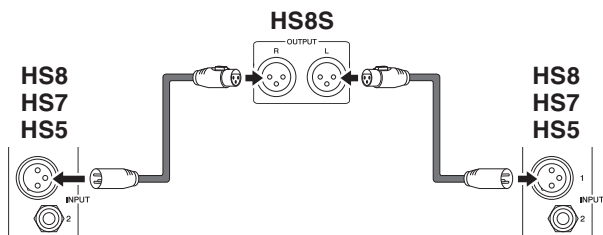

**NOTE** Refer to "Connection and Cable Types" on page 14 for more connector details. The configurations of the balanced and unbalanced phone jack connectors are different.

## ■ Settings for Speakers Plus Subwoofer

Once the subwoofer connections have been made and the layout is finalized, you can begin making the following settings.

- 1 Turn the level/volume controls on all source equipment (audio interface, etc.) all the way down.**

- 2 Set the HS8/HS7/HS5 LEVEL control to the 12-o'clock position, and set both ROOM CONTROL and HIGH TRIM switches to 0 dB.**

- 3 Set the HS8S LEVEL control to 0, the HIGH CUT and LOW CUT controls to their 12-o'clock positions, and set the LOW CUT switch to OFF.**

- 4 Turn power on in the following order: audio source devices, then subwoofer, and finally the full-range speakers.**

**NOTE** Turn power off in the following order: full-range speakers, then subwoofer, and finally audio source devices.

- 5 Play some source material and gradually raise the level/volume controls on the source equipment.**

**NOTE** Be careful not to suddenly apply an excessively loud signal to the system. Excessive level can damage the speakers.

- 6 Set the HS8S LEVEL control to between 10 and 12 o'clock, and turn the LOW CUT switch ON.**

- 7 Set the listening level to a level at which you can listen comfortably without fatigue for an extended period of time.**

**NOTE** If necessary, adjust the ROOM CONTROL and HIGH TRIM switches for the most natural response (refer to page 7).

**NOTE** If necessary, adjust the LOW CUT and HIGH CUT controls and the PHASE switch for the most natural response (refer to page 8).

# Troubleshooting

Symptom	Possible Cause	Solution
Power won't turn on / front panel logo doesn't light.	The power cord might not be connected properly.	Check and connect the power cord.
	The power switch might not be turned on.	Turn the power switch ON. If the problem persists, contact your Yamaha dealer.
No sound.	One or more cables might not be connected properly.	Check that all cables are properly connected.
	The source equipment might not be supplying an audio signal.	Make sure that the source equipment is functioning properly and delivering the required signal.
	The level setting might be too low.	Adjust the output level setting of the source equipment, or use the LEVEL control to increase the output level.
	Are cables connected to both the XLR and phone jack INPUT connectors?	The XLR and phone jack input connectors can not be used simultaneously. Use only one input connector at a time.
Noisy or distorted sound.	One or more cables might be corroded, shorted, or otherwise broken.	Replace faulty cable(s).
	The system might be picking up external noise.	Try changing the positions or layout of the cables.
		Try changing the location of other electrical/ electronic devices that are near the speakers.

# Connection and Cable Types

To allow direct connection to equipment in a wide variety of working environments, the HS speakers are equipped with one XLR and one phone connector that both support balanced as well as unbalanced connections.

## Balanced or Unbalanced

Balanced connections provide greater resistance to noise that can be picked up from external sources, effectively canceling induced noise while leaving the desired audio signal intact. Since the chance that noise will be picked up increases with the length of the cable, balanced connections are preferred for long cable runs. Unbalanced cables are commonly used to connect electronic musical instruments and guitars, etc., to amplification equipment. If your cable runs won't be any longer than around one or two meters, which should suffice in most small rooms, then unbalanced cables can probably be used without any problems. If the source device has balanced outputs, the use of balanced cables is recommended to ensure optimum signal quality.

## Cables

The following types of cable connectors can be used with HS series speakers.

### XLR Connectors

XLR type connectors are widely used in professional audio equipment and installations. The three-pin XLR type connectors provided on the HS series speakers are primarily intended for use with balanced connections. XLR type plugs are rugged and reliable, and are therefore a good choice for outdoor applications.

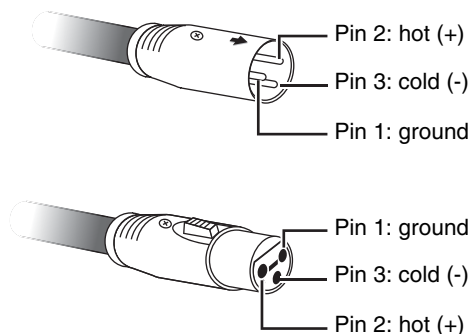

### Phone Connectors

Phone type connectors can be used for both unbalanced and balanced connections. Cables fitted with TRS (Tip, Ring, Sleeve) phone plugs must be used to make balanced connections to the HS series speakers. The construction of TRS phone plugs is basically the same as stereo phone plugs.

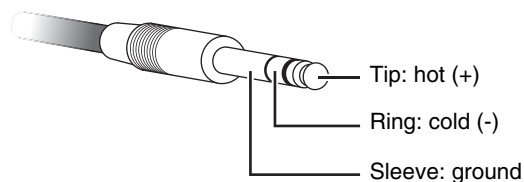

Connect standard mono phone plug cables to the HS speaker phone connectors for unbalanced connections.

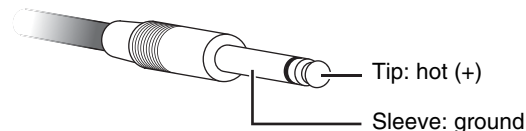

### RCA Pin Connectors

Source devices that only have RCA pin type output connectors can be connected via RCA pin plug to phone plug conversion cables (cables with an RCA pin plug on one end and a phone plug on the other). Connections using RCA pin plug to phone plug conversion cables are unbalanced.

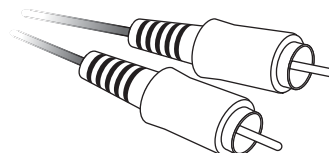

\* Specifications and descriptions in this owner's manual are for information purposes only. Yamaha Corp. reserves the right to change or modify products or specifications at any time without prior notice. Since specifications, equipment or options may not be the same in every locale, please check with your Yamaha dealer.

\* Die technischen Daten und Beschreibungen in dieser Bedienungsanleitung dienen nur der Information. Yamaha Corp. behält sich das Recht vor, Produkte oder deren technische Daten jederzeit ohne vorherige Ankündigung zu verändern oder zu modifizieren. Da die technischen Daten, das Gerät selbst oder Sonderzubehör nicht in jedem Land gleich sind, setzen Sie sich im Zweifel bitte mit Ihrem Yamaha-Händler in Verbindung.

\* Les caractéristiques techniques et les descriptions du mode d'emploi ne sont données que pour information. Yamaha Corp. se réserve le droit de changer ou modifier les produits et leurs caractéristiques techniques à tout moment sans aucun avis. Du fait que les caractéristiques techniques, les équipements et les options peuvent différer d'un pays à l'autre, adressez-vous au distributeur Yamaha le plus proche.

\* Las especificaciones y descripciones de este manual del propietario tienen sólo el propósito de servir como información. Yamaha Corp. se reserva el derecho a efectuar cambios o modificaciones en los productos o especificaciones en cualquier momento sin previo aviso. Puesto que las especificaciones, equipos u opciones pueden no ser las mismas en todos los mercados, solicite información a su distribuidor Yamaha.

\* As especificações e as descrições contidas neste manual do proprietário têm apenas fins informativos. A Yamaha Corp. reserva-se o direito de alterar ou modificar produtos ou especificações a qualquer momento, sem notificação prévia. Como as especificações, os equipamentos ou as opções podem não ser iguais em todas as localidades, verifique esses itens com o revendedor Yamaha.

\* Le specifiche e le descrizioni presenti in questo manuale sono fornite a fini puramente informativi. Yamaha Corp. si riserva il diritto di modificare prodotti o specifiche in qualsiasi momento senza preavviso. Dato che le specifiche, le apparecchiature o le opzioni possono essere diverse da paese a paese, verificarle con il proprio rappresentante Yamaha.

\* Технические характеристики и их описания в данном руководстве пользователя предназначены только для общего сведения. Корпорация Yamaha сохраняет за собой право модифицировать свои изделия и менять их технические характеристики без предварительного уведомления. Поскольку технические характеристики, оборудование и набор возможностей могут зависеть от региона, обращайтесь за информацией к местному представителю корпорации Yamaha.

\* 本使用说明书中的技术规格及介绍仅供参考。Yamaha公司保留随时更改或修订产品或技术规格的权利，若确有更改，恕不事先通知。技术规格、设备或选购件在各个地区可能均会有所不同，因此如有问题，请与当地Yamaha经销商确认。

\* 仕様および外観は、改良のため予告なく変更することがあります。

# Specifications

Model	HS8	HS7	HS5	HS8S	
<b>General Specifications</b>					
Type	Bi-amp 2-way powered speaker			Powered subwoofer	
Crossover Frequency	2 kHz			–	
Overall Frequency Response	-3dB	47 Hz – 24 kHz	55 Hz – 24 kHz	74 Hz – 24 kHz	33 Hz – 124 Hz
	-10dB	38 Hz – 30 kHz	43 Hz – 30 kHz	54 Hz – 30 kHz	22 Hz – 160 Hz
Dimensions (W x H x D)	250 x 390 x 334 mm 9-13/16 x 15-3/8 x 13-1/8"	210 x 332 x 284 mm 8-1/4 x 13-1/16 x 11-3/16"	170 x 285 x 222 mm 6-11/16 x 11-1/4 x 8-3/4"	300 x 350 x 389 mm 11-13/16 x 13-3/4 x 15-5/16"	
Weight	10.2 kg (22.5 lb.)	8.2 kg (18.1 lb.)	5.3 kg (11.7 lb.)	12.5 kg (27.6 lb.)	
<b>Speaker Components</b>					
Speaker Components	LF: 8" cone HF: 1" dome	LF: 6.5" cone HF: 1" dome	LF: 5" cone HF: 1" dome	8" cone	
Enclosure	Bass-reflex type, Material: MDF				
<b>Amplifier Unit</b>					
Output Power	Total	120 W (dynamic power)	95 W (dynamic power)	70 W (dynamic power)	150 W, 4 ohms (dynamic power)
	LF	75 W (4 ohms)	60 W (4 ohms)	45 W (4 ohms)	–
	HF	45 W (8 ohms)	35 W (8 ohms)	25 W (8 ohms)	–
Input Sensitivity / Impedance	-10 dBu/10k ohms				
Output Level/Impedance	–			-10 dBu/600 ohms	
Input Connectors (Parallel)	1: XLR-3-31 type (balanced) 2: PHONE (balanced)				
Output Connectors	–			XLR-3-32 type (balanced) x2 (L&R)	
Controls	LEVEL control (+4 dB, center click) EQ: HIGH TRIM switch (+/- 2 dB at HF), ROOM CONTROL switch (0/-2/-4 dB under 500Hz)			LEVEL control PHASE switch (NORM./REV.) HIGH CUT control (80 – 120 Hz, center click) LOW CUT control (80 – 120 Hz, center click) LOW CUT switch (ON/OFF)	
Indicator	Power ON (White LED)				
Power Consumption	60 W	55 W	45 W	70 W	

# Dimensions

## HS8

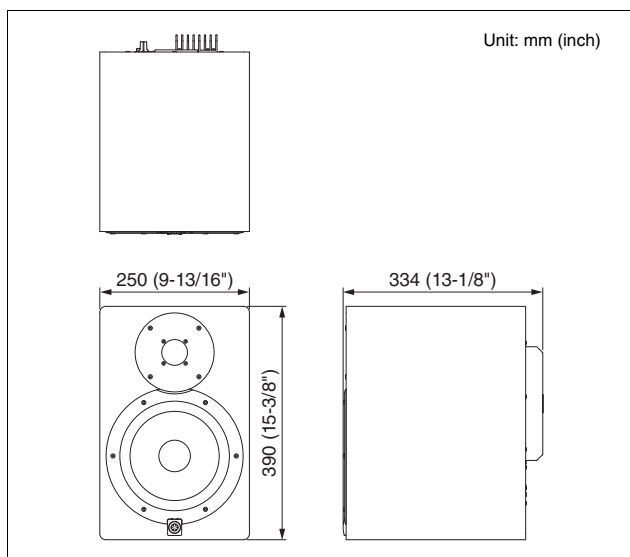

## HS7

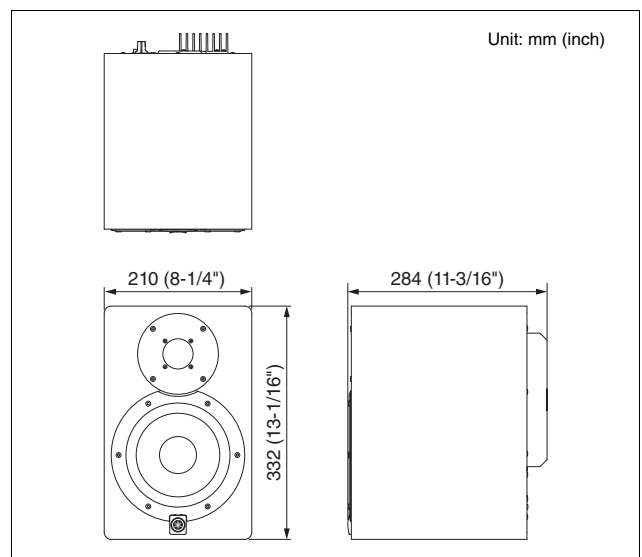



## HS5

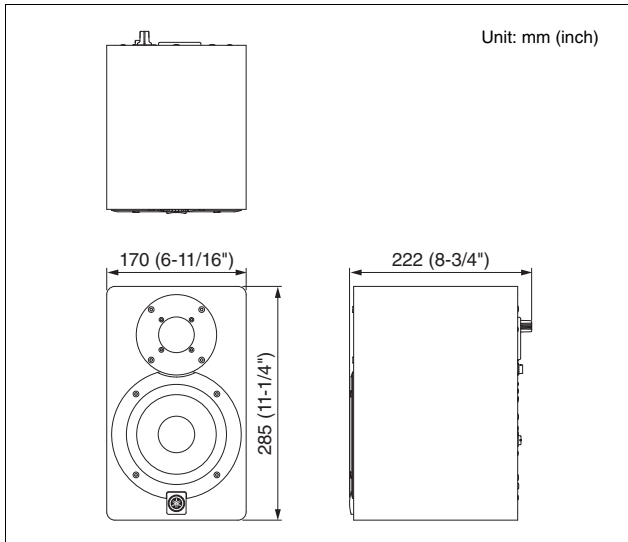

## HS8S

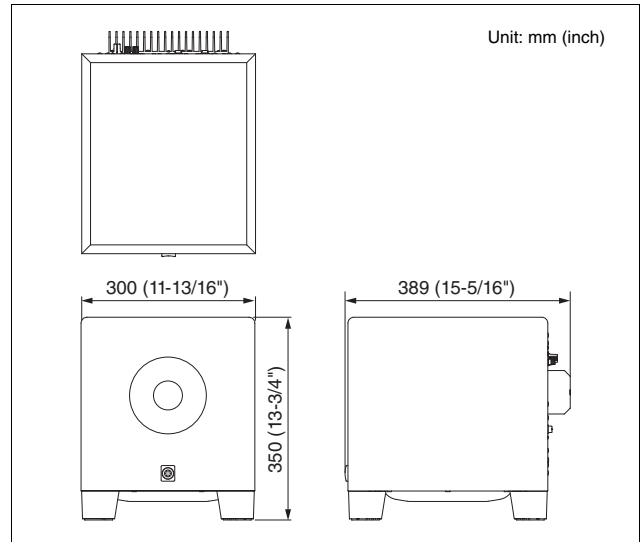

# Performance Graph

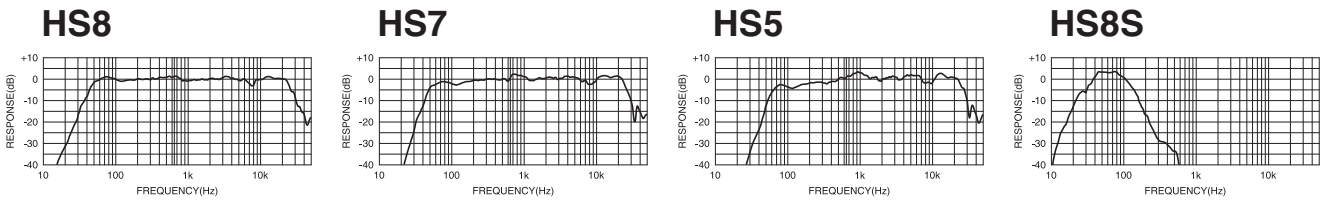

# Block Diagram

## HS8/HS7/HS5

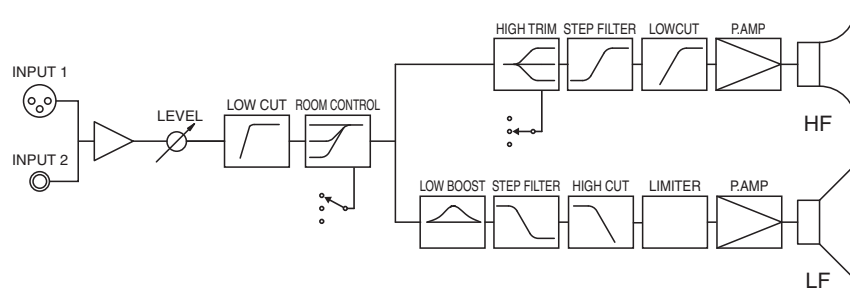

## HS8S

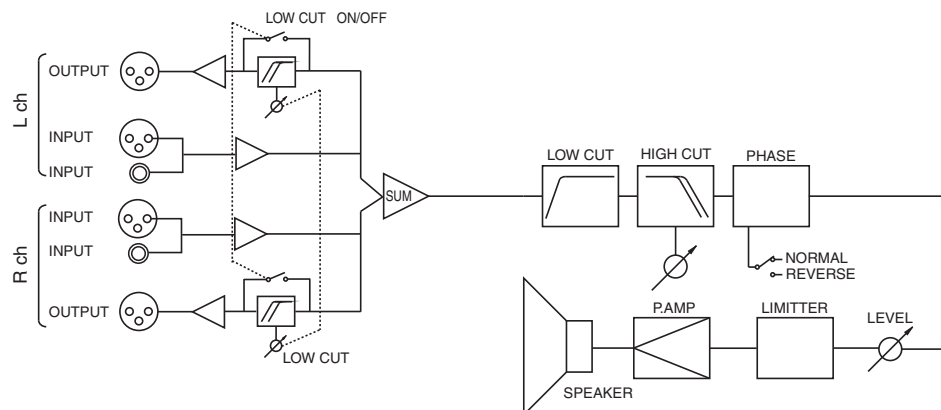

# Important Notice: Guarantee Information for customers in European Economic Area (EEA) and Switzerland

<b>Important Notice: Guarantee Information for customers in EEA* and Switzerland</b> For detailed guarantee information about this Yamaha product, and Pan-EEA* and Switzerland warranty service, please either visit the website address below (Printable file is available at our website) or contact the Yamaha representative office for your country. * EEA: European Economic Area	<b>English</b>
<b>Wichtiger Hinweis: Garantie-Information für Kunden in der EWR* und der Schweiz</b> Für nähere Garantie-Information über dieses Produkt von Yamaha, sowie über den Pan-EWR*- und Schweizer Garantieservice, besuchen Sie bitte entweder die folgende angegebene Internetadresse (eine druckfähige Version befindet sich auch auf unserer Webseite), oder wenden Sie sich an den für Ihr Land zuständigen Yamaha-Vertrieb. *EWR: Europäischer Wirtschaftsraum	<b>Deutsch</b>
<b>Remarque importante: informations de garantie pour les clients de l'EEE et la Suisse</b> Pour des informations plus détaillées sur la garantie de ce produit Yamaha et sur le service de garantie applicable dans l'ensemble de l'EEE ainsi qu'en Suisse, consultez notre site Web à l'adresse ci-dessous (le fichier imprimable est disponible sur notre site Web) ou contactez directement Yamaha dans votre pays de résidence. * EEE : Espace Economique Européen	<b>Français</b>
<b>Belangrijke mededeling: Garantie-informatie voor klanten in de EER* en Zwitserland</b> Voor gedetailleerde garantie-informatie over dit Yamaha-product en de garantieservice in heel de EER* en Zwitserland, gaat u naar de onderstaande website (u vindt een afdrukbaar bestand op onze website) of neemt u contact op met de vertegenwoordiging van Yamaha in uw land. * EER: Europese Economische Ruimte	<b>Nederlands</b>
<b>Aviso importante: información sobre la garantía para los clientes del EEE* y Suiza</b> Para una información detallada sobre este producto Yamaha y sobre el soporte de garantía en la zona EEE* y Suiza, visite la dirección web que se incluye más abajo (la versión del archivo para imprimir esta disponible en nuestro sitio web) o póngase en contacto con el representante de Yamaha en su país. * EEE: Espacio Económico Europeo	<b>Español</b>
<b>Avviso importante: informazioni sulla garanzia per i clienti residenti nell'EEA* e in Svizzera</b> Per informazioni dettagliate sulla garanzia relativa a questo prodotto Yamaha e l'assistenza in garanzia nei paesi EEA* e in Svizzera, potete consultare il sito Web all'indirizzo riportato di seguito (è disponibile il file in formato stampabile) oppure contattare l'ufficio di rappresentanza locale della Yamaha. * EEA: Area Economica Europea	<b>Italiano</b>
<b>Aviso importante: informações sobre as garantias para clientes da AEE* e da Suíça</b> Para obter uma informação pormenorizada sobre este produto da Yamaha e sobre o serviço de garantia na AEE* e na Suíça, visite o site a seguir (o arquivo para impressão está disponível no nosso site) ou entre em contato com o escritório de representação da Yamaha no seu país. * AEE: Área Económica Européia	<b>Português</b>
<b>Σημαντική σημείωση: Πληροφορίες εγγύησης για τους πελάτες στον ΕΟΧ* και Ελλάδα</b> Για λεπτομερείς πληροφορίες εγγύησης σχετικά με το παρόν προϊόν της Yamaha και την κάλυψη εγγύησης σε όλες τις χώρες του ΕΟΧ και την Ελλάδα, επισκεφτείτε την παρακάτω ιστοσελίδα (Εκτυπώσιμη μορφή είναι διαθέσιμη στην ιστοσελίδα μας) ή απευθυνθείτε στην αντιπροσωπεία της Yamaha στη χώρα σας. * ΕΟΧ: Ευρωπαϊκός Οικονομικός Χώρος	<b>Ελληνικά</b>
<b>Viktigt: Garantiinformation för kunder i EES-området* och Schweiz</b> För detaljerad information om denna Yamaha-produkt samt garantiservice i hela EES-området* och Schweiz kan du antingen besöka nedanstående webbadress (en utskriftsvänlig fil finns på webbplatsen) eller kontakta Yamahas officiella representant i ditt land. * EES: Europeiska Ekonomiska Samarbetsområdet	<b>Svenska</b>
<b>Viktig merknad: Garantiinformasjon for kunder i EØS* og Sveits</b> Detaljert garantiinformasjon om dette Yamaha-produktet og garantiservice for hele EØS-området* og Sveits kan fås enten ved å besøke nettstedene nedenfor (utskriftsversjon finnes på våre nettsider) eller kontakte Yamahas kontoret i landet der du bor. *EØS: Det europeiske økonomiske samarbeidsområdet	<b>Norsk</b>
<b>Vigtig oplysning: Garantioplysninger til kunder i EØ* og Schweiz</b> De kan finde detaljerede garantioplysninger om dette Yamaha-produkt og den fælles garantiserviceordning for EØ* (og Schweiz) ved at besøge det websted, der er angivet nedenfor (der findes en fil, som kan udskrives, på vores websted), eller ved at kontakte Yamahas nationale repræsentationskontor i det land, hvor De bor. * EØ: Det Europæiske Økonomiske Område	<b>Dansk</b>
<b>Tärkeä ilmoitus: Takuutiedot Euroopan talousalueen (ETA)* ja Sveitsin asiakkaille</b> Tämän Yamaha-tuotteen sekä ETA-alueen ja Sveitsin takuuta koskevat yksityiskohtaiset tiedot saatte alla olevasta nettosoitteesta. (Tulostettava tiedosto saatavissa sivustollamme.) Voitte myös ottaa yhteyttä paikalliseen Yamaha-edustajaan. *ETA: Euroopan talousalue	<b>Suomi</b>
<b>Ważne: Warunki gwarancyjne obowiązujące w EOG* i Szwajcarii</b> Aby dowiedzieć się więcej na temat warunków gwarancyjnych tego produktu firmy Yamaha i serwisu gwarancyjnego w całym EOG* i Szwajcarii, należy odwiedzić wskazaną poniżej stronę internetową (Plik gotowy do wydruku znajduje się na naszej stronie internetowej) lub skontaktować się z przedstawicielstwem firmy Yamaha w swoim kraju. * EOG — Europejski Obszar Gospodarczy	<b>Polski</b>
<b>Důležité oznámení: Záruční informace pro zákazníky v EHS* a ve Švýcarsku</b> Podrobné záruční informace o tomto produktu Yamaha a záručním servisu v celém EHS* a ve Švýcarsku naleznete na níže uvedené webové adrese (soubor k tisku je dostupný na našich webových stránkách) nebo se můžete obrátit na zastoupení firmy Yamaha ve své zemi. * EHS: Evropský hospodářský prostor	<b>Česky</b>
<b>Fontos figyelemztetés: Garancia-információk az EGT* területén és Svájcban élő vásárlók számára</b> A jelen Yamaha termékre vonatkozó részletes garancia-információk, valamint az EGT*-re és Svájcra kiterjedő garanciális szolgáltatás tekintetében keresse fel webhelyünket az alábbi címen (a webhelyen nyomtatható fájl is található), vagy pedig lépjen kapcsolatba az országában működő Yamaha képviseleti irodával. * EGT: Európai Gazdasági Térség	<b>Magyar</b>
<b>Oluline märkus: Garantiteave Euroopa Majanduspiirkonna (EMP)* ja Šveitsi klientidele</b> Täpsema teabe saamiseks selle Yamaha toote garantii ning kogu Euroopa Majanduspiirkonna ja Šveitsi garantiteeninduse kohta, külastage palun veebisaiti alljärgneval aadressil (meie saidil on saadaval printitav fail) või pöörduge Teie regioonil Yamaha esinduse poole. * EMP: Euroopa Majanduspiirkond	<b>Eesti keel</b>
<b>Svarīgs paziņojums: garantijas informācija klientiem EEZ* un Šveicē</b> Lai saņemtu detalizētu garantijas informāciju par šo Yamaha produktu, kā arī garantijas apkalpošanu EEZ* un Šveicē, lūdzu, apmeklējiet zemāk norādīto tīmekļa vietnes adresi (tīmekļa vietni ir pieejams drukājams fails) vai sazinieties ar jūsu valsti apkalpojošo Yamaha pārstāvniecību. * EEZ: Eiropas Ekonomikas zona	<b>Latviešu</b>
<b>Dėmesio: informacija dėl garantijos pirkėjams EEE* ir Šveicarijoje</b> Jei reikia išsamios informacijos apie šį „Yamaha“ produktą ir jo techninę priežiūrą visoje EEE* ir Šveicarijoje, apsilankykite mūsų svetainėje toliau nurodytu adresu (svetainėje yra spausdintinas failas) arba kreipkitės į „Yamaha“ atstovybę savo šaliai. *EEE – Europos ekonominė erdvė	<b>Lietuvių kalba</b>
<b>Dôležité upozornenie: Informácie o záruke pre zákazníkov v EHP* a Švajčiarsku</b> Podrobné informácie o záruke týkajúce sa tohto produktu od spoločnosti Yamaha a garančnom servise v EHP* a Švajčiarsku nájdete na webovej stránke uvedenej nižšie (na našej webovej stránke je k dispozícii súbor na tlač) alebo sa obráťte na zástupcu spoločnosti Yamaha vo svojej krajine. * EHP: Európsky hospodársky priestor	<b>Slovenčina</b>
<b>Pomembno obvestilo: Informacije o garanciji za kupce v EGP* in Švici</b> Za podrobnejše informacije o tem Yamahinem izdelku ter garancijskem servisu v celotnem EGP in Švici, obiščite spletno mesto, ki je navedeno spodaj (natisljiva datoteka je na voljo na našem spletnem mestu), ali se obrnite na Yamahinega predstavnika v svoji državi. * EGP: Evropski gospodarski prostor	<b>Slovenščina</b>
<b>Важно съобщение: Информация за гаранцията за клиенти в ЕИП* и Швейцария</b> За подробна информация за гаранцията за този продукт на Yamaha и гаранционното обслужване в паневропейската зона на ЕИП* и Швейцария или посетете посочения по-долу уеб сайт (на нашия уеб сайт има файл за печат), или се свържете с представителния офис на Yamaha във вашата страна. * ЕИП: Европейско икономическо пространство	<b>Български език</b>
<b>Notificare importantă: Informații despre garanție pentru clienții din SEE* și Elveția</b> Pentru informații detaliate privind acest produs Yamaha și serviciul de garanție Pan-SEE* și Elveția, vizitați site-ul la adresa de mai jos (fișierul imprimabil este disponibil pe site-ul nostru) sau contactați biroul reprezentanței Yamaha din țara dumneavoastră. * SEE: Spațiul Economic European	<b>Limba română</b>

<http://europe.yamaha.com/warranty/>

For details of products, please contact your nearest Yamaha representative or the authorized distributor listed below.

Pour plus de détails sur les produits, veuillez-vous adresser à Yamaha ou au distributeur le plus proche de vous figurant dans la liste suivante.

Die Einzelheiten zu Produkten sind bei Ihrer unten aufgeführten Niederlassung und bei Yamaha Vertragshändlern in den jeweiligen Bestimmungsländern erhältlich.

Para detalles sobre productos, contacte su tienda Yamaha más cercana o el distribuidor autorizado que se lista debajo.

## NORTH AMERICA

### CANADA

**Yamaha Canada Music Ltd.**  
135 Milner Avenue, Scarborough, Ontario,  
M1S 3R1, Canada  
Tel: 416-298-1311

### U.S.A.

**Yamaha Corporation of America**  
6600 Orangethorpe Ave., Buena Park, Calif. 90620,  
U.S.A.  
Tel: 714-522-9011

## CENTRAL & SOUTH AMERICA

### MEXICO

**Yamaha De México, S.A. de C.V.**  
Av. Insurgentes Sur 1647 "Prisma Insurgentes",  
Col. San José Insurgentes, Del. Benito Juárez,  
03900, México, D.F.  
Tel: 55-5804-0600

### BRAZIL

**Yamaha Musical do Brasil Ltda.**  
Rua Joaquim Floriano, 913 - 4º andar, Itaim Bibi,  
CEP 04534-013 Sao Paulo, SP. BRAZIL  
Tel: 011-3704-1377

### ARGENTINA

**Yamaha Music Latin America, S.A.  
Sucursal de Argentina**  
Olga Cossetini 1553, Piso 4 Norte  
Madero Este-C1107CEK  
Buenos Aires, Argentina  
Tel: 011-4119-7000

### PANAMA AND OTHER LATIN

### AMERICAN COUNTRIES/

### CARIBBEAN COUNTRIES

**Yamaha Music Latin America, S.A.**  
Torre Banco General, Piso 7, Urbanización Marbella,  
Calle 47 y Aquilino de la Guardia,  
Ciudad de Panamá, Panamá  
Tel: +507-269-5311

## EUROPE

### THE UNITED KINGDOM/IRELAND

**Yamaha Music Europe GmbH (UK)**  
Sherbourne Drive, Tilbrook, Milton Keynes,  
MK7 8BL, England  
Tel: 01908-366700

### GERMANY

**Yamaha Music Europe GmbH**  
Siemensstraße 22-34, 25462 Rellingen, Germany  
Tel: 04101-3030

### SWITZERLAND/LIECHTENSTEIN

**Yamaha Music Europe GmbH  
Branch Switzerland in Zürich**  
Seefeldstrasse 94, 8008 Zürich, Switzerland  
Tel: 044-387-8080

### AUSTRIA/BULGARIA

**Yamaha Music Europe GmbH Branch Austria**  
Schleiergasse 20, A-1100 Wien, Austria  
Tel: 01-60203900

### CZECH REPUBLIC/HUNGARY/

### ROMANIA/SLOVAKIA/SLOVENIA

**Yamaha Music Europe GmbH  
Branch Austria (Central Eastern Europe Office)**  
Schleiergasse 20, A-1100 Wien, Austria  
Tel: 01-602039025

### POLAND/LITHUANIA/LATVIA/ESTONIA

**Yamaha Music Europe GmbH  
Branch Poland Office**  
ul. Wrotkowa 14 02-553 Warsaw, Poland  
Tel: 022-500-2925

### MALTA

**Olimpus Music Ltd.**  
The Emporium, Level 3, St. Louis Street Msida  
MSD06  
Tel: 02133-2144

### THE NETHERLANDS/ BELGIUM/LUXEMBOURG

**Yamaha Music Europe Branch Benelux**  
Clarissenhof 5-b, 4133 AB Vianen, The Netherlands  
Tel: 0347-358 040

### FRANCE

**Yamaha Music Europe**  
BP 70-77312 Marne-la-Vallée Cedex 2, France  
Tel: 01-64-61-4000

### ITALY

**Yamaha Music Europe GmbH, Branch Italy**  
Viale Italia 88, 20020 Lainate (Milano), Italy  
Tel: 02-935-771

### SPAIN/PORTUGAL

**Yamaha Music Europe GmbH Ibérica, Sucursal  
en España**  
Ctra. de la Coruna km. 17, 200, 28230  
Las Rozas (Madrid), Spain  
Tel: +34-902-39-8888

### GREECE

**Philippos Nakas S.A. The Music House**  
147 Skiathou Street, 112-55 Athens, Greece  
Tel: 01-228 2160

### SWEDEN/FINLAND/ICELAND

**Yamaha Music Europe GmbH Germany filial  
Scandinavia**  
J. A. Wettergrens Gata 1, Box 30053  
S-400 43 Göteborg, Sweden  
Tel: 031 89 34 00

### DENMARK

**Yamaha Music Europe GmbH, Tyskland – filial  
Denmark**  
Generatorvej 6A, DK-2730 Herlev, Denmark  
Tel: 44 92 49 00

### NORWAY

**Yamaha Music Europe GmbH Germany -  
Norwegian Branch**  
Grini Næringspark 1, N-1345 Østerås, Norway  
Tel: 67 16 77 70

### RUSSIA

**Yamaha Music (Russia)**  
Room 37, bld. 7, Kievskaya street, Moscow,  
121059, Russia  
Tel: 495 626 5005

### OTHER EUROPEAN COUNTRIES

**Yamaha Music Europe GmbH**  
Siemensstraße 22-34, 25462 Rellingen, Germany  
Tel: +49-4101-3030

## AFRICA

**Yamaha Corporation,  
Asia-Pacific Sales & Marketing Group**  
Nakazawa-cho 10-1, Naka-ku, Hamamatsu,  
Japan 430-8650  
Tel: +81-53-460-2303

## MIDDLE EAST

### TURKEY/CYPRUS

**Yamaha Music Europe GmbH**  
Siemensstraße 22-34, 25462 Rellingen, Germany  
Tel: 04101-3030

### OTHER COUNTRIES

**Yamaha Music Gulf FZE**  
LOB 16-513, P.O.Box 17328, Jubel Ali,  
Dubai, United Arab Emirates  
Tel: +971-4-881-5868

## ASIA

### THE PEOPLE'S REPUBLIC OF CHINA

**Yamaha Music & Electronics (China) Co.,Ltd.**  
2F, Yunhedasha, 1818 Xinzha-lu, Jingan-qu,  
Shanghai, China  
Tel: 021-6247-2211

### INDIA

**Yamaha Music India Pvt. Ltd.**  
Spazedge building, Ground Floor, Tower A, Sector  
47, Gurgaon- Sohna Road, Gurgaon, Haryana, India  
Tel: 0124-485-3300

### INDONESIA

**PT. Yamaha Musik Indonesia (Distributor)**

**PT. Nusantara**  
Gedung Yamaha Music Center, Jalan Jend. Gatot  
Subroto Kav. 4, Jakarta 12930, Indonesia  
Tel: 021-520-2577

### KOREA

**Yamaha Music Korea Ltd.**  
8F, 9F, Dongsung Bldg. 158-9 Samsung-Dong,  
Kangnam-Gu, Seoul, Korea  
Tel: 02-3467-3300

### MALAYSIA

**Yamaha Music (Malaysia) Sdn., Bhd.**  
Lot 8, Jalan Perbandaran, 47301 Kelana Jaya,  
Petaling Jaya, Selangor, Malaysia  
Tel: 03-78030900

### SINGAPORE

**Yamaha Music (Asia) PRIVATE LIMITED**  
Blk 202 Hougang Street 21, #02-00,  
Singapore 530202, Singapore  
Tel: 6747-4374

### TAIWAN

**Yamaha KHS Music Co., Ltd.**  
3F, #6, Sec.2, Nan Jing E. Rd. Taipei.  
Taiwan 104, R.O.C.  
Tel: 02-2511-8688

### THAILAND

**Siam Music Yamaha Co., Ltd.**  
4, 6, 15 and 16th floor, Siam Motors Building,  
891/1 Rama 1 Road, Wangmai,  
Pathumwan, Bangkok 10330, Thailand  
Tel: 02-215-2622

### OTHER ASIAN COUNTRIES

**Yamaha Corporation,  
Asia-Pacific Sales & Marketing Group**  
Nakazawa-cho 10-1, Naka-ku, Hamamatsu,  
Japan 430-8650  
Tel: +81-53-460-2303

## OCEANIA

### AUSTRALIA

**Yamaha Music Australia Pty. Ltd.**  
Level 1, 99 Queensbridge Street, Southbank,  
Victoria 3006, Australia  
Tel: 3-9693-5111

### COUNTRIES AND TRUST

### TERRITORIES IN PACIFIC OCEAN

**Yamaha Corporation,  
Asia-Pacific Sales & Marketing Group**  
Nakazawa-cho 10-1, Naka-ku, Hamamatsu,  
Japan 430-8650  
Tel: +81-53-460-2303



Yamaha Pro Audio global web site  
<http://www.yamahaproaudio.com/>

Yamaha Manual Library  
<http://www.yamaha.co.jp/manual/>

C.S.G., Pro Audio Division  
© 2013 Yamaha Corporation

303MWCR\*.\*-\*\*A0  
Printed in Indonesia

ZF69500