



## FOS Odeum Wash

# User Manual



# Please read the instruction carefully before use

## TABLE OF CONTENTS

1. Safety Instructions.....	2
2. Technical Specifications.....	3
3. How To Set The Unit.....	4
3.1 Control panel.....	4
3.2 Main Function.....	5
3.3 Home Position Adjustment.....	13
4. Control By Universal DMX Controller.....	13
4.1 DMX 512 Connection.....	13
4.2 Address Setting.....	14
4.3 DMX 512 Configuration.....	16
5. Troubleshooting.....	20
6. Fixture Cleaning.....	20

## 1. Safety Instructions



**WARNING**

Please read the instruction carefully which includes important information about the installation, usage and maintenance.

Please keep this User Manual for future consultation. If you sell the unit to another user, be sure that they also receive this instruction booklet.

- Unpack and check carefully there is no transportation damage before using the unit.
- Before operating, ensure that the voltage and frequency of power supply match the power requirements of the unit.
- It's important to ground the yellow/green conductor to earth in order to avoid electric shock.
- The unit is for indoor use only. Use only in a dry location.
- The unit must be installed in a location with adequate ventilation, at least 50cm from adjacent surfaces. Be sure that no ventilation slots are blocked.
- Disconnect main power before replacement or servicing.
- Make sure there are no flammable materials close to the unit while operating as it is fire hazard.
- Use safety cables when fixing this unit. DO NOT handle the unit by its head only, always carry by its base.
- Maximum ambient temperature is  $T_a$ : 40 degrees C. DO NOT operate it where the temperature is higher than this.
- Unit surface temperature may reach up to 75 degrees C. DO NOT touch the housing with bare-hands during its operation.  
Turn off the power and allow about 15 minutes for the unit to cool down before replacing or serving.
- In the event of a serious operating problem, stop using the unit immediately. Never try to repair the unit by yourself.  
Repairs carried out by unskilled people can lead to damage or malfunction. Please contact the nearest authorized technical assistance center. Always use the same type spare parts.
- DO NOT touch any wire during operation as high voltage may cause electric shock.

### **Warning:**

- To prevent or reduce the risk of electrical shock or fire, do not expose the unit to rain or moisture.
- The housing and lenses must be replaced if they are visibly damaged.

### **Caution:**

There are no user serviceable parts inside the unit. Do not open the housing or attempt any repairs yourself.

In the unlikely event your unit may require service, please contact your nearest dealer.

### Installation:

The fixture should be mounted via its Omega Quick Release Clamp bracket. Always ensure that the unit is firmly fixed to avoid vibration and slipping while operating and make sure that the structure to which you are attaching the unit is secure and is able to support a weight of 10 times of the fixtures weight. Always use a safety cable that can hold 12 times of the weight of the fixture when installing.

The equipment must be installed by professionals. It must be installed in a place where is out of the reach of people and no one can pass by or under it.

## 2. Technical Specifications

*CR Imore than 94/95*

*CTO linear adjust 2200-10000K*

*Extremely small, fast and powerful LED moving beam.*

*DMX Channels: 14/27 channels mode*

*Color macro effect*

*Variable strobe effects*

*Blue white LCD display for easy navigation*

*Perfect for stage, theatre, TV studio, rental and discotheques*

- ◇ **Input Voltage:** AC 100 ~ 240V, 50/60Hz
- ◇ **Power Consumption:** 430W
- ◇ **Power Cable Daisy Chain:** 9 Fixture Max. (230V, 50Hz) 5 Fixture Max. (120V, 60Hz)
- ◇ **LED Source:** 19x 25W
- ◇ **Beam Angel:** 10° ~ 60°
- ◇ **Weight:** 9.5Kgs
- ◇ **Dimension:** 350 × 200 × 400mm

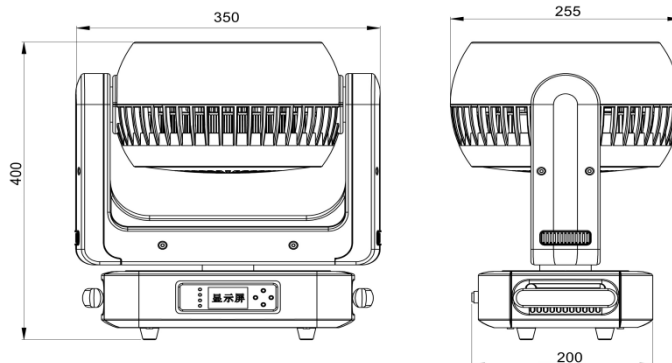

### 3. How To Set The Unit

#### 3.1 Control panel

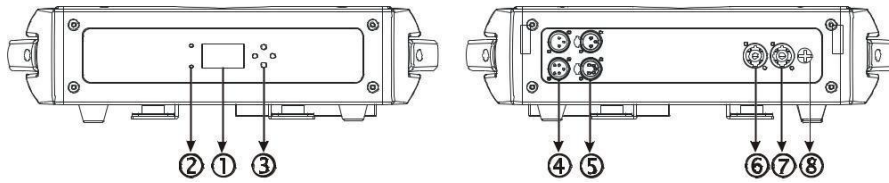

##### 1. Function Display:

Shows the various menus and the selected functions

##### 2. LED:

POWER	ON	Power On
DMX	ON	DMX input present

##### 3. Button:

MENU	To select the programming functions
▼ DOWN	To go backward in the selected functions
▲ UP	To go forward in the selected functions
ENTER	To confirm the selected functions

##### 4. DMX IN:

DMX512 link, use 3/5-pin XLR cable to link the unit and the DMX controller

##### 5. DMX OUT:

DMX512 link, use 3/5-pin XLR cable to link the next unit and output DMX signal

##### 6. MAINS IN:

PowerCon connection from main power supply

##### 7. MAINS OUT:

PowerCon loop connection for main power supply to the next unit

##### 8. Fuse (T 10A):

Protects the unit from over-voltage or short circuit

#### 3.2 Main Functions

To select any of the given functions, press the **MENU** button until the required function is showing on the display.

Select the function by pressing the **ENTER** button and the display will blink. Use the

**DOWN/UP** buttons to change the mode. Once the required mode has been selected, press the **ENTER** button

to setup, to go back to the functions without any change press the **MENU** button again. Press and hold the

**MENU** button for about one second or wait for one minute to exit the menu mode.

The main functions are shown overleaf:

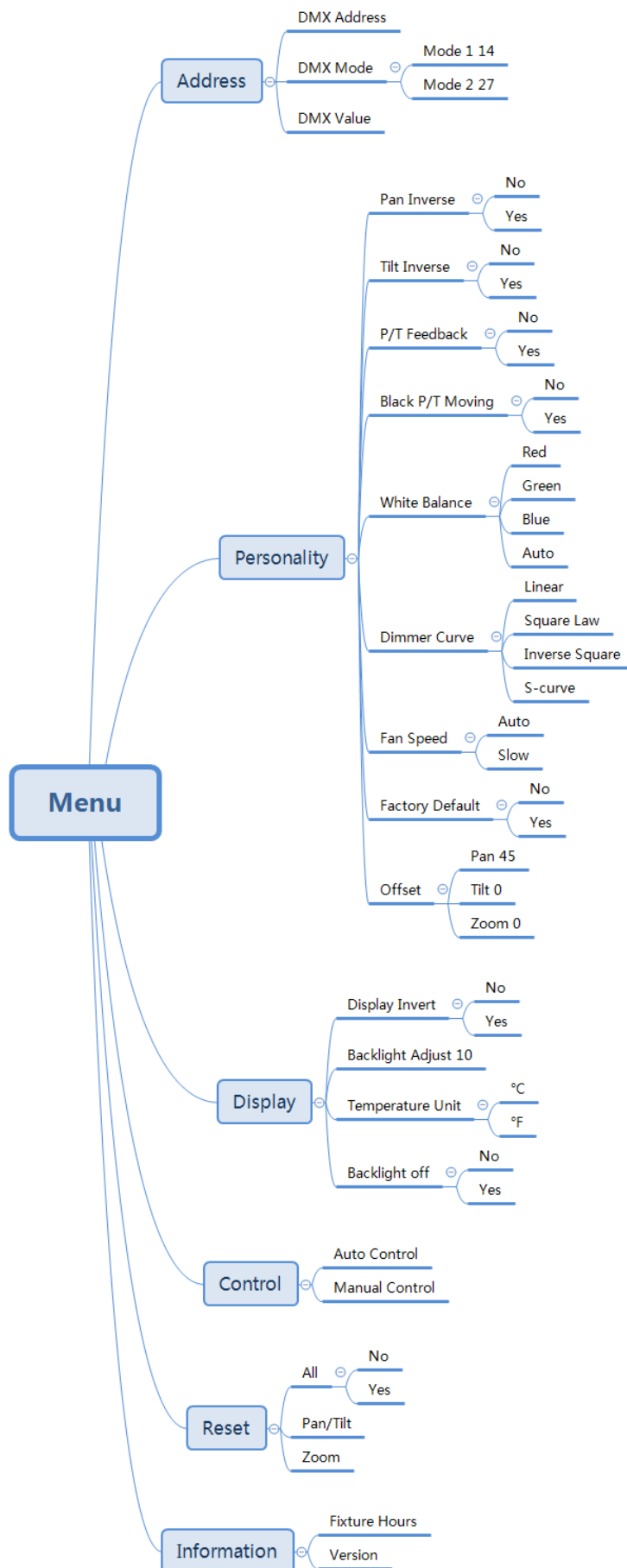

### **DMX Functions**

Enter MENU mode, select **DMX Functions**, press the **ENTER** button to confirm, use the **UP/DOWN** button to select **DMX Address, DMX Channel Mode** or **View DMX Value**.

#### **DMX Address**

To select **DMX Address**, press the **ENTER** button to show the **DMX ADDRESS** on the display. Use the **UP/DOWN** button to adjust the address from **001** to **512**, press the **ENTER** button to setup. Press the **MENU** button back to the last menu or let the unit idle one minute to exit menu mode.

#### **DMX Channel Mode**

To select **DMX Channel Mode**, press the **ENTER** button to show the **DMX CHANNEL MODE** on the display. Use the **UP/DOWN** button to select **Mode1 (14)** or **Mode2 (27)**, and press the **ENTER** button to setup. Press the **MENU** button back to the last menu or let the unit idle one minute to exit menu mode.

#### **View DMX Value**

To select **View DMX Value**, press the **ENTER** button to show the **VIEW DMX VALUE** on the display. Use the **UP/DOWN** button to view the DMX channel values. Press the **MENU** button back to the last menu or let the unit idle one minute to exit menu mode.

### **Fixture Setting**

Enter MENU mode, select **Fixture Setting**, press the **ENTER** button to confirm, use the **UP/DOWN** button to select **Pan Inverse, Tilt Inverse, P/T Feedback, B.L.O. P/T Moving, White Balance, Cooling Mode, Dimmer Curve** or **Dimmer Speed**.

#### **Pan Inverse**

To select **Pan Inverse**, press the **ENTER** button to show the **PAN INVERSE** on the display. Use the **UP/DOWN** button to select **No** (normal) or **Yes** (pan inverse), press the **ENTER** button to setup. Press the **MENU** button back to the last menu or let the unit idle one minute to exit menu mode.

#### **Tilt Inverse**

To select **Tilt Inverse**, press the **ENTER** button to show the **TILT INVERSE** on the display. Use the **UP/DOWN** button to select **No** (normal) or **Yes** (tilt inverse), press the **ENTER** button to setup. Press the **MENU** button back to the last menu or let the unit idle one minute to exit menu mode.

### P/T Feedback

To select **P/T Feedback**, press the **ENTER** button to show the **PAN/TILT FEEDBACK** on the display. Use the **UP/DOWN** button to select **No** (Pan or tilt's position will not feedback while out of step) or **Yes** (Feedback while pan/tilt out of step), press the **ENTER** button to setup. Press the **MENU** button back to the last menu or let the unit idle one minute to exit menu mode.

### BL.O. P/T Moving

To select **BL.O. P/T Moving**, press the **ENTER** button to show the **BLACKOUT WHILE PAN/TILT MOVING** on the display, use the **UP/DOWN** button to select **No** (normal while pan/tilt moving) or **Yes** (blackout while pan/tilt moving), press the **ENTER** button to setup. Press the **MENU** button back to the last menu or let the unit idle one minute to exit menu mode.

### White Balance

To select **White Balance**, press the **ENTER** button to show the **WHITE BALANCE** on the display, use the **UP/DOWN** button to select **Red**, **Green** or **Blue**. Once selected, press the **ENTER** button to confirm, and use the **UP/DOWN** button to adjust the value from **125** to **255**, press the **ENTER** button to setup. Press the **MENU** button back to the last menu or let the unit idle one minute to exit menu mode.

### Cooling Mode

To select **Cooling Mode**, press the **ENTER** button to show the **COOLING MODE** on the display. Use the **UP/DOWN** button to select **Auto** (Normal) or **Low** (Low speed). Once selected, press the **ENTER** button to setup. Press the **MENU** button back to the last menu or let the unit idle one minute to exit menu mode.

### Dimmer Curve

To select **Dimmer Curve**, press the **ENTER** button to show the **DIMMER CURVE** on the display, use the **UP/DOWN** button to select **Linear**, **Square Law**, **Inverse Squ.** or **S-curve**. Once selected, press the **ENTER** button to store. Press the **MENU** button back to the last menu or let the unit idle one minute to exit menu mode.

Dimmer Modes:

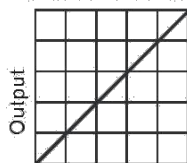

(Optically Linear)

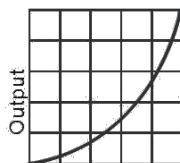

(Square Law)

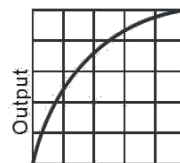

(Inverse Square Law)

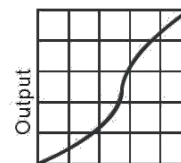

(S-Curve)



**Square Law:** Light intensity control is finer at low levels and coarser at high levels.

**Inverse Square Law:** Light intensity control is coarser at low levels and finer at high levels.

**S-cure:** Light intensity control is finer at low levels and high levels and coarser at medium levels.

#### **Dimmer Speed**

To select **Dimmer Speed**, press the **ENTER** button to show the **DIMMER SPEED** on the display. Use the **UP/DOWN** button to select Fast or Smooth. Once selected, press the **ENTER** button to setup. Press the **MENU** button back to the last menu or let the unit idle one minute to exit menu mode.

#### **Display Setting**

Enter **MENU** mode, select Display Setting, press the **ENTER** button to confirm, use the **UP/DOWN** button to select **Display Inverse, Backlight Auto Off, Backlight Intensity, Temperature unit or Display Warning.**

#### **Display Inverse**

To select **Display Inverse**, press the **ENTER** button to show the **DISPLAY INVERSE** on the display. Use the **UP/DOWN** button to select **No** (normal) or **Yes** (display inverse). Once selected, press the **ENTER** button to store. Press the **MENU** button back to the last menu or let the unit idle one minute to exit menu mode.

#### **Backlight Auto Off**

To select **Backlight Auto Off**, press the **ENTER** button to show the **BACKLIGHT AUTO OFF** on the display. Use the **UP/DOWN** button to select **No** (display always on) or **Yes** (display goes off one minute after exiting menu mode). Once selected, press the **ENTER** button to confirm and store. Press the **MENU** button back to the last menu or let the unit idle one minute to exit menu mode.

#### **Backlight Intensity**

To select **Backlight Intensity**, press the **ENTER** button to show the **BACKLIGHT INTENSITY** on the display. Use the **UP/DOWN** button to adjust the intensity from **1** (dark) to **10** (bright). Once selected, press the **ENTER** button to setup and store. Press the **MENU** button back to the last menu or let the unit idle one minute to exit menu mode.

#### **Temperature Unit**

To Select **Temperature Unit**, press the **ENTER** button to show the **TEMPERATURE UNIT** on the display. Use the **UP/DOWN** button to select **°C** or **°F**, press the **ENTER** button to store. Press the **MENU** button back to the last menu or let the unit idle one minute to exit menu mode.

#### **Display Warning**

To select **Display Warning**, press the **ENTER** button to show the **DISPLAY WARNING** on the display. Use the **UP/DOWN** button to select **No** (Normal) or **Yes** (display will show the error warning when the unit went wrong), press the **ENTER** button to store. Press the **MENU** button back to the last menu or let the unit idle one minute to exit menu mode.

### **Fixture Test**

Enter **MENU** mode, select **Fixture Test**, press the **ENTER** button to confirm, use the **UP/DOWN** button to select **Auto Test** or **Manual Test**

### **Auto Test**

To select **Auto Test**, press the **ENTER** button to show the **AUTO TEST** on the display. Press the **ENTER** button, the unit will run built-in programs to automatically test pan, tilt and zoom. Press the **MENU** button back to the last menu or exit menu mode after auto test.

### **Manual Test**

To select **Manual Test**, press the **ENTER** button to show the **MANUAL TEST** on the display. Press the **ENTER** button, and then use the **UP/DOWN** button to select channel, and adjust the channel value. Once selected, press the **ENTER** button to setup, the fixture will run as the channel value indicates. Press the **MENU** button back to the last menu or exit menu mode let the unit idle one minute.

(All channels value will become 0 after exiting **Manual Test** menu)

### **Fixture Information**

Enter **MENU** mode, select **Fixture Information**, press the **ENTER** button to confirm, use the **UP/DOWN** button to select **Fixture use time**, **Lamp On time** or **Firmware Version**.

### **Fixture use time**

To select **Fixture use time**, press the **ENTER** button to show the **FIXTURE USE TIME** on the display. Press the **ENTER** button, the fixture working hours will show on the display. Press the **MENU** button to exit.

### **Lamp On time**

To select **Lamp On time**, press the **ENTER** button to show the **LAMP ON TIME** on the display. Press the **ENTER** button to confirm, then use the **UP/DOWN** button to select **Exit** or **Reset Time**, press the **ENTER** button to store. Press the **MENU** button back to the last menu or exit menu mode let the unit idle one minute.

### **Firmware Version**

To select **Firmware Version**, press the **ENTER** button to show the **FIRMWARE VERSION** on the display. Press the **ENTER** button and the fixture software version will show on the display. Press the **MENU** button to exit.

### **Reset Functions**

Enter **MENU** mode, select **Reset Function**, press the **ENTER** button to confirm, use the **UP/DOWN** button to select **Pan/Tilt**, **Zoom** or **All**.

### **Pan/Tilt**

To Select **Pan/Tilt**, press the **ENTER** button to show the **PAN/TILT** on the display. Use the **UP/DOWN** button to select

**Yes** (the unit will run built-in program to reset pan and tilt to their home positions) or **No**, press the **ENTER** button to store. Press the **MENU** button to exit menu mode.

#### **Zoom**

To select **Zoom**, press the **ENTER** button to show the **ZOOM** on the display. Use the **UP/DOWN** button to select **Yes** (the unit will run built-in program to reset zoom to its home positions) or **No**, press the **ENTER** button to store. Press the **MENU** button to exit menu mode.

#### **All**

To select **All**, press the **ENTER** button to show the **ALL** on the display. Use the **UP/DOWN** button to select **Yes** (the unit will run built-in program to reset all motors to their home positions) or **No**, press **ENTER** button to store. Press **MENU** button to exit menu mode.

#### **Special Functions**

Enter **MENU** mode, select **Special Functions**, press the **ENTER** button to confirm, use the **UP/DOWN** button to select **Fixture Maintenance** or **Factory Setting**.

#### **Fixture Maintenance**

To select **Fixture Maintenance**, press the **ENTER** button to show the **FIXTURE MAINTENANCE** on the display. Use the **UP/DOWN** button to select **Interval** or **Remain Time**.

#### **Interval**

To select **Interval**, press the **ENTER** button to confirm, the interval time will be shown on the display. Press the **MENU** button to exit.

#### **Remain Time**

To select **Remain Time**, press the **ENTER** button to confirm, the remaining time will be shown on the display. Press the **ENTER** button to confirm, use the **UP/DOWN** button to select **Exit** or **Reset time**, press the **MENU** button to exit.

#### **Factory Setting**

To select **Factory Setting**, press the **ENTER** button to show the **FACTORY SETTING** on the display. Press the **ENTER** button to confirm, use the **UP/DOWN** button to select **No** or **Yes** (the fixture will reset to factory settings and exit menu mode).

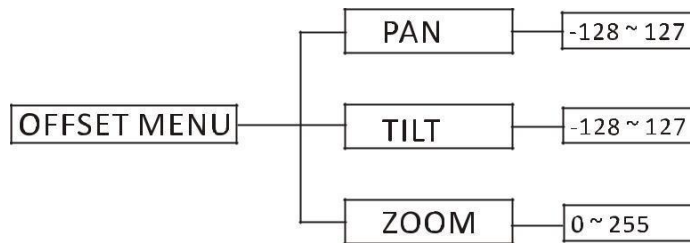

In the main functions, hold the **ENTER** button for at least 3 seconds into offset mode, use the **DOWN/UP** button up to select **Pan Offset**, **Tilt Offset** or **Zoom Offset**, and press the **ENTER** button to confirm. Use the **DOWN/UP** button to adjust the home position of the Pan, Tilt or Zoom, Once the position has been selected, press the **ENTER** button to setup, to go back to the functions without any change press the **MENU** button again. Press and hold the **MENU** button about one second or wait for about one minute to exit the menu mode.

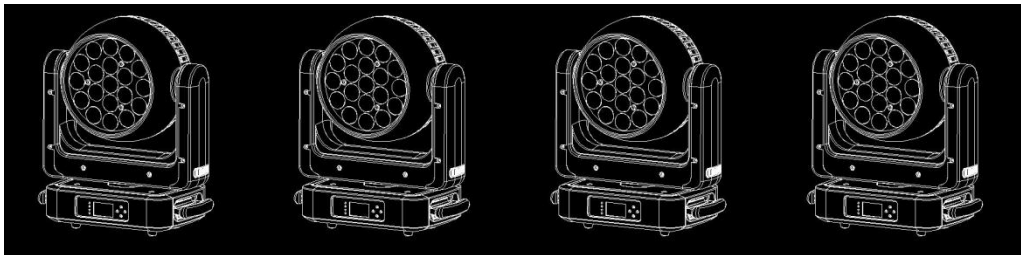

#### 4.1 DMX 512 connection

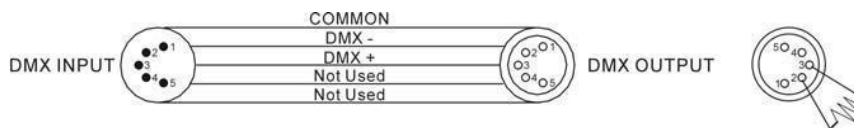

1. If you using a controller with 5 pins DMX output, you need to use a 5 to 3 pin adapter-cable.
2. The last units DMX cable has to be terminated with a 120 ohm 1/4W resistor between pin 2(DMX-) and pin 3(DMX+) of a 3-pin XLR-plug and plug it in the DMX-output of the last unit.
3. Connect the unit together in a `daisy chain` by XLR plug from the output of the unit to the input of the next unit. The cable can not branched or split to a `Y` cable. DMX 512 is a very high-speed signal. Inadequate or damaged cables,

soldered joints or corroded connectors can easily distort the signal and shut down the system.

4. The DMX output and input connectors are pass-through to maintain the DMX circuit, when one of the units' power is disconnected.
5. Each fixture unit needs to have an address set to receive the data sent by the controller. The address number is between 0-511 (usually 0 & 1 are equal to 1).
6. The end of the DMX 512 system should be terminated to reduce signal errors.
7. 3 pin XLR connectors are more popular than 5 pin XLR.  
 3 pin XLR: Pin 1: GND, Pin 2: Negative signal (-), Pin 3: Positive signal (+)  
 5 pin XLR: Pin 1: GND, Pin 2: Negative signal (-), Pin 3: Positive signal (+),  
 Pin 4/Pin 5: Not used.

## 4.2 Address Setting

If you use a universal DMX controller to control the units, you have to set DMX address from 1 to 512 so that the units can receive DMX signal. Press the **MENU** button to enter menu mode, select **DMX Functions**, press the **ENTER** button to confirm, use the **UP/DOWN** button to select **DMX Address**, press the **ENTER** button to confirm, the present address will blink on the display, use the **UP/DOWN** button to adjust the address from 001 to 512, and press the **ENTER** button to store. Press the **MENU** button back to the last menu or let the unit idle 7 seconds to exit menu mode.

Please refer to the following diagram to set the DMX address for the first 4 units:

Channel mode	Unit 1 Address	Unit 2 Address	Unit 3 Address	Unit 4 Address
14 channels	1	15	29	43
27 channels	1	27	53	79

## 4.3 DMX 512 Configuration

### 14 Channels Mode:

CHANNEL	VALUE	FUNCTION
1	000 - 019	<b>Beam electronic shutter effect</b>
	020 - 024	Shutter closed
	025 - 064	Shutter open
	065 - 069	Strobe 1 (fast - slow)
	070 - 084	Shutter open
	085 - 089	Strobe 2: opening pulse (fast - slow)
	090 - 104	Shutter open
		Strobe 3: closing pulse (fast - slow)

	105 - 109 110 - 124 125 - 129 130 - 144 145 - 149 150 - 164 165 - 169 170 - 184 185 - 189 190 - 204 205 - 209 210 - 224 225 - 229 230 - 244 245 - 255	Shutter open Strobe 4: random strobe (fast - slow) Shutter open Strobe 5: random opening pulse (fast - slow) Shutter open Strobe 6: random closing pulse (fast - slow) Shutter open Strobe 7: burst pulse (fast - slow) Shutter open Strobe 8: random burst pulse (fast - slow) Shutter open Strobe 9: sine wave (fast - slow) Shutter open Strobe 10: burst (fast - slow) Shutter open
2	000 - 255	<b>Beam dimmer</b> 0 - 100% intensity
3	000 - 255	<b>Zoom</b> Wide - narrow
4	000 - 255	<b>Pan</b> Pan 0° - 540°
5	000 - 255	<b>Pan fine</b> Pan fine adjustment (Least Significant Byte)
6	000 - 255	<b>Tilt</b> Tilt 0° - 240°
7	000 - 255	<b>Tilt fine</b> Tilt fine adjustment (Least Significant Byte)
8	000 - 009 010 - 014 015 - 039 040 - 044 045 - 049 050 - 054 055 - 059 060 - 064 065 - 069 070 - 074 075 - 089 090 - 094 095 - 099 100 - 104 105 - 109 110 - 114 115 - 119 120 - 124 125 - 249 250 - 255	<b>Fixture control settings</b> No function Reset entire fixture No function PTSP = NORM PTSP = FAST PTSP = SLOW No function Fan mode FULL2 No function Fan mode REGULATED2 No function Dimmer Curve Line Dimmer Curve Square Law Dimmer Curve Inverse Square Law Dimmer Curve S Fast dimming, speed of changes unrestricted No function Smooth dimming, speed of changes restricted slightly No function Illuminate display

9	000 - 009 010 - 014 015 - 019 020 - 024 025 - 029 030 - 034 035 - 039 040 - 044 045 - 049 050 - 054 055 - 059 060 - 064 065 - 069 070 - 074 075 - 079 080 - 084 085 - 089 090 - 094 095 - 099 100 - 104 105 - 109 110 - 114 115 - 119 120 - 124 125 - 129 130 - 134 135 - 139 140 - 144 145 - 149 150 - 154 155 - 159 160 - 164 165 - 169 170 - 174 175 - 179  180 - 201 202 - 207 208 - 229 230 - 234  235 - 239 240 - 244 245 - 249 250 - 255	<b>Beam color wheel effect</b> Open. RGBW color mixing enabled LEE 790 - Moroccan pink LEE 157 - Pink LEE 332 - Special rose pink LEE 328 - Follies pink LEE 345 - Fuchsia pink LEE 194 - Surprise pink LEE 181 - Congo Blue LEE 071 - Tokyo Blue LEE 120 - Deep Blue LEE 079 - Just Blue LEE 132 - Medium Blue LEE 200 - Double CT Blue LEE 161 - Slate Blue LEE 201 - Full CT Blue LEE 202 - Half CT Blue LEE 117-Steel Blue LEE 353 - Lighter Blue LEE 118 - Light Blue LEE 116 - Medium Blue Green LEE 124 - Dark Green LEE 139 - Primary Green LEE 089 - Moss Green LEE 122 - Fern Green LEE 738 - JAS Green LEE 088 - Lime Green LEE 100 - Spring Yellow LEE 104 - Deep Amber LEE 179 - Chrome Orange LEE 105 - Orange LEE 021 - Gold Amber LEE 778 - Millennium Gold LEE 135 - Deep Golden Amber LEE 164 - Flame Red Open <b>Color wheel rotation effect</b> Clockwise, fast - slow Stop (this will stop wherever the color is at the time) Counter-clockwise, slow - fast Open <b>Random color</b> Fast Medium Slow Open
10	000 - 255	<b>Beam red</b> Red 0- 100%
11		<b>Beam green</b>

	000 - 255	Green 0- 100%
12	000 - 255	<b>Beam blue</b> Blue 0- 100%
13	000 - 255	<b>Beam white</b> White 0- 100%
14	22-39 (2200K), 40-57 (2400K), 58-75 (2800K), 76-93 (3200k), 94-111 (3600k), 112-129 (4200K), 130-147 (4800K), 148-165 (5600K), 166-183 (6500k), 184-201 (7500K), 202-219 (8500k), 220-237 (9500K), 238-255 (10000K)	

## 27 Channels Mode

CHANNEL	VALUE	FUNCTION
1	000 - 255	<b>PAN</b>
2	000 - 255	<b>PAN FINE</b>
3	000 - 255	<b>TILT</b>
4	000 - 255	<b>TILT FINE</b>
5	000 - 255	<b>PAN/TILT SPEED</b> fast    slow
6		<b>ZOOM</b> wide    narrow
7	000 - 009 010 - 014 015 - 255	<b>SPECIAL FUNCTIONS</b> No function Reset No function
8	000 - 255	<b>DIMMER</b> 0%~100%
9	000 - 019 020 - 024 025 - 064 065 - 069 070 - 084 085 - 089 090 - 104 105 - 109 110 - 124 125 - 129 130 - 144 145 - 149 150 - 164 165 - 169 170 - 184 185 - 189 190 - 204	<b>SHUTTER</b> Blackout Open Strobe 1: fast    slow Open Strobe 2: opening pulse, fast    slow Open Strobe 3: closing pulse, fast    slow Open Strobe 4: random strobe, fast    slow Open Strobe 5: random opening pulse, fast    slow Open Strobe 6: random closing pulse, fast    slow Open Strobe 7: burst pulse, fast    slow Open Strobe 8: random burst pulse, fast    slow



	205 - 209	Open
	210 - 224	Strobe 9: sine wave, fast    slow
	225 - 229	Open
	230 - 244	Strobe 10: burst, fast    slow
	245 - 255	Open
10	000 - 255	<b>RING 1 RED (0- 100%)</b>
11	000 - 255	<b>RING 1 GREEN (0- 100%)</b>
12	000 - 255	<b>RING 1 BLUE (0- 100%)</b>
13	000 - 255	<b>RING 1 WHITE (0- 100%)</b>
14		<b>RING 1 COLOR PRESET</b>
	000 - 009	Open
	010 - 017	Color1
	018 - 024	Color2
	025 - 032	Color3
	033 - 039	Color4
	040 - 047	Color5
	048 - 054	Color6
	055 - 061	Color7
	062 - 069	Color8
	070 - 076	Color9
	077 - 084	Color10
	085 - 091	Color11
	092 - 099	Color12
	100 - 106	Color13
	107 - 113	Color14
	114 - 121	Color15
	122 - 128	Color16
	129 - 136	Color17
	137 - 143	Color18
	144 - 151	Color19
	152 - 158	Color20
	159 - 165	Color21
	166 - 173	Color22
	174 - 180	Color23
	181 - 188	Color24
	189 - 195	Color25
	196 - 203	Color26
	204 - 210	Color27
	211 - 217	Color28
	218 - 225	Color29
	226 - 232	2700K
Color Temperature	233 - 240	3200K
	241-247	4200K
	248-255	5600K
15	000 - 255	<b>RING 2 RED (0- 100%)</b>
16	000 - 255	<b>RING 2 GREEN (0- 100%)</b>

17	000 - 255	<b>RING 2 BLUE (0- 100%)</b>
18	000 - 255	<b>RING 2 WHITE (0- 100%)</b>
19	000 - 255	<b>RING 2 COLOR PRESET</b> (The same as CH14: RING 1 COLOR PRESET)
20	000 - 255	<b>RING 3 RED (0- 100%)</b>
21	000 - 255	<b>RING 3 GREEN (0- 100%)</b>
22	000 - 255	<b>RING 3 BLUE (0- 100%)</b>
23	000 - 255	<b>RING 3 WHITE (0- 100%)</b>
24	000 - 255	<b>RING 3 COLOR PRESET</b> (The same as CH14: RING 1 COLOR PRESET)
25	000-050 051-059 060-069 070-077 078-086 087-095 096-255	<b>RING COLOR MACRO</b> Blackout Macro1 Macro2 Macro3 Macro4 Macro5 Macro6
26	000 - 255	<b>COLOR MACRO SPEED</b> Slow fast
27	cto	22-39(2200K),40-57(2400K),58-75(2800K),76-93(3200k),94-111(3600k),112-129(4200K),130-147(4800K),148-165(5600K),166-183(6500k),184-201(7500K),202-219(8500k),220-237(9500K),238-255(10000K)

Following are a few common problems that may occur during operation. Here are some suggestions for easy troubleshooting:

**A. The unit does not work, no light and the fan does not work**

1. Check the connection of power and main fuse.
2. Measure the mains voltage on the main connector.
3. Check the power on LED.

**B. Not responding to DMX controller**

1. DMX LED should be on. If not, check DMX connectors and cables to see if link properly.
2. If the DMX LED is on and no response to the channel, check the address settings and DMX polarity.

3. If you have intermittent DMX signal problems, check the pins on connectors or on PCB of the unit or the previous one.
4. Try to use another DMX controller.
5. Check if the DMX cables run near or run alongside to high voltage cables that may cause damage or interference to DMX interface circuit.

**C. One of the channels is not working well**

1. The stepper motor might be damaged or the cable connected to the PCB is broken.
2. The motor's drive IC on the PCB might be out of condition.

**6. Fixture Cleaning**

The cleaning must be carried out periodically to optimize light output. Cleaning frequency depends on the environment in which the fixture operates: damp, smoky or particularly dirty surrounding can cause greater accumulation of dirt on the unit's optics.

- Clean with soft cloth using normal glass cleaning fluid.
- Always dry the parts carefully.
- Clean the external optics at least every 30 days.