



JOLT BAR FX

User Manual

©2023 ADJ Products, LLC all rights reserved. Information, specifications, diagrams, images, and instructions herein are subject to change without notice. ADJ Products, LLC logo and identifying product names and numbers herein are trademarks of ADJ Products, LLC. Copyright protection claimed includes all forms and matters of copyrightable materials and information now allowed by statutory or judicial law or hereinafter granted. Product names used in this document may be trademarks or registered trademarks of their respective companies and are hereby acknowledged. All non-ADJ Products, LLC brands and product names are trademarks or registered trademarks of their respective companies.

ADJ Products, LLC and all affiliated companies hereby disclaim any and all liabilities for property, equipment, building, and electrical damages, injuries to any persons, and direct or indirect economic loss associated with the use or reliance of any information contained within this document, and/or as a result of the improper, unsafe, insufficient and negligent assembly, installation, rigging, and operation of this product.

ADJ PRODUCTS LLC World Headquarters

6122 S. Eastern Ave. | Los Angeles, CA 90040 USA

Tel: 800-322-6337 | Fax: 323-582-2941 | www.adj.com | lsupport@adj.com

ADJ Supply Europe B.V.

Junostraat 2 | 6468 EW Kerkrade | Netherlands

Tel: +31 45 546 85 00 | Fax: +31 45 546 85 99 | www.americandj.eu | service@americandj.eu

Europe Energy Saving Notice

Energy Saving Matters (EuP 2009/125/EC)

Saving electric energy is a key to help protecting the environment. Please turn off all electrical products when they are not in use. To avoid power consumption in idle mode, disconnect all electrical equipment from power when not in use. Thank you!

DOCUMENT VERSION



Due to additional product features and/or enhancements, an updated version of this document may be available online. Please check www.adj.com for the latest revision/update of this manual before beginning installation and/or programming.

Date	Document Version	Software Version	DMX Channels	Notes
01/24/2022	1.0	1.0	6/9/13/16/18/32/38/ 42/64/112/126	Initial Release
03/04/2022	1.1	1.0	6/9/13/16/18/32/38/ 43/64/112/127	Corrected System Menu, DMX Traits, and Specifications
10/20/2022	1.2	1.0	No Change	Updated Dimensions
11/28/2022	1.3	N/C	No Change	Added FCC, Updated Power Consumption
12/29/2022	1.4	1.2	6/9/13/16/18/32/32A/ 38/43/64/112/127	Updated System Menu, DMX Traits, Specifications
02/03/2023	1.5	N/C	No Change	Corrected LED Pixel Zones; updated RDM
05/19/2023	1.6	N/C	No Change	Updated Safety Guidelines, Overview, Installation, Daisy Chain Power Linking, LED Pixel Zones, Specifications; added Color Macros Chart
06/16/2023	1.7	1.3	6/9/13/16/18/32/32A/ 38/43/64/78/112/127	Updated System Menu, DMX Setup, DMX Traits, LED Pixel Zones, Specifications
07/14/2023	1.8	N/C	No Change	Updated RDM, System Menu, Specifications

CONTENTS

Introduction	4
Limited Warranty (USA Only)	5
Warranty Registration Features	6
Safety Guidelines	7
Overview	8
Installation	9
Remove Device Management	12
Control Panel	13
System Menu	14
DMX Setup	17
DMX Traits	19
LED Pixel Zones	25
Color Macro Chart	26
Dimmer Modes and Curves	27
Daisy Chain Power Linking Cleaning and Maintenance	28
Dimensional Drawings	29
Specifications	30
FCC Statement	31

GENERAL INFORMATION

INTRODUCTION

Please read and understand the instructions in this manual carefully and thoroughly before attempting to operate this device. These instructions contain important safety and use information.

This product is intended for use by professionally trained personnel only, and is not suitable for private use.

UNPACKING

Every device has been thoroughly tested and has been shipped in perfect operating condition. Carefully check the shipping carton for damage that may have occurred during shipping. If the carton is damaged, carefully inspect the device for damage, and be sure all accessories necessary to install and operate the device have arrived intact. In the event damage has been found or parts are missing, please contact our customer support team for further instructions. Please do not return this device to your dealer without first contacting customer support. Please do not discard the shipping carton in the trash. Please recycle whenever possible.

BOX CONTENTS

Omega Brackets
1.83M locking power cable

CUSTOMER SUPPORT

Contact ADJ Service for any product related service and support needs.
Also visit forums.adj.com with questions, comments or suggestions.

ADJ SERVICE USA - Monday - Friday 8:00am to 4:30pm PST
323-582-2650 | Fax: 323-832-2941 | support@adj.com

ADJ SERVICE EUROPE - Monday - Friday 08:30 to 17:00 CET
+31 45 546 85 60 | Fax: +31 45 546 85 96 | support@adj.eu

REPLACEMENT PARTS please visit parts.adj.com



IMPORTANT NOTICE!

**THERE ARE NO USER SERVICEABLE PARTS INSIDE THIS UNIT.
DO NOT ATTEMPT ANY REPAIRS YOURSELF; DOING SO WILL VOID YOUR MANUFACTURER'S WARRANTY. DAMAGES RESULTING FROM MODIFICATIONS TO THIS FIXTURE AND/OR THE DISREGARD OF SAFETY INSTRUCTIONS AND GUIDELINES IN THIS MANUAL VOID THE MANUFACTURER'S WARRANTY AND ARE NOT SUBJECT TO WARRANTY CLAIMS AND/OR REPAIRS.**

LIMITED WARRANTY (USA ONLY)

- A. ADJ Products, LLC hereby warrants, to the original purchaser, ADJ Products, LLC products to be free of manufacturing defects in material and workmanship for a prescribed period from the date of purchase (see specific warranty period on reverse). This warranty shall be valid only if the product is purchased within the United States of America, including possessions and territories. It is the owner's responsibility to establish the date and place of purchase by acceptable evidence, at the time service is sought.
- B. For warranty service, you must obtain a Return Authorization number (RA#) before sending back the product-please contact ADJ Products, LLC Service Department at 800-322-6337. Send the product only to the ADJ Products, LLC factory. All shipping charges must be pre-paid. If the requested repairs or service (including parts replacement) are within the terms of this warranty, ADJ Products, LLC will pay return shipping charges only to a designated point within the United States. If the entire instrument is sent, it must be shipped in its original package. No accessories should be shipped with the product. If any accessories are shipped with the product, ADJ Products, LLC shall have no liability whatsoever for loss of or damage to any such accessories, or for the safe return thereof.
- C. This warranty is void if the serial number has been altered or removed; if the product is modified in any manner which ADJ Products, LLC concludes, after inspection, affects the reliability of the product, if the product has been repaired or service by anyone other than ADJ Products, LLC factory unless prior written authorization was issued to purchaser by ADJ Products, LLC; if the product is damaged because not properly maintained as set forth in the instruction manual.
- D. This is not a service contract, and this warranty does not include maintenance, cleaning or periodic check up. During the period specified above, ADJ Products, LLC will replace defective parts at its expense with new or refurbished parts, and will absorb all expenses for warranty service and repair labor by reason of defects in material or workmanship. The sole responsibility of ADJ Products, LLC under this warranty shall be limited to the repair of the product, or replacement thereof, including parts, at the sole discretion of ADJ Products, LLC. All products covered by this warranty were manufactured after August 15, 2012, and bear identifying marks to that effect.
- E. ADJ Products, LLC reserves the right to make changes in design and/or improvements upon its products without any obligation to include these changes in any products theretofore manufactured.
- F. No warranty, whether expressed or implied, is given or made with respect to any accessory supplied with products described above. Except to the extent prohibited by applicable law, all implied warranties made by ADJ Products, LLC in connection with this product, including warranties of merchantability or fitness, are limited in duration to the warranty period set forth above. And no warranties, whether expressed or implied, including warranties of merchantability or fitness, shall apply to this product after said period has expired. The consumer's and/or Dealer's sole remedy shall be such repair or replacement as is expressly provided above; and under no circumstances shall ADJ Products, LLC be liable for any loss or damage, direct or consequential, arising out of the use of, or inability to use, this product.
- G. This warranty is the only written warranty applicable to ADJ Products, LLC Products and supersedes all prior warranties and written descriptions of warranty terms and conditions heretofore published.

LIMITED WARRANTY PERIODS

- **Non L.E.D. Lighting Products = 1-year (365 days) Limited Warranty** (Such as: Special Effect Lighting, Intelligent Lighting, UV lighting, Strobes, Fog Machines, Bubble Machines, Mirror Balls, Par Cans, Trussing, Lighting Stands etc. excluding LED and lamps)
- **Laser Products = 1 Year (365 Days) Limited Warranty** (excludes laser diodes which have 6 month limited warranty)
- **L.E.D. Products = 2-year (730 days) Limited Warranty** (excluding batteries which have a 180 day limited warranty)
Note: 2 Year Warranty only applies to purchases within the United States.
- **StarTec Series = 1 Year Limited Warranty** (excluding batteries which have a 180 day limited warranty)
- **ADJ DMX Controllers = 2 Year (730 Days) Limited Warranty**

WARRANTY REGISTRATION

The Jolt Bar FX carries a 2 year limited warranty. Please fill out the enclosed warranty card to validate your purchase. All returned service items, whether under warranty or not, must be freight pre-paid and accompanied by a return authorization (R.A.) number. The R.A. number must be clearly written on the outside of the return package. A brief description of the problem as well as the R.A. number must also be written down on a piece of paper included in the shipping carton. If the unit is under warranty, you must provide a copy of your proof of purchase invoice. You may obtain an R.A. number by contacting our customer support team on our customer support number. All packages returned to the service department not displaying an R.A. number on the outside of the package will be returned to the shipper.

FEATURES

The ADJ Jolt Bar FX is a professional linear LED fixture that delivers lighting designers huge output as well as the creative potential of brilliant bright white strobe/blinder LEDs combined with multi-colored chase effects in one versatile unit. Ideal for concert productions, festival stages and rental houses, as well as for permanent installation in large nightclubs, the Jolt Bar FX is a flexible fixture that can be used to create a wide variety of effects.

- 32 x RGB LED zones with individual control
- 16 X Cool White LED zones with individual control
- Color mixing effect
- Strobe effect with variable speed
- Smooth dimming from 0% to 100%
- Double mounting brackets with 180-degree adjustability

INCLUDED ITEMS:

- 1 x Locking power cable

IP RATING

This device is IP20 rated. This means that the unit is protected against the intrusions of solids approximately the size of an adult finger (2.5mm) or larger, but **the unit is not protected against water or liquid intrusion of any kind.**

SAFETY GUIDELINES

THIS FIXTURE IS COMPOSED OF SOPHISTICATED ELECTRONIC COMPONENTS. TO GUARANTEE SMOOTH OPERATION, IT IS IMPORTANT TO FOLLOW ALL INSTRUCTIONS AND GUIDELINES IN THIS MANUAL. ADJ PRODUCTS, LLC IS NOT RESPONSIBLE FOR INJURY AND/OR DAMAGES RESULTING FROM THE MISUSE OF THIS FIXTURE DUE TO THE DISREGARD OF THE INFORMATION PRINTED IN THIS MANUAL. ONLY QUALIFIED AND/OR CERTIFIED PERSONNEL SHOULD PERFORM INSTALLATION OF THIS FIXTURE AND ONLY THE ORIGINAL RIGGING PARTS INCLUDED WITH THIS FIXTURE SHOULD BE USED FOR INSTALLATION. ANY MODIFICATIONS TO THE FIXTURE AND/OR THE INCLUDED MOUNTING HARDWARE WILL VOID THE ORIGINAL MANUFACTURER'S WARRANTY AND INCREASE THE RISK OF DAMAGE AND/OR PERSONAL INJURY. ONLY CERTIFIED PERSONNEL SHOULD PERFORM INSTALLATION OF THIS FIXTURE.

- PROTECTION CLASS 1 - FIXTURE MUST BE PROPERLY GROUNDED.
- THERE ARE NO USER SERVICEABLE PARTS INSIDE THIS UNIT.
- DO NOT ATTEMPT ANY REPAIRS YOURSELF; DOING SO WILL VOID YOUR MANUFACTURER'S WARRANTY. DAMAGES RESULTING FROM MODIFICATIONS TO THIS FIXTURE AND/OR THE DISREGARD OF SAFETY INSTRUCTIONS AND GUIDELINES IN THIS MANUAL VOID THE MANUFACTURER'S WARRANTY AND ARE NOT SUBJECT TO ANY WARRANTY CLAIMS AND/OR REPAIRS.
- DO NOT PLUG FIXTURE INTO A DIMMER PACK!
- NEVER OPEN THIS FIXTURE WHILE IN USE!
- UNPLUG POWER BEFORE SERVICING FIXTURE!
- NEVER TOUCH FIXTURE DURING OPERATION, AS IT MAY BE HOT!
- KEEP FLAMMABLE MATERIALS AWAY FROM FIXTURE!
- NEVER LOOK DIRECTLY INTO THE LIGHT SOURCE!
- RETINA INJURY RISK - MAY INDUCE BLINDNESS!
- SENSITIVE PERSONS MAY SUFFER AN EPILEPTIC SHOCK!
- INDOOR / DRY LOCATIONS USE ONLY!
- DO NOT EXPOSE FIXTURE TO RAIN AND MOISTURE!
- MINIMUM DISTANCE TO OBJECTS/SURFACES IS 1.6 FEET (0.5 METERS)
- MINIMUM DISTANCE TO FLAMMABLE MATERIALS FROM THE SURFACE IS 8.5 INCHES (22 CM).
- DO NOT TOUCH the fixture housing during operation. Turn OFF the power and allow approximately 15 minutes for the fixture to cool down before serving.
- DO NOT shake fixture, and avoid brute force when installing and/or operating fixture.
- DO NOT operate fixture if the power cord is frayed, crimped, damaged and/or if any of the power cord connectors are damaged and do not insert into the fixture securely with ease. NEVER force a power cord connector into the fixture. If the power cord or any of its connectors are damaged, replace it immediately with a new one of the same power rating.
- DO NOT block any air ventilation slots. All fan and air inlets must remain clean and never blocked. Allow approx. 20" (15cm) between fixture and other devices or a wall for proper cooling.
- When installing fixture in a suspended environment, always use mounting hardware that is no less than M10 x 25 mm, and always install fixture with an appropriately rated safety cable.
- Always disconnect fixture from main power source before performing any type of service and/or cleaning procedure.
- Only handle the power cord by the plug end. Never pull out the plug by tugging the wire portion of the cord.
- During the initial operation of this fixture, a light smoke or smell may emit from the interior of the fixture. This is a normal process and is caused by excess paint in the interior of the casing burning off from the heat associated with the lamp and will decrease gradually over time.
- Consistent operational breaks will ensure fixture will function properly for many years.
- Only use original packaging and materials to transport the fixture in for service.

OVERVIEW

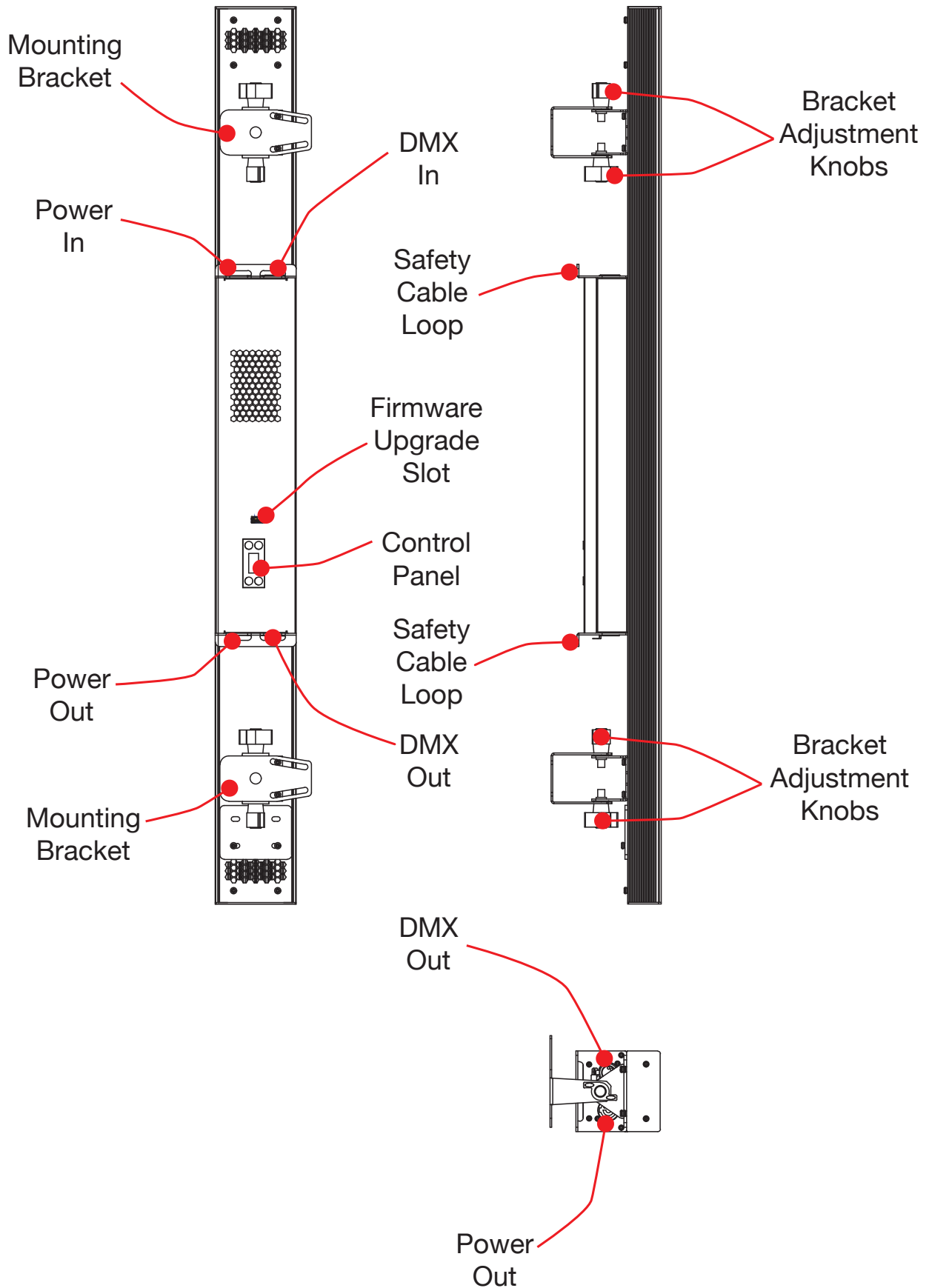

INSTALLATION



FLAMMABLE MATERIAL WARNING

Keep fixture minimum 8.5 in. (22cm) away from flammable materials and/or pyrotechnics.



ELECTRICAL CONNECTIONS

A qualified electrician should be used for all electrical connections and/or installations.



MINIMUM DISTANCE TO OBJECTS/SURFACES IS 1.6 FEET (0.5 METERS).

MINIMUM DISTANCE OF INFLAMMABLE MATERIALS FROM THE SURFACE IS 8.5 IN. (22 CM).

DO NOT INSTALL THE FIXTURE IF YOU ARE NOT QUALIFIED TO DO SO!

- Fixture **MUST** be installed following all local, national, and country commercial electrical and construction codes and regulations.
- Before rigging/mounting a single fixture or multiple fixtures to any metal truss/structure or placing the fixture(s) on any surface, a professional equipment installer **MUST** be consulted to determine if the metal truss/structure or surface is properly certified to safely hold the combined weight of the fixture(s), clamps, cables, and accessories.
- Maximum ambient operating temperature is **104°F (40°C)**. Do not use fixture when ambient temperature exceeds this value.
- Fixture(s) should be installed outside walking paths, seating areas, or areas where unauthorized personnel might reach the fixture by hand.
- **NEVER** stand directly below the fixture(s) when rigging, removing, or servicing.
- Overhead fixture installation must always be secured with a secondary safety attachment, such as an appropriately rated safety cable.
- Allow approximately 15 minutes for the fixture to cool down before servicing.

IP RATING

This device is IP20 rated. This means that the unit is protected against the intrusion of solids 2.5mm in size or larger (approximately the size of an adult finger tip). The unit is NOT protected against water or liquid intrusion of any kind!

RIGGING

Overhead rigging requires extensive experience, including calculating working load limits, knowledge of installation material being used, and periodic safety inspection of all installation material and the fixture, among other skills. If you lack these qualifications, do not attempt the installation yourself. Improper installation can result in bodily injury.

INSTALLATION

CLAMP INSTALLATION

This fixture features a mounting point on the yoke for the attachment of a mounting clamp. There is also a safety cable loop located on the rear of the fixture (see the illustration below). When mounting the fixture to a truss or any other suspended or overhead installation, be sure to secure appropriately rated clamps (not included) to the yoke, and attach a separate SAFETY CABLE of the appropriate weight rating to the safety cable loop.

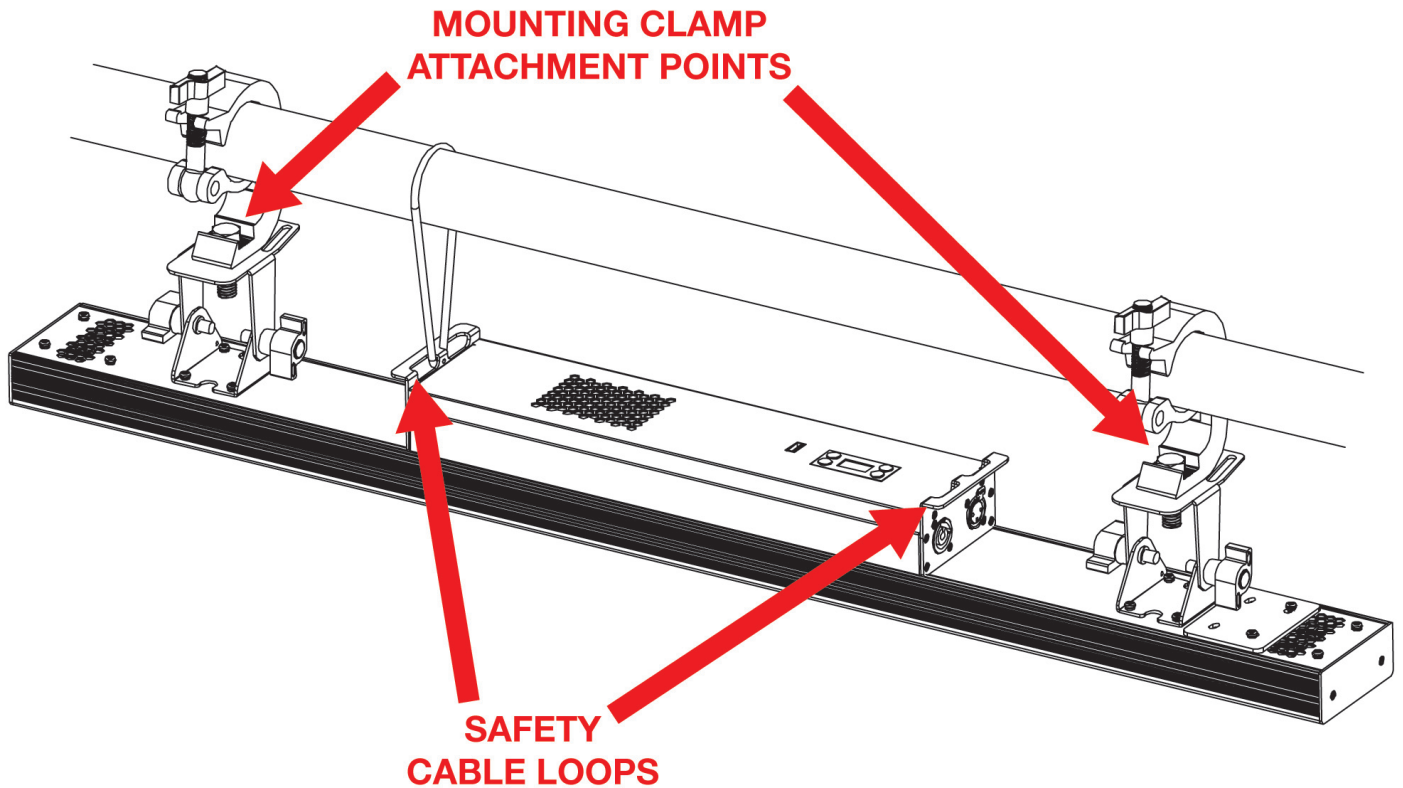

SAFETY CABLE:

ALWAYS ATTACH A SAFETY CABLE WHENEVER INSTALLING THIS FIXTURE IN A SUSPENDED ENVIRONMENT TO ENSURE THAT THE FIXTURE WILL NOT FALL IF THE CLAMPS FAIL.

INSTALLATION

CONNECTOR PLATE:

Each unit includes a connector plate that can be used to secure two adjacent mounted units together. To install the connector plate, follow the directions below:

1. Locate the connector plate. It is affixed to back of the unit, near one of the ends of the bar. See the illustrations below for guidance.

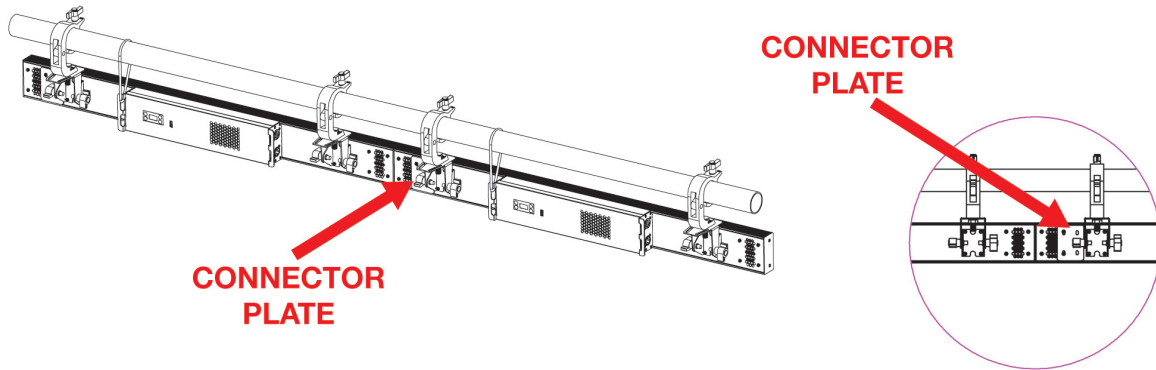

2. Remove the two (2) screws holding the connector plate in place, as well as two (2) screws on the end of each adjacent unit, for a total of six (6) screws. Remove the connector plate.

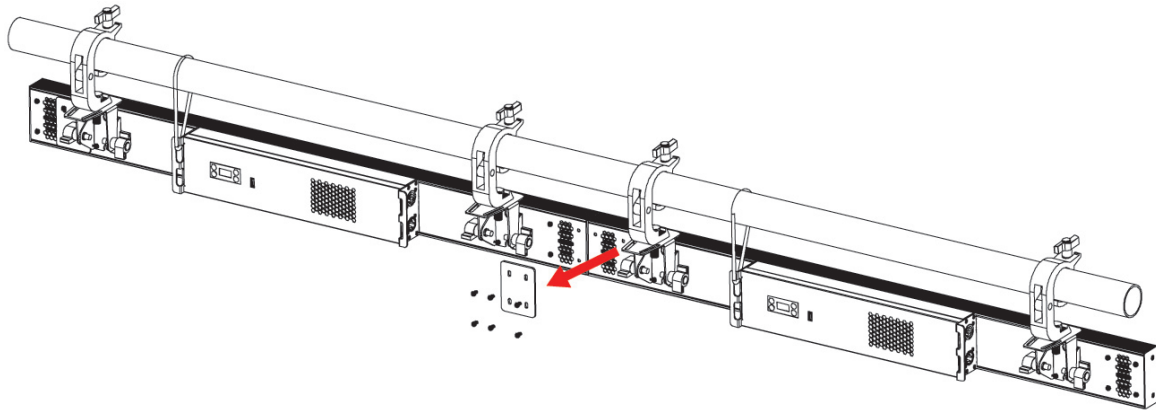

3. Place the connector plate across the gap between the two units, making sure to align the plate with the four (4) screw holes. Reinstall the four (4) screws that secure the connector plate in place, as well as the two (2) additional screws that held the connector plate in its storage position. The installation is now complete.

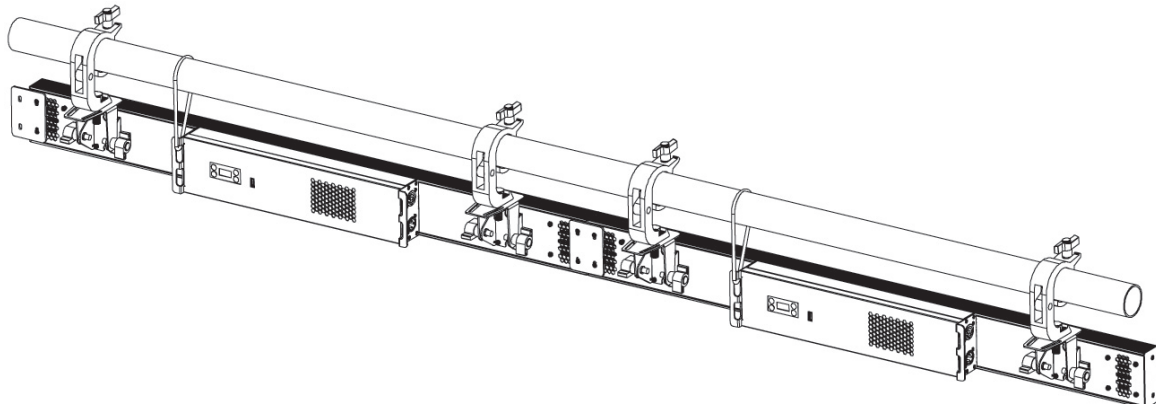

REMOTE DEVICE MANAGEMENT

NOTE: In order for RDM to work properly, RDM enabled equipment must be used throughout the entire system, including DMX data splitters and wireless systems.

Remote Device Management (RDM) is a protocol that sits on top of the DMX512 data standard for lighting, and allows the DMX systems of the fixtures to be modified and monitored remotely. This protocol is ideal for instances in which a unit is installed in a location that is not easily accessible.

With RDM, the DMX512 system becomes bi-directional, allowing a compatible RDM enabled controller to send out a signal to devices on the wire, as well as allowing the fixture to respond (known as a GET command). The controller can then use its SET command to modify settings that would typically have to be changed or viewed directly via the unit's display screen, including the DMX Address, DMX Channel Mode, and Temperature Sensors.

RDM FIXTURE INFORMATION:

RDM Code	Device ID	Device Model ID	Personality ID
0x1900	Random	0x1FDC	0x010A (6CH), 0x020A (9CH), 0x030A (13CH), 0x040A (16CH), 0x050A (18CH), 0x060A (32CH), 0x070A (32ACH), 0x080A (38CH) 0x090A (43CH), 0x0A0A (64CH), 0x0B0A (78CH), 0x0C0A (112CH), 0x0D0A (127CH)

Please be aware that not all RDM devices support all RDM features, and therefore it is important to check beforehand to ensure that the equipment that you are considering includes all of the features that you require.

[0x0200] Sensor Definition
[0x0201] Sensor Value
[0x0080] Device Model Description
[0x0081] Manufacturer Label
[0x0082] Device Label
[0x00E0] DMX Personality
[0x00E1] DMX Personality Description
[0x0400] Device Hours

CONTROL PANEL

The fixture includes an easy to navigate system menu control panel display where all necessary settings and adjustments are made.

- **MENU:** Leave current menu and return to previous menu level.
- **UP:** Scroll up in currently displayed menu.
- **DOWN:** Scroll down in currently displayed menu.
- **ENTER:** Select an option or confirm a selection.

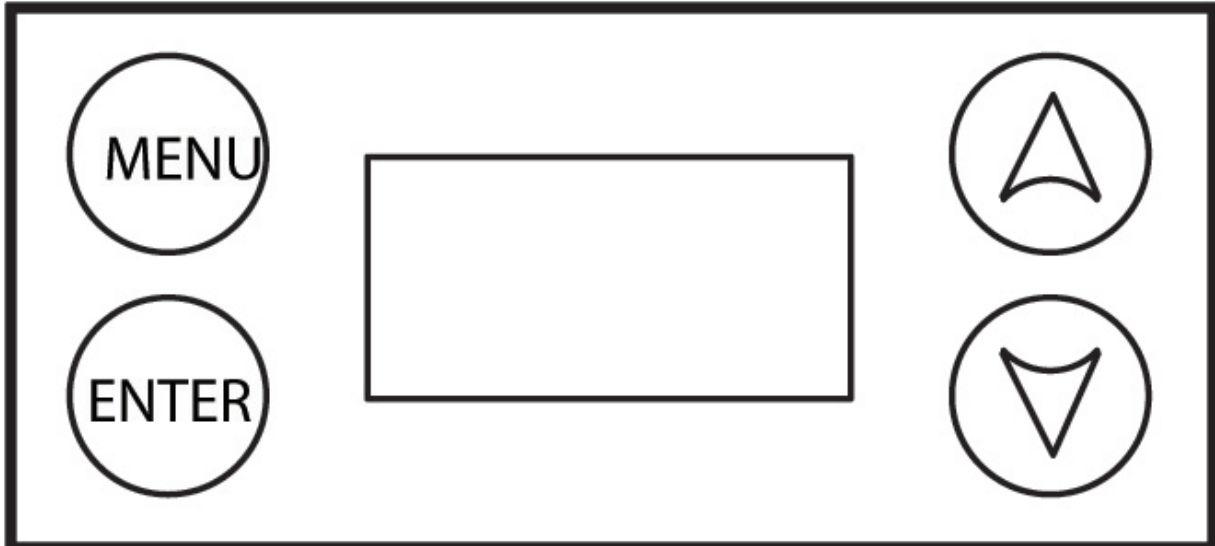

This fixture includes a display lock feature which automatically shuts off the display screen after a certain period of inactivity. This feature is OFF by default, which means that the display will always remain on regardless of inactivity, but can be configured to kick in after up to 10 minutes of inactivity. See the **System Menu** section of this manual for details on how to configure this setting.

SYSTEM MENU

DMX SETTINGS	DMX Address	1 - 507 (6ch)	Set DMX starting address, default = 1
		1 - 504 (9ch)	
		1 - 500 (13ch)	
		1 - 497 (16ch)	
		1 - 495 (18ch)	
		1 - 481 (32ch)	
		1 - 481 (32Ach)	
		1 - 475 (38ch)	
		1 - 470 (43ch)	
		1 - 449 (64ch)	
		1 - 435 (78ch)	
		1 - 401 (112ch)	
	1 - 386 (127ch)		
	DMX Ch Mode	6CH	Select DMX channel mode
		9CH	
13CH			
16CH			
18CH			
32CH			
32Ach			
38CH			
43CH			
64CH			
78Ch			
112CH			
127CH			
No DMX Status	Blackout	Takes all traits to 0 when DMX signal is lost or interrupted.	
	Hold	Holds all traits at last received value when DMX signal is lost or interrupted.	
	Manual	Defaults to values set in Manual Mode when DMX signal is lost or interrupted.	

CONTINUED ON NEXT PAGE

SYSTEM MENU

PERSONALITY	Dim Modes	Standard		Select dim mode	
		Stage			
		TV			
		Architectural			
		Theatre			
	Dimmer Curve	Stage 2		Select dimmer curve	
		Linear			
		Square			
		Inv. Square			
	Display	S-Curve		Turn backlight off after selected period of inactivity	
		Display Backlight	Off - 2 minutes		Lock screen after selected period of inactivity
		Display Lock	Off - 10 minutes		Invert screen display
	Temperature Unit	Display Invert		No / Yes	
		°C / °F		Select temperature display units	
	Fan Speed	Low		Set fan speed	
High					
Auto					
Service (Passcode = 011)	White Balance	Red1 (000 - 255)		Configure white balance. Zone 1 = upper outer section, zone 2 = lower outer section	
		Green1 (000 - 255)			
		Blue1 (000 - 255)			
		Red2 (000 - 255)			
		Green2 (000 - 255)			
	Blue2 (000 - 255)				
	USB Port Power	On / Off		Enable or disable power to service port	
	Update Software	Yes / No		Update unit software	
Factory Restore	Yes / No		Restore unit to factory default		
MANUAL	Red	000 - 255		Note: Manual control settings shall always hold when no DMX signal is detected	
	Green	000 - 255			
	Blue	000 - 255			
	White	000 - 255			
	Dimmer	000 - 255			
	Dimmer Fine	000 - 255			
	Strobe Effect	000 - 255			
	Strobe Rate	000 - 255			
	Strobe Duration	000 - 255			
FIXTURE TEST	Auto Test		Run fixture test		

CONTINUED ON NEXT PAGE

SYSTEM MENU

FIXTURE INFORMATION	Fixture Use Hour		Lifetime hours fixture has operated	
	LED Use Hour	Total LED Hour		Total hours since LED last replaced
		LED On Hour		Hours LED has been powered on since last replaced
		LED Hours Reset	No / Yes	Reset LED hours, Passcode = 011
	Temperature			Current fixture temperature
	Fan State			Current fan state
	RDM UID	xxxxxx		RDM UID
	Error Logs	Fixture Errors		List errors one by one
		Reset Error Log	No / Yes	(Passcode = 011)
	Firmware Version	x.xx		Current software version

DMX SETUP

DMX-512: DMX is short for Digital Multiplex. This is a universal protocol used as a form of communication between intelligent fixtures and controllers. A DMX controller sends DMX data instructions from the controller to the fixture. DMX data is sent as serial data that travels from fixture to fixture via the DATA “IN” and DATA “OUT” XLR terminals located on all DMX fixtures (most controllers only have a DATA “OUT” terminal).

DMX Linking: DMX is a language allowing all makes and models of different manufacturers to be linked together and operate from a single controller, as long as all fixtures and the controller are DMX compliant. To ensure proper DMX data transmission, try to use the shortest cable path possible when using several DMX fixtures. The order in which fixtures are connected in a DMX line does not influence the DMX addressing. For example, a fixture assigned a DMX address of 1 may be placed anywhere in a DMX line: at the beginning, at the end, or anywhere in the middle. When a fixture is assigned a DMX address of 1, the DMX controller knows to send DATA assigned to address 1 to that unit, no matter where it is located in the DMX chain.

Data Cable (DMX Cable) Requirements (For DMX Operation):The Jolt Panel FX can be controlled via DMX-512 protocol, and features multiple DMX channel modes. Your unit and your DMX controller require a 5-pin XLR connector for data input and data output. If you are making your own cables, be sure to use standard 110-120 Ohm shielded cable (This cable may be purchased at almost all pro lighting stores). Your cables should be made with a male XLR connector at one end and a female XLR connector on the other. Also remember that DMX cable must be daisy chained and cannot be split.

Special Note: Line Termination. When longer runs of cable are used, you may need to use a terminator on the last unit to avoid erratic behavior. A terminator is a 110-120 ohm 1/4 watt resistor which is connected between pins 2 and 3 of a male XLR connector (DATA + and DATA -). This unit is inserted in the female XLR connector of the last unit in your daisy chain to terminate the line. Using a cable terminator (ADJ part number Z-DMX/T) will decrease the chances of erratic behavior.

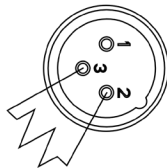
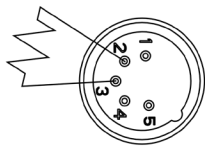

A DMX512 terminator reduces signal errors, avoiding most signal reflection interference. Connect PIN 2 (DMX-) and PIN 3 (DMX+) of the last fixture in series with a 120 Ohm, 1/4 W Resistor to terminate the DMX512.

DMX SETUP

DMX ADDRESSING

All fixtures should be given a DMX starting address when operating with a DMX controller, in order to ensure that the correct fixture responds to the correct control signal. This digital starting address is the channel number from which the fixture starts to “listen” to the digital control signal sent out from the DMX controller. The assignment of this starting DMX address is achieved by setting the correct DMX address on the digital control display on the fixture.

You can set the same starting address for all fixtures or a group of fixtures, or set different addresses for each individual fixture. Setting all fixtures to the same DMX address will cause all fixtures to react in the same way. In this case, please note that changing the settings of one channel will affect all the fixtures simultaneously.

If you set each fixture to a different DMX address, each unit will “listen” starting at the channel number you have set, based on the quantity of DMX channels of each fixture. That means changing the settings of one channel will only affect the selected fixture.

As an example, when operating this device in 6 channel mode, you should set the starting DMX address of the first unit to 1, the second unit to 7 (1 + 6), the third unit to 13 (1 + 6 + 6), and so on. (See the chart below for more details.)

Channel Mode	Unit 1 Address	Unit 2 Address	Unit 3 Address	Unit 4 Address
6 Channels	1	7	13	19
9 Channels	1	10	19	28
13 Channels	1	14	27	40
16 Channels	1	17	33	49
18 Channels	1	19	37	55
32 / 32A Channels	1	33	65	97
38 Channels	1	39	77	115
43 Channels	1	44	87	130
64 Channels	1	65	129	193
78 Channels	1	79	157	235
112 Channels	1	113	225	337
127 Channels	1	128	255	382

DMX TRAITS

CHANNEL													DMX VALUES	FUNCTION
6 CH	9 CH	13 CH	16 CH	18 CH	32 CH	32A CH	38 CH	43 CH	64 CH	78 CH	112 CH	127 CH		
1	1	1		1									000 - 255	Outer Red , 0% to 100%
2	2	2		2									000 - 255	Outer Green , 0% to 100%
3	3	3		3									000 - 255	Outer Blue , 0% to 100%
4	4	4											000 - 255	Inner White , 0% to 100%
							30	33		70			000 - 255	Inner White Group 1
							31	34		71			000 - 255	Inner White Group 2
							32	35		72			000 - 255	Inner White Group 3
							33	36		73			000 - 255	Inner White Group 4
5	5	6											000 - 255	Dimmer , 0% to 100%
6	6	7											000 - 255	Dimmer Fine , 0% to 100%
				5			25	26		65		98	000 - 255	Outer Dimmer , 0% to 100%
				6			26	27		66		99	000 - 255	Outer Dimmer Fine , 0% to 100%
														Strobe Effect
													000 - 002	Open
													003 - 005	Strobe
													006 - 050	Ramp up
													051 - 100	Ramp down
													101 - 150	Ramp up-down
													151 - 200	Lightning
													201 - 255	Random
	8	9											000 - 255	Strobe Rate , slow to fast
	9	10											000 - 255	Strobe Duration , slow to fast
		5		4				25				97	000 - 255	Outer Color Macros
														Outer Strobe Effect
													000 - 002	Open
													003 - 005	Strobe
				7			27	28		67		100	006 - 050	Ramp up
													051 - 100	Ramp down
													101 - 150	Ramp up-down
													151 - 200	Lightning
													201 - 255	Random
				8			28	29		68		101	000 - 255	Outer Strobe Rate , slow to fast
				9			29	30		69		102	000 - 255	Outer Strobe Duration , slow to fast

CONTINUED ON NEXT PAGE

DMX TRAITS

CHANNEL													DMX VALUES	FUNCTION	
6 CH	9 CH	13 CH	16 CH	18 CH	32 CH	32A CH	38 CH	43 CH	64 CH	78 CH	112 CH	127 CH			
				14			36	39		76			123		Inner Strobe Effect
														000 - 002	Open
														003 - 005	Strobe
														006 - 050	Ramp up
														051 - 100	Ramp down
														101 - 150	Ramp up-down
														151 - 200	Lightning
														201 - 255	Random
				15			37	40		77			124	000 - 255	Inner Strobe Rate , slow to fast
				16			38	41		78			125	000 - 255	Inner Strobe Duration , slow to fast
															Inner Program Macro
														000 - 005	No function
														006 - 033	Macro1
														034 - 060	Macro2
														061 - 088	Macro3
														089 - 116	Macro4
														117 - 144	Macro5
														145 - 172	Macro6
														173 - 200	Macro7
														201 - 228	Macro8
														229 - 255	Macro9
				18				43					127	000 - 255	Inner Program Macro Speed
		13												000 - 255	In/Out Program Macro Speed , slow to fast
			1		1	1	1	1	1	1	1	1	1	000 - 255	Red 1
			2		2	2	2	2	2	2	2	2	2	000 - 255	Green 1
			3		3	3	3	3	3	3	3	3	3	000 - 255	Blue 1
			4		4	4	4	4	4	4	4	4	4	000 - 255	Red 2
			5		5	5	5	5	5	5	5	5	5	000 - 255	Green 2
			6		6	6	6	6	6	6	6	6	6	000 - 255	Blue 2
			7		7	7	7	7	7	7	7	7	7	000 - 255	Red 3
			8		8	8	8	8	8	8	8	8	8	000 - 255	Green 3
			9		9	9	9	9	9	9	9	9	9	000 - 255	Blue 3
			10		10	10	10	10	10	10	10	10	10	000 - 255	Red 4
			11		11	11	11	11	11	11	11	11	11	000 - 255	Green 4

CONTINUED ON NEXT PAGE

DMX TRAITS

CHANNEL													DMX VALUES	FUNCTION
6 CH	9 CH	13 CH	16 CH	18 CH	32 CH	32A CH	38 CH	43 CH	64 CH	78 CH	112 CH	127 CH		
			12		12	12	12	12	12	12	12	12	000 - 255	Blue 4
					13	13	13	13	13	13	13	13	000 - 255	Red 5
					14	14	14	14	14	14	14	14	000 - 255	Green 5
					15	15	15	15	15	15	15	15	000 - 255	Blue 5
					16	16	16	16	16	16	16	16	000 - 255	Red 6
					17	17	17	17	17	17	17	17	000 - 255	Green 6
					18	18	18	18	18	18	18	18	000 - 255	Blue 6
					19	19	19	19	19	19	19	19	000 - 255	Red 7
					20	20	20	20	20	20	20	20	000 - 255	Green 7
					21	21	21	21	21	21	21	21	000 - 255	Blue 7
					22	22	22	22	22	22	22	22	000 - 255	Red 8
					23	23	23	23	23	23	23	23	000 - 255	Green 8
					24	24	24	24	24	24	24	24	000 - 255	Blue 8
									25	25	25	25	000 - 255	Red 9
									26	26	26	26	000 - 255	Green 9
									27	27	27	27	000 - 255	Blue 9
									28	28	28	28	000 - 255	Red 10
									29	29	29	29	000 - 255	Green 10
									30	30	30	30	000 - 255	Blue 10
									31	31	31	31	000 - 255	Red 11
									32	32	32	32	000 - 255	Green 11
									33	33	33	33	000 - 255	Blue 11
									34	34	34	34	000 - 255	Red 12
									35	35	35	35	000 - 255	Green 12
									36	36	36	36	000 - 255	Blue 12
									37	37	37	37	000 - 255	Red 13
									38	38	38	38	000 - 255	Green 13
									39	39	39	39	000 - 255	Blue 13
									40	40	40	40	000 - 255	Red 14
									41	41	41	41	000 - 255	Green 14
									42	42	42	42	000 - 255	Blue 14
									43	43	43	43	000 - 255	Red 15
									44	44	44	44	000 - 255	Green 15
									45	45	45	45	000 - 255	Blue 15

CONTINUED ON NEXT PAGE

DMX TRAITS

CHANNEL													DMX VALUES	FUNCTION
6 CH	9 CH	13 CH	16 CH	18 CH	32 CH	32A CH	38 CH	43 CH	64 CH	78 CH	112 CH	127 CH		
									46	46	46	46	000 - 255	Red 16
									47	47	47	47	000 - 255	Green 16
									48	48	48	48	000 - 255	Blue 16
											49	49	000 - 255	Red 17
											50	50	000 - 255	Green 17
											51	51	000 - 255	Blue 17
											52	52	000 - 255	Red 18
											53	53	000 - 255	Green 18
											54	54	000 - 255	Blue 18
											55	55	000 - 255	Red 19
											56	56	000 - 255	Green 19
											57	57	000 - 255	Blue 19
											58	58	000 - 255	Red 20
											59	59	000 - 255	Green 20
											60	60	000 - 255	Blue 20
											61	61	000 - 255	Red 21
											62	62	000 - 255	Green 21
											63	63	000 - 255	Blue 21
											64	64	000 - 255	Red 22
											65	65	000 - 255	Green 22
											66	66	000 - 255	Blue 22
											67	67	000 - 255	Red 23
											68	68	000 - 255	Green 23
											69	69	000 - 255	Blue 23
											70	70	000 - 255	Red 24
											71	71	000 - 255	Green 24
											72	72	000 - 255	Blue 24
											73	73	000 - 255	Red 25
											74	74	000 - 255	Green 25
											75	75	000 - 255	Blue 25
											76	76	000 - 255	Red 26
											77	77	000 - 255	Green 26
											78	78	000 - 255	Blue 26
											79	79	000 - 255	Red 27

CONTINUED ON NEXT PAGE

DMX TRAITS

CHANNEL													DMX VALUES	FUNCTION
6 CH	9 CH	13 CH	16 CH	18 CH	32 CH	32A CH	38 CH	43 CH	64 CH	78 CH	112 CH	127 CH		
											80	80	000 - 255	Green 27
											81	81	000 - 255	Blue 27
											82	82	000 - 255	Red 28
											83	83	000 - 255	Green 28
											84	84	000 - 255	Blue 28
											85	85	000 - 255	Red 29
											86	86	000 - 255	Green 29
											87	87	000 - 255	Blue 29
											88	88	000 - 255	Red 30
											89	89	000 - 255	Green 30
											90	90	000 - 255	Blue 30
											91	91	000 - 255	Red 31
											92	92	000 - 255	Green 31
											93	93	000 - 255	Blue 31
											94	94	000 - 255	Red 32
											95	95	000 - 255	Green 32
											96	96	000 - 255	Blue 32
			13		25	25			49	49	97	105	000 - 255	White 1
			14		26	26			50	50	98	106	000 - 255	White 2
			15		27	27			51	51	99	107	000 - 255	White 3
			16		28	28			52	52	100	108	000 - 255	White 4
					29	29			53	53	101	109	000 - 255	White 5
					30	30			54	54	102	110	000 - 255	White 6
					31	31			55	55	103	111	000 - 255	White 7
					32	32			56	56	104	112	000 - 255	White 8
									57	57	105	113	000 - 255	White 9
									58	58	106	114	000 - 255	White 10
									59	59	107	115	000 - 255	White 11
									60	60	108	116	000 - 255	White 12
									61	61	109	117	000 - 255	White 13
									62	62	110	118	000 - 255	White 14
									63	63	111	119	000 - 255	White 15
									64	64	112	120	000 - 255	White 16

LED PIXEL ZONES

6-, 9-, 13-, AND 18-CHANNEL MODE

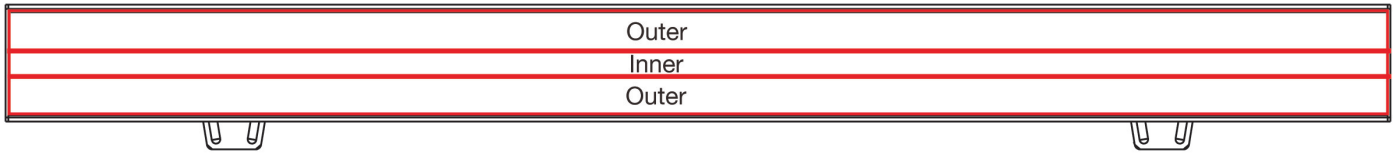

16-CHANNEL MODE

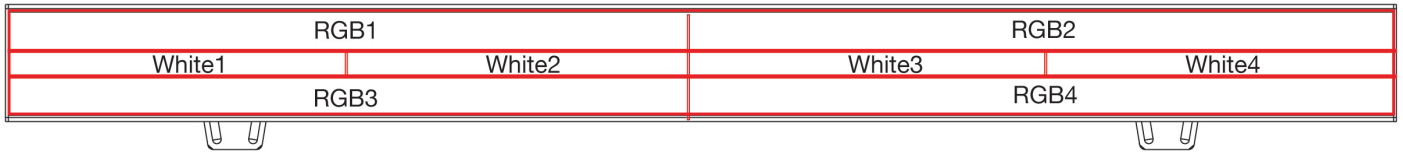

32-CHANNEL MODE

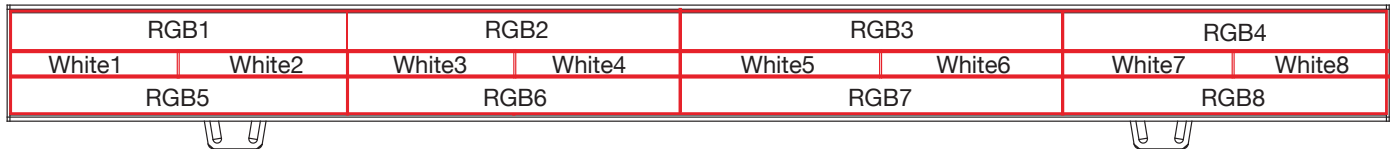

32A-CHANNEL MODE

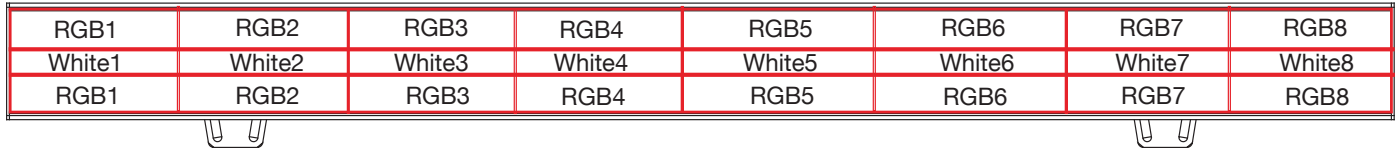

38- AND 43-CHANNEL MODE

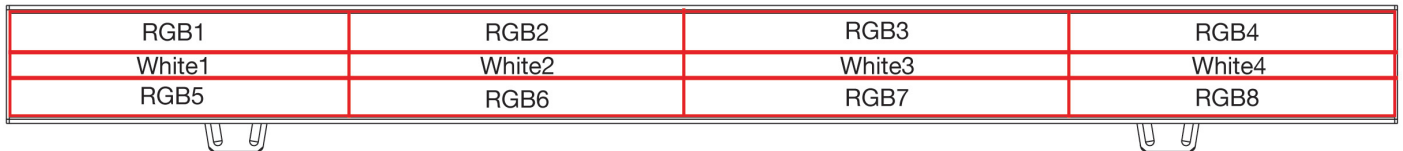

64- AND 78-CHANNEL MODE

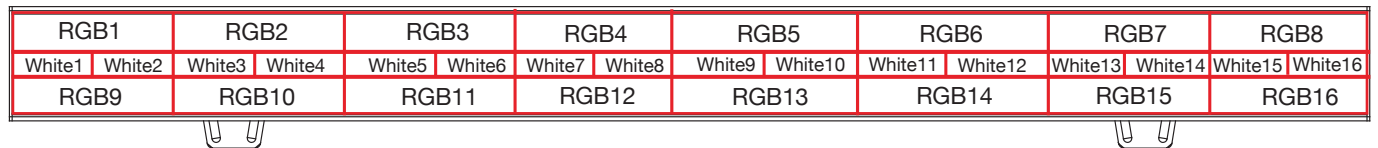

112- AND 127-CHANNEL MODE



COLOR MACRO CHART

MACRO NO.	DMX VALUE	RED	GREEN	BLUE
Off	000 - 009	0	0	0
Color1	010 - 017	255	0	0
Color2	018 - 024	255	50	0
Color3	025 - 032	255	100	0
Color4	033 - 039	255	150	0
Color5	040 - 047	255	200	0
Color6	048 - 054	255	255	0
Color7	055 - 061	200	255	0
Color8	062 - 069	150	255	0
Color9	070 - 076	100	255	0
Color10	077 - 084	50	255	0
Color11	085 - 091	0	255	0
Color12	092 - 099	0	255	50
Color13	100 - 106	0	255	100
Color14	107 - 113	0	255	150
Color15	114 - 121	0	255	200
Color16	122 - 128	0	255	255
Color17	129 - 136	0	200	255
Color18	137 - 143	0	150	255
Color19	144 - 151	0	100	255
Color20	152 - 158	0	50	255
Color21	159 - 165	0	0	255
Color22	166 - 173	50	0	255
Color23	174 - 180	100	0	255
Color24	181 - 188	150	0	255
Color25	189 - 195	200	0	255
Color26	196 - 203	255	0	255
Color27	204 - 210	255	0	200
Color28	211 - 217	255	0	150
Color29	218 - 225	255	0	100
Color30	226 - 232	255	0	50
Color31	233 - 240	255	0	0
Color32	241 - 247	255	0	255
Color33	248 - 255	255	255	255

DIMMER MODES AND CURVES

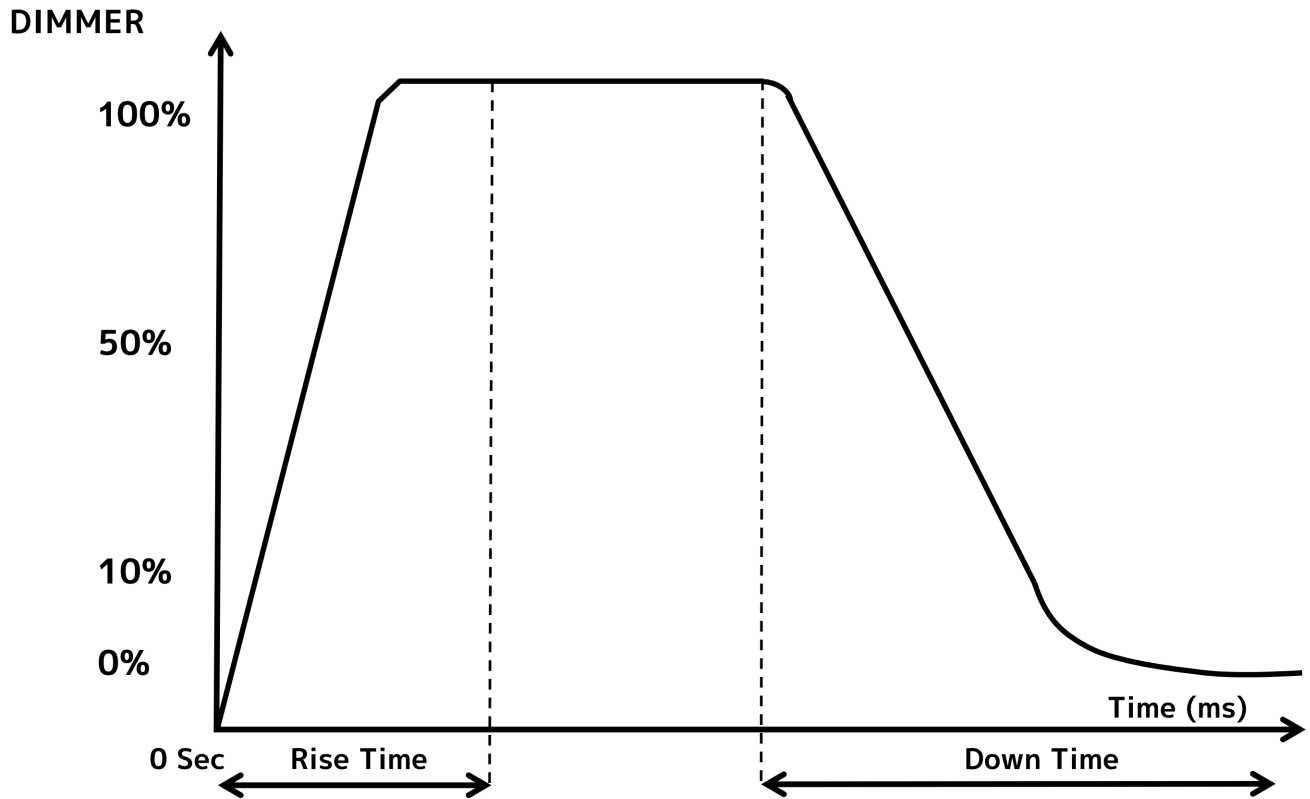

Dimming Curve Ramp Effect	0 sec Fade Time		1 sec Fade Time	
	Rise Time (ms)	Down Time (ms)	Rise Time (ms)	Down Time (ms)
Standard (default)	0	0	0	0
Stage	780	1100	1540	1660
TV	1180	1520	1860	1940
Architectural	1380	1730	2040	2120
Theatre	1580	1940	2230	2280
Stage 2	0	1100	0	1660

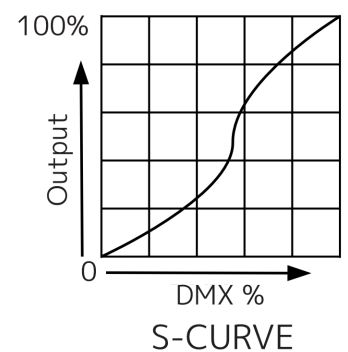
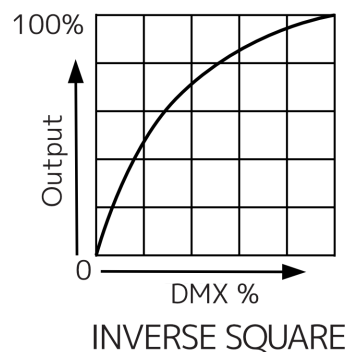
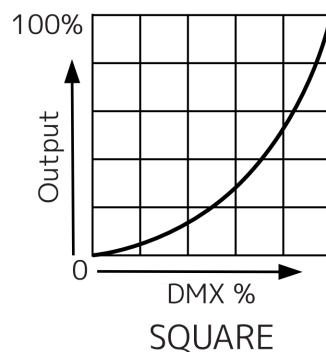
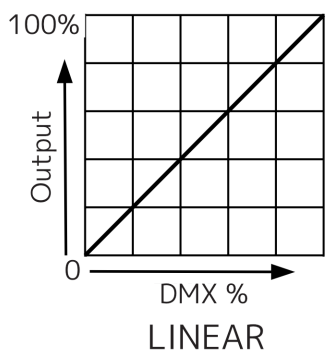

DAISY CHAIN POWER LINKING

These units have the capability to be daisy chained together via the power in/out ports. **The maximum number of units that can be linked together in this manner is as follows:**

- 4 units maximum when running on 120V power.
- 7 units maximum when running on 230V power.

DO NOT EXCEED THE NUMBER OF UNITS LISTED ABOVE.

DO NOT MIX MAKE AND MODEL TYPES WHEN DAISY CHAINING! All units that are connected in this manner must be of the same make and model type.

CLEANING AND MAINTENANCE



DISCONNECT POWER BEFORE PERFORMING ANY MAINTENANCE!

CLEANING

Frequent cleaning is recommended to ensure proper function, optimized light output, and an extended life. The frequency of cleaning depends on the environment in which the fixture operates: damp, smoky, or particularly dirty environments can cause greater accumulation of dirt on the fixture's optics. Clean the external lens surface periodically with a soft cloth to avoid dirt/debris accumulation.

NEVER use alcohol, solvents, or ammonia-based cleaners.

MAINTENANCE

Regular inspections are recommended to ensure proper function and extended life. There are no user serviceable parts inside this fixture. Please refer all other service issues to an authorized ADJ service technician. Should you need any spare parts, please order genuine parts from your local ADJ dealer.

Please refer to the following points during routine inspections:

- A detailed electrical check by an approved electrical engineer every three months, to make sure the circuit contacts are in good condition and prevent overheating.
- Be sure all screws and fasteners are securely tightened at all times. Loose screws may fall out during normal operation, resulting in damage or injury as larger parts could fall.
- Check for any deformations on the housing, color lenses, rigging hardware, and rigging points (ceiling, suspension, trussing). Deformations in the housing could allow for dust or liquids to enter into the fixture. Damaged rigging points or unsecured rigging could cause fixture to fall and seriously injure a person(s).
- Electric power supply cables must not show any damage, material fatigue, or sediments.

NEVER remove the ground prong from the power cable.

DIMENSIONS

Dimensions are not drawn to scale.

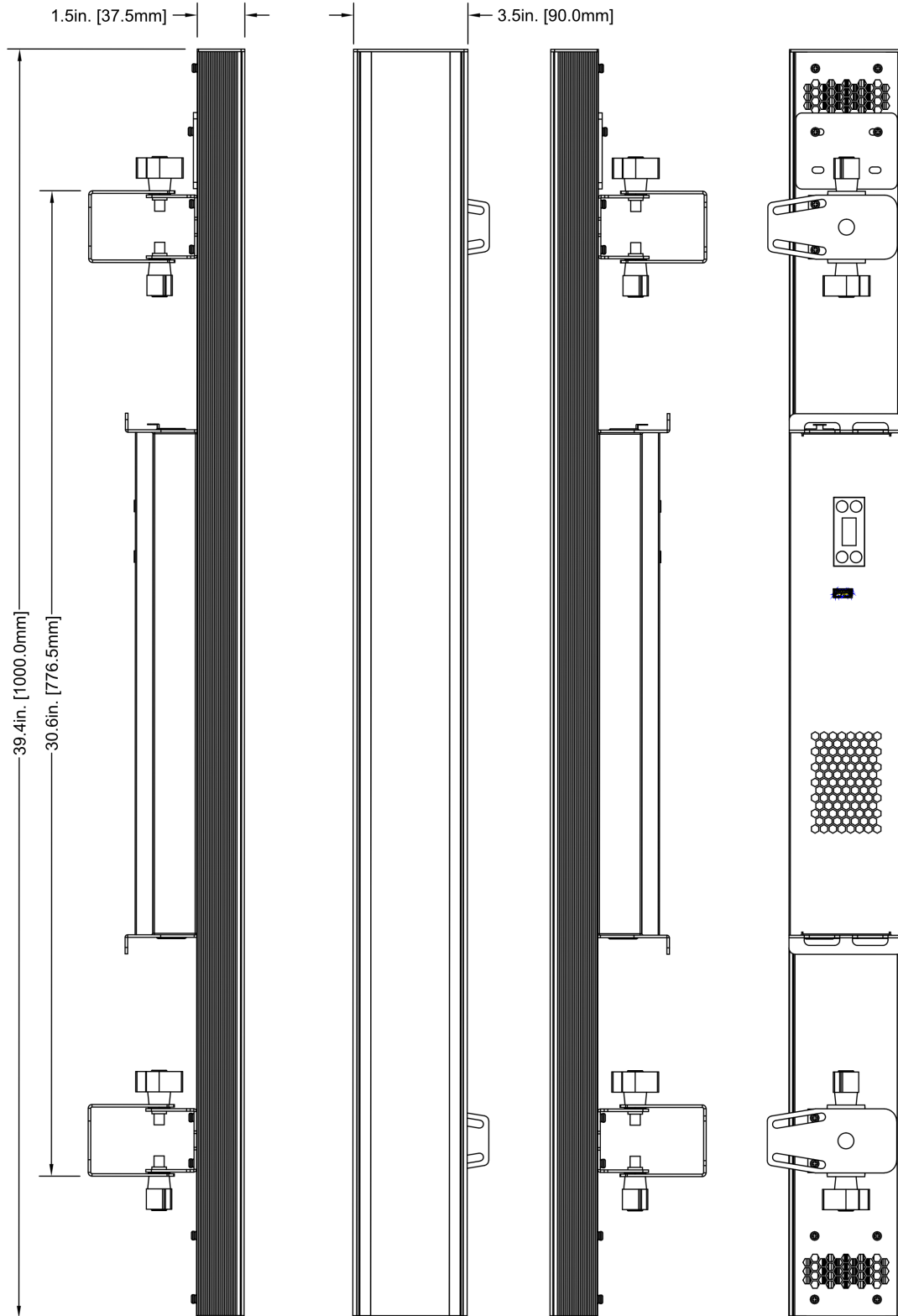
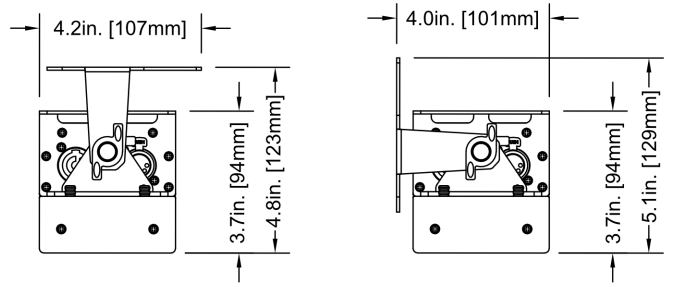

SPECIFICATIONS

LIGHT SOURCE:

- 448 x 0.3W RGB SMD LEDs + 112 x 5W Cool White SMD LEDs
- 116 Degree Beam Angle
- Color Temperature: Red: 620-630nm. Green: 515-525nm. Blue: 460-470nm. / Cool White: 5000-6500K
- 50,000 Hour Average LED Life

FEATURES:

- 32 x RGB LED zones
- 16 x Cool White LED
- 25 built-in RGB LED Program Macros
- 9 built-in Cool White LED Program Macros

CONTROL:

- Control Protocol: DMX
- 13 DMX Modes: 6, 9, 13, 16, 18, 32, 32A, 38, 43, 64, 78, 112 and 127 channels
- Dim Modes: 6 Presets (Standard, Stage, TV, Architectural, Theatre, & Stage 2)
- Dim Curves: 4 Presets (Linear, Square, Inverse Square, and S Curve)
- 0-100% Smooth Dimming
- Strobe, shutter & pulse control
- Max Strobe Rate 25Hz. Min Strobe Rate: 0.35Hz.
- With Wired Digital Communication Network
- Display: OLED display with 4-button touch menu

CONNECTIONS:

- Data: 5-pin DMX In/Out
- 180 degree mounting bracket system
- Power locking power in/out
- Connect fixtures seamlessly using included metal bracket attachment

ELECTRICAL:

- 100-240V, 50Hz/60Hz (Auto Sensing)
- Max Power Consumption: 430W

DIMENSIONS / WEIGHT:

- Length: 39.4" (1000mm)
- Width: 4.2" (107mm)
- Height: 4.8" (123mm)
- Weight: 16.5 lbs. (7.5kg)

CERTIFICATIONS:

- cETLus approved (control #4000358)



Specifications and manual are subject to change and improvement without prior written notice.

FCC STATEMENT

This device complies with Part 15 of the FCC Rules ADJ PRODUCTS LLC 6122 S. Eastern Ave, Los Angeles, CA, 90040. Operation is subject to the following two conditions: (1) this device may not cause harmful interference, and (2) this device must accept any interference received, including interference that may cause undesired operation. Please note that changes or modifications of this product is not expressly approved by the party responsible for compliance could void the user's authority to operate the equipment.

FCC RADIO FREQUENCY INTERFERENCE WARNINGS & INSTRUCTIONS

This product has been tested and found to comply with the limits as per Part 15 of the FCC Rules. These limits are designed to provide reasonable protection against harmful interference in a residential installation. This device uses and can radiate radio frequency energy and, if not installed and used in accordance with the included instructions, may cause harmful interference to radio communications. However, there is no guarantee that interference will not occur in a particular installation. If this device does cause harmful interference to radio or television reception, which can be determined by turning the device off and on, the user is encouraged to try to correct the interference by one or more of the following methods:

- Reorient or relocate the device.
- Increase the separation between the device and the receiver.
- Connect the device to an electrical outlet on a circuit different from which the radio receiver is connected.
- Consult the dealer or an experienced radio/TV technician for help.

Europe Energy Saving Notice

Energy Saving Matters (EuP 2009/125/EC)

Saving electric energy is a key to help protecting the environment. Please turn off all electrical products when they are not in use. To avoid power consumption in idle mode, disconnect all electrical equipment from power when not in use. Thank you



