



ADMIRAL
STAGING







CONTENTS

01 TRANSPORT	4
02 RIGGING	33
03 GRID SYSTEM	36
04 CABLE GUIDES	42
05 BUILD A RAMP	48
06 LIGHTING	54
07 TRUSS ACCESSORIES	58
08 CLAMPS & SAFETIES	68
09 TEXTILES	74
10 CABLES & CONNECTORS	82
11 OUR DISTRIBUTORS	90

TRANSPORT

The Admiral Staging range includes numerous transport solutions for a wide variety of applications. With our modular transport system you can build your own transport cart step-by-step, choosing the desired parts, heights and lengths to best suit your needs. This modular system allows you to design a cart to transport fixtures, ballet floors, cables or even a storage space for your tools and essentials. Are you in need of some strong and sturdy helpers for transporting truss, baseplates or stage decks? Our Strong Family of truss dollies includes options suitable for both straight or circular 30- and 40-truss. Our baseplates and stage decks transporters are ergonomically designed to load and unload your equipment in a safe way.

01



01 TRANSPORT

MODULAR TRANSPORT	7
MEATRACK	8
CABLE CART	10
STORAGE CART	12
BALLETFLOOR CART	14
BASEPLATE DOLLY	16
SIDELIGHT TOWER	18
STRONG BOY®	20
STRONG GIRL	21
STRONG BOY MINI®	22
STAGEDECK DOLLY	23
LIFTING WHEEL	24





Location:
Metropool



Location:
Wilminktheater

MODULAR TRANSPORT

MEATRACK

Use our modular transport system to design your ideal Meatrack for the transport and storage of fixtures such as moving heads, lighting bars or single luminaires. You can build a Meatrack frame using our Fork-side panels, which are available in two heights, 110 cm and 203 cm, and length profiles in different lengths. Depending on the amount and size of your fixtures, either aluminium or steel hanging tubes are chosen to create the desired storage space for your fixtures.



BUILD A MEATRACK STEP BY STEP

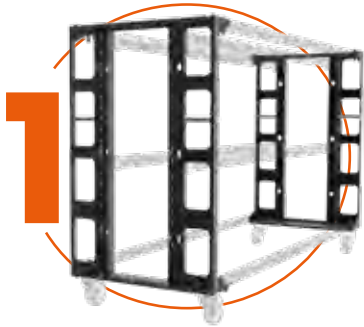

CHOOSE SIDE PANELS

Depending on the size and weight of the fixtures you want to store and transport, you choose side panels in either 110 cm or 203 cm. Pre-drilled holes in the side panels allow you to hang tubes in the Meatrack frame at different heights, allowing you to use the space in your cart as

efficiently as possible. Adding a centre bracket to your Meatrack provides you with more hanging options for your fixtures. These centre brackets are mounted in the fork-side panels and allow you to hang larger fixtures in the centre of the Meatrack. All of our fork-side panels

are equipped with handles which are convenient when moving around your Meatrack.

Heights:

- 110 cm
- 203 cm



CHOOSE LENGTH PROFILES

Length profiles are available in sets of 4 profiles with a length of 80 cm, 160 cm, 180 cm and 210 cm. Together with the fork-side panels these create the frame for your Meatrack. While choosing the length profiles, you

need to take the total weight of your Meatrack into consideration. If you want to store heavy fixtures, we recommend creating a compact frame, using higher fork-side panels in combination with shorter length profiles.

Length profiles:

- 80 cm
- 160 cm
- 180 cm
- 210 cm



CHOOSE CASTORS

After selecting the preferred fork-side panels and length profiles, it's now time to choose which type of castors you want to mount under your cart. The Admiral castors are perfect for this job as they don't leave any marks on soft surfaces such as gym floors or dance halls.

For this cart, we recommend using swivel castors, with a diameter of 100 mm or 125 mm. These are available in sets, each set including four castors with and without a brake. Based on the weight of the fixtures you are planning to hang in your Meatrack, you choose castors with

the appropriate load capacity.

Castor sets:

- 100 mm castor, load capacity of 160 kg per castor
- 125 mm castor, load capacity of 200 kg per castor



CHOOSE HANGING TUBES

Depending on the amount and size of the fixtures you want to store in the Meatrack, you choose hanging tubes with the same length as your frame. Hanging tubes are available in several lengths

and, depending on the length, are made out of steel or aluminium. Each tube comes with a forkset, which includes all the necessary parts to hang the tubes in your Meatrack.

Hanging tubes:

- 80 cm, aluminium
- 160 cm, aluminium
- 180 cm, aluminium
- 210 cm, steel

CABLE CART

Our Cable cart is not a standard cable organizer, but a 2-in-1 innovative solution that enables you to store and transport your heavy-duty cables efficiently, all in one cart.

Using slim-line panels from our modular system, you can design your ideal cart with a length of 80, 160 or 210 cm. The orange handles are designed to assist you in moving the cart and lifting it over small bumps. Sturdy cable forks, designed to preserve the lifespan of your equipment, are placed over support profiles to create hanging space for your cables.



BUILD A CABLE CART STEP BY STEP



CHOOSE SIDE PANELS

Choose the desired height depending on the amount of cables you need to store in your Cable cart. This cart is available in a height of 110 cm or 203 cm, using our slim-line panels with centre brackets. These centre brackets

are mounted in the slim-line panel and allow you to hang cables on each side of the hanging tubes, providing you with as much hanging space as possible. Our slim-line panels are equipped with orange handles for your convenience

while moving around your Cable cart.

Heights:

- 110 cm
- 203 cm

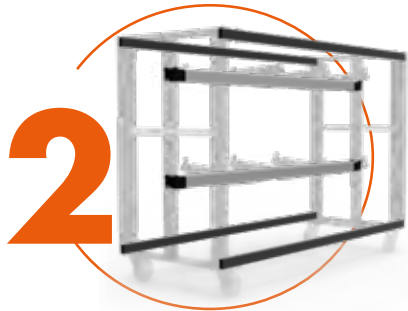

CHOOSE LENGTH AND SUPPORT PROFILES

Our length profiles are available in sets of 4 and, together with the slim-line panels, they create the frame of your Cable cart. While choosing the length profiles, the total weight of your cart needs to be taken into consideration. If you want to store a lot of heavy duty cables, we recommend creating a compact frame.

The support profiles are the tubes on which cable forks are hung. While choosing the support profiles, we advise you to double check whether they have the same size as the length profiles chosen. Every support profile comes with a forkset to mount the tubes on the centre brackets of the side panels.

Length and support profiles:

- 80 cm
- 160 cm
- 210 cm



CHOOSE CASTORS

After creating the frame of your Cable cart, it's now time to choose which type of castors you want to mount under it. The Admiral castors are perfect for this job as they don't leave any marks on soft surfaces such as gym floors or dance halls. For this cart, we recommend using

swivel castors, with a diameter of 100 mm or 125 mm. These are available in sets, each set including four castors with and without a brake. Depending on the type of cables you want to hang in the Cable cart, you choose castors with the appropriate load capacity.

Castor sets:

- 100 mm castor, load capacity of 160 kg per castor
- 125 mm castor, load capacity of 200 kg per castor



CHOOSE CABLE FORKS

Our black aluminum cable forks are the parts on which you hang your cables. They have a length of 55 cm and create enough hanging space on each side for

you to organize your cables neatly in your cart. Choose the amount of cable forks depending on the type and number of cables you want to store in your Cable cart.

Each cable fork comes with a screwset to mount the forks on the cable support profiles.

STORAGE CART

Put together your ideal storage solution with our modular Storage cart.

Our modular system allows you to build a transport cart in two different heights, 110 cm or 203 cm. Sturdy crates in six different sizes can be mixed and matched to design the interior of the cart, allowing you the flexibility of storing your tools, supplies and other essentials however you want.

Equipped with heavy duty castors and a solid frame, this cart is suitable for both storing and transporting your supplies.



BUILD A STORAGE CART STEP BY STEP



CHOOSE A HEIGHT

We offer two frame sets, each coming with a top lid to prevent dust and dirt from falling into the top crate of your cart. The lid is made from a sturdy physiochemical board that offers improved scratch resistance.

By being mounted with screws that fall into it, the surface of the cart remains smooth and even, allowing for additional equipment to be easily and securely stacked on top.

Heights:

- 110 cm
- 203 cm



CHOOSE THE CASTORS

Our blue castors fit perfectly under our Storage carts as they don't leave any marks on soft surfaces. We recommend using our 100 mm or 125 mm swivel castors depending on how much weight you are planning to store in your Storage cart.

We have created several castor sets, each set including four castors with and without a brake. Based on the type of supplies you want to store in the Storage cart, you choose castors with the appropriate load capacity.

Castor sets:

- 100 mm castor, load capacity of 160 kg per castor
- 125 mm castor, load capacity of 200 kg per castor

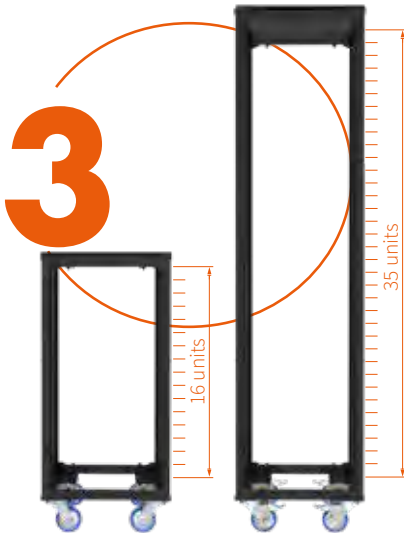

CHOOSE STORAGE CRATE SETS

To complete your Storage cart we have a wide selection of sturdy storage crates available. With a fixed size of 60 cm x 40 cm (L x W) and different height sizes, you can be as flexible as you want when customizing your Storage cart. Every crate comes with drawer profiles which can be mounted in the slim-line panel with

two M6 bolts. To determine the number of crates that can fit in your Storage cart based on its design, we have created a Unit chart. Each unit takes up 5 cm of space in your cart. Therefore, you can fit a total of 16 units in a Storage cart with a height of 110 cm and 35 units in a cart with a height of 203 cm.

Below you can see our selection of crates, each with an indication of how many units they will take up in the Storage cart's frame. Simply add crates until you have reached the maximum amount of units that fit your frame.



BALLETFLOOR CART

Whether you need to store or transport your stage and dance floors, our clever Balletfloor cart is there to help you do it efficiently and reliably. The cart can be loaded thanks to the foldable handle that helps roll the floor onto the inner plastic tubes. These sturdy tubes also ensure your floor is being held in a proper shape that will help maintain its longevity and won't allow it to be flattened and potentially damaged.



BUILD A BALLETFLOOR CART STEP BY STEP



CHOOSE THE LENGTH

The Balletfloor cart consists of several parts from our modular transport system. Two fork-side panels with a height of 110 cm are combined with length profiles of different lengths, 180 cm,

210 cm or 230 cm, to create the frame of the cart. Depending on the width of your stage floor, you can select the appropriate length for your cart.

Floor width :

- up to 150 cm: choose the 180 cm profiles
- up to 190 cm: choose the 210 cm profiles
- up to 200 cm: choose the 230 cm profiles



Six sturdy plastic tubes are placed in the base of this cart. Each tube has a metal strip to line up the balletfloor. The tubes are rotated with a handle, which can be easily folded between the side

panels after use. The thickness of your ballet - or stagefloor determines how many meters of floor you can roll on each tube:

Material thickness:

- 1.6 mm: max. 30 meter floor
- 2 mm: max. 25 meter floor



CHOOSE THE CASTORS

Now that you've created the frame for your Balletfloor cart, it's time to choose which type of castors you would prefer to mount under the cart. Our blue Admiral castors do not leave any marks on soft surfaces such as gym floors or dance halls. We advise you to use 160 mm castors, with a load capaci-

ty of 300 kg each, to bear the weight of a fully loaded Balletfloor cart. We strongly recommend including at least 2 castors with brake when choosing the desired castor set.

Castor sets:

- 160 mm castor, load capacity of 300 kg per castor

BASEPLATE DOLLY

Our Baseplate dolly 2.0 is a robust, ergonomic and customizable baseplate transporter. Thanks to its PE holders equipped with guide profiles, you can comfortably place baseplates onto the dolly, only moving them into a vertical position at the last moment. These holders also protect the baseplates from getting scratched when loading them on and off. Sturdy 160 mm castors ensure a smooth ride over bumps and uneven surfaces.



PE (polyethylene) holders to protect baseplates.



73 cm
80 cm
100 cm

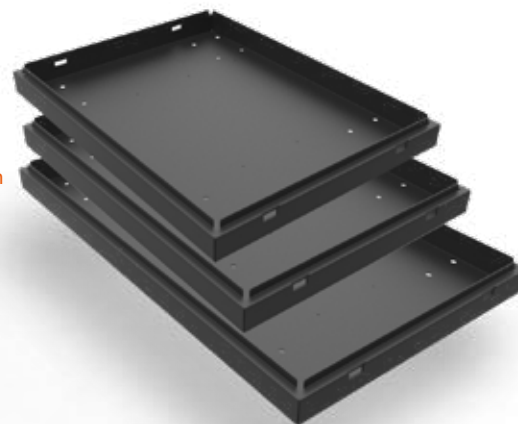

BUILD A BASEPLATE DOLLY STEP BY STEP

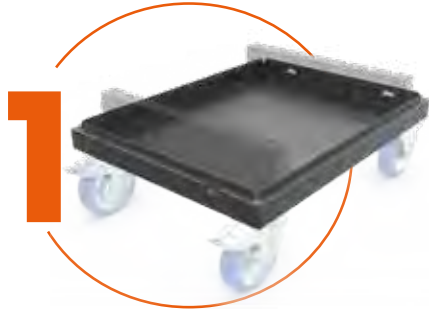

CHOOSE A FRAME

To build a Baseplate dolly that fits the dimensions of your baseplates you have to choose one of the three available frame sizes: frame 73, 80 or 100. Each frame has pre-drilled holes for

mounting the castors and has been made “hood ready” with four cutouts for the butterfly locks of an optional flightcase cover.

Frame sizes:

- Dolly frame 73, 77 cm x 59 cm (L x W)
- Dolly frame 80, 84 cm x 59 cm (L x W)
- Dolly frame 100, 104 cm x 59 cm (L x W)

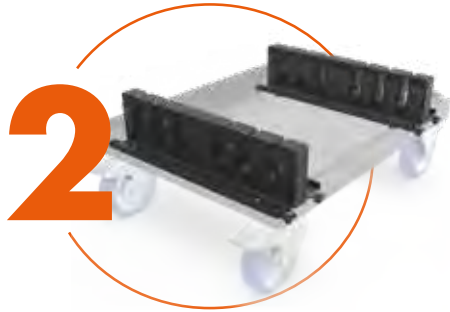

CHOOSE THE HOLDERS

Our PE holders are the key to our ergonomically designed Baseplate dolly. The holders are equipped with a guide profile which allows you to comfortably place the plates onto the dolly, only moving into a vertical position at the last

moment. The plates will slide easily into their designated place and when they reach a vertical position, they are safely and stably stored. There are three types of baseplate holders available, each set containing two holders.

Holder sets:

- 6 mm for 6 x 6 mm baseplates
- 8 mm for 6 x 8 mm baseplates
- 10 mm for 4 x 10 mm baseplates



CHOOSE THE CASTORS

Adding castors is the final step when building your own Baseplate dolly. Our blue castors do not leave any marks on ballet floors or other soft surfaces.

To bear the weight of a fully loaded Baseplate dolly, it's best to choose our 160 mm castors with brakes, with a load capacity of 300 kg each.

Castor sets:

- 160 mm castor, load capacity of 300 kg per castor

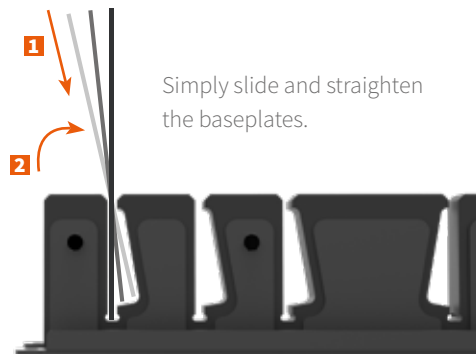

SIDELIGHT TOWER

Mount your fixtures in our towers, transport them to the location, push the ladder up by hand and use them as a Sidelight tower on stage! Sidelight towers can be equipped with moving heads, theatre luminaires and other lighting fixtures. The height of the tower of 200 cm, can be increased with 100 cm by pulling the ladder up.

The position of the ladder can be symmetrical or asymmetrical, depending on the type of fixtures you want to use. The symmetrical Sidelight tower can be used for smaller fixtures such as LED par spotlights, small moving heads, blinders and strobes. Larger moving heads and profile spots fit the Sidelight tower when the ladder is positioned asymmetrically. In this position there is more place in front of the ladder to position and aim your profile spots in the desired direction.





The telescopic ladder inside the Sidelight tower consist of a frame with two hanging bars: one at the top and one at the bottom. Two separate hangers with forksets are also provided, so they can be installed in the middle of the ladder frame.



The ladder is equipped with bearing wheels that allow it to slide easier. The wheels are adjustable, so the slack of the ladder in the Sidelight tower can be eliminated.



A cord with handles on both sides helps you lift the ladder up before inserting the locking pin to secure it in place.



When the ladder is lifted up, two extra tubes can be mounted in the bottom side of the Sidelight tower to create shinlights. These tube are mounted on the outer frame of the tower.

To safely operate the Sidelight tower, the maximum weight of the ladder while lifting it should not exceed 25 kg per person. Therefore, the ladder should be loaded with up to 40 kg and always pulled up with two people to a maximum of 100 cm. When the ladder is already secured, it can be loaded up to 100 kg.



40 kg while lifting,
always pull up with 2 people



100 kg
while secured

STRONG BOY[®]

Our Strong Boy is a strong cart! Suitable for both 30 and 40 truss, the Strong Boy is the perfect solution for transporting straight truss securely and effortlessly. The cart has a sturdy base made of strong 2 and 3 mm steel and it's equipped with rubber studs for an optimal friction of your truss. Hooks can be applied on each side of the dolly to secure the load. Hooks can be applied on each side of the dolly to secure the load.

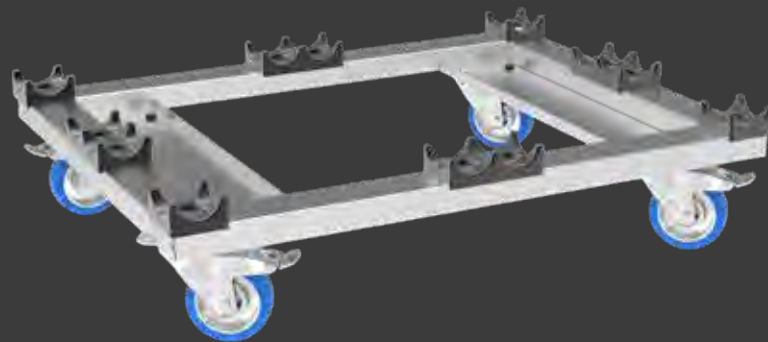

Hook profile for straps



Stackable



Storage space for carriers 30 truss

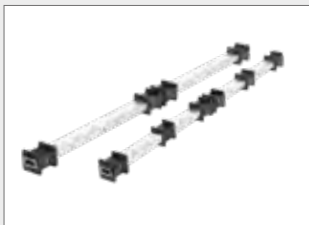

Use our truss carriers (page 56)

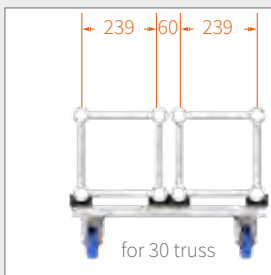

for 30 truss

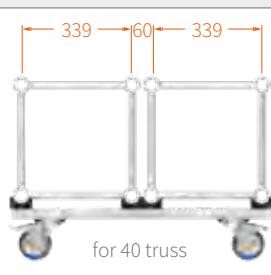

for 40 truss

Centre-to-centre distance



Compatible with all Prolyte 30 and 40 trusses

STRONG GIRL

Our Strong Girl is designed for transporting circular trusses with a square cross section and an outer diameter from 2,5 m up to an infinite diameter. Its frame is made of 3 mm zinc-plated steel and it is equipped with cutouts for attaching the hooks of your straps, so your load can be secured. The frame of the dolly is equipped with rubber studs which ensure an optimal positioning of your truss. Two versions are available, one for 30 truss and one for 40 truss.



For every radius



Rubber studs prevent slipping



Hook profile for straps

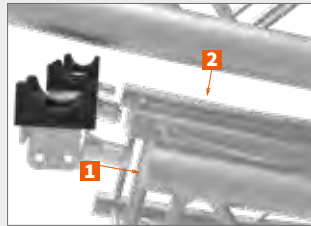

To stack, assemble the carriers with a conical coupler to the truss

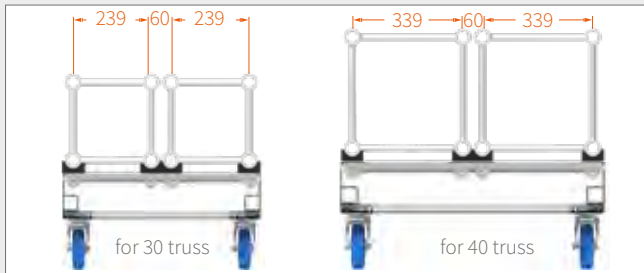

Centre-to-centre distance



Compatible with all Prolyte 30 and 40 trusses

STRONG BOY MINI[®]

This lighter and smaller version of the Strong boy will come in handy in many situations. When loading the Strong Boy with truss, use it together with its mini version so you can ride the loaded dolly up a ramp without any difficulties.

Besides using it in combination with the Strong boy, you can also use two mini dollies at the same time to transport truss 30.

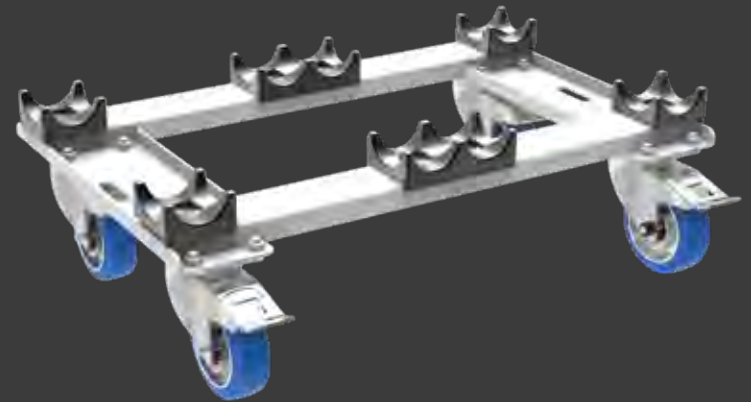

Compact design



Hook profile for straps

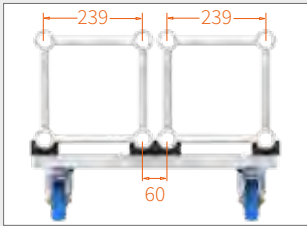

Centre-to-centre distance

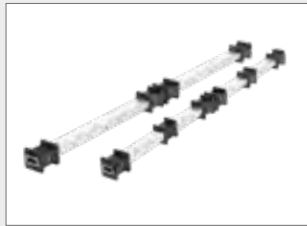

Use our truss carriers (page 56)



Use the Strong Boy mini to ride your truss up a ramp



Compatible with all Prolyte 30 trusses

STAGEDECK DOLLY

Cost-effective and a time saver, our Stagedeck dolly allows you to efficiently transport up to six stage decks at once. Due to its ergonomic design, the stage elements can be easily slid into place, thus preventing excess pressure on your back while loading the cart.

The Stagedeck dolly comes in two versions, suitable for 1x1 meter decks and 1x2 meter decks respectively.



Ergonomic design



Two safety measures



Transports up to 6 decks



For 1 x 1 and 1 x 2 m decks

Compatible with:
Prolyte, Sixty82,
Bütec ECO1.



LIFTING WHEEL

With a maximum load of 130 kg, our multifunctional Lifting wheel enables you to move your stage decks, truss parts, and other décor pieces smoothly. The wheel comes equipped with an 80 mm castor that can move 27 mm up and down. When lowered, the lifting wheel can handle the maximum load of your stage deck.



NOTE The Lifting wheel is only meant for moving a stage. It should be lifted off the ground before using the maximum load of the stage decks.

3 WAYS TO USE

1



STAGE RISER

Mount the lifting wheel directly on square stage legs or use half couplers to mount it on round stage legs. In addition to that, it is even possible to mount it to two round legs using the mounting plate for the Lifting wheel. When no additional movement is required, lift the wheel off the floor and you can use the maximum load of your stage.

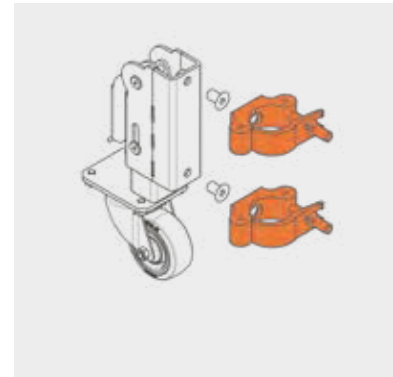

2



TRUSS MOVER

Mount the lifting wheel on your truss frame, such as a DJ booth, with a truss attachment and roll it easily on and off stage.

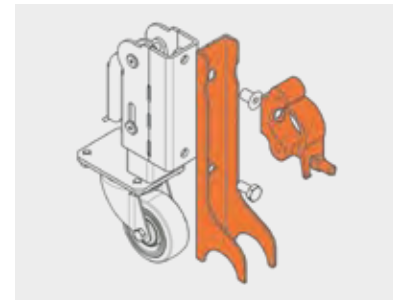

3



BOX RISER

Wooden boxes or other types of décor pieces can also be quickly moved around by attaching the wheel with a mounting plate attachment.

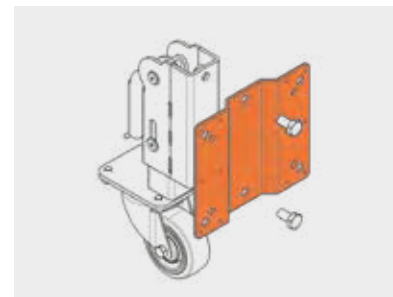

RIGGING

When it comes to rigging your show equipment, you need options that offer both flexibility and security. That's where our range of rigging options comes in.

With our solutions, you have the flexibility to construct your setup in any way you see fit. Whether you need to suspend your equipment or build a standing structure, assemble something simple or a more complex setup, our products offer the versatility you need to make it happen.

02



02 RIGGING

FREEDOM MODULAR RIGGING	28
SINGLE RIGGER	30
DOWN RIGGER	31
DROP ARM	32
FLOOR RACK	33
LOW HANGER TUBE	34



FREEDOM MODULAR RIGGING

One of the most versatile products in our range is the Freedom system. This modular rigging system removes any traditional constraints and allows you to easily build your light show either suspended or standing, with different length and width variations. What's more, you can rig any kind of luminaire, from pars and spots to moving heads.

Get creative and combine the components of this system to set up Single riggers, Down riggers, Drop arms or Floor racks in your ideal construction.

BASIC PARTS FREEDOM

The Freedom system consists of several basic components that can be combined in numerous configurations.

By connecting profiles with each other using the coupler set, the height can be easily adjusted, while the width can be customised by using different lengths of hanging tubes.

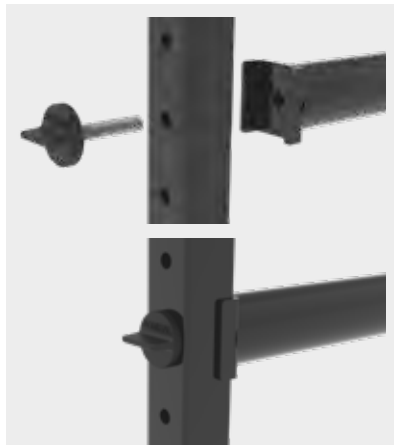

Length profiles
0.5 / 1 / 1.5 / 2 m



2 BASIC PARTS

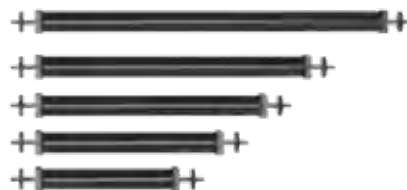

Hanging tubes
30 / 40 / 50 / 60 / 80 cm



SAFETY SET

Always use the Freedom safety to attach a secondary safety device, such as a safety cable, to ensure a secure connection between your system and the supporting structure.

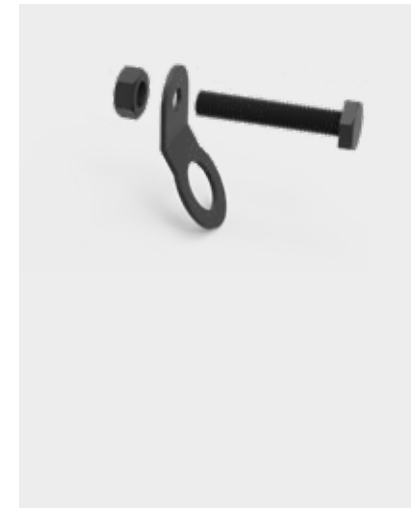

NUTPLATE SET

To attach a clamp or coupler to a length profile, a nut plate set is used. For the Single rigger, two sets of nut plates are connected at the top and bottom of the profile. For the 'Down rigger' setup, two nut plate sets are attached at the top of the profiles.



COUPLER SET

To extend your Freedom configuration to the desired length, a convenient coupling set is available for connecting two length profiles. This profile coupler set is provided with all the bolts and nuts necessary for assembly.



For detailed instructions and information, please refer to the product manual.

SINGLE RIGGER

Start building your light show around the Admiral Single riggers and create a spectacular wall of light for your show. The Single rigger is a simple solution that creates a wonderful effect using length profiles from our Freedom system. The Single rigger can be extended past its regular length by connecting multiple profiles together.



DOWN RIGGER

Combine length profiles with hanging tubes and set up one or even multiple Down riggers to create an impressive light structure. Adding hangers between our length profiles provides you with the possibility to hang multiple fixtures in a row.

Like the Single riggers, each length profile can be extended in length, but with a Down rigger set you can even create a drop of 6 meters!



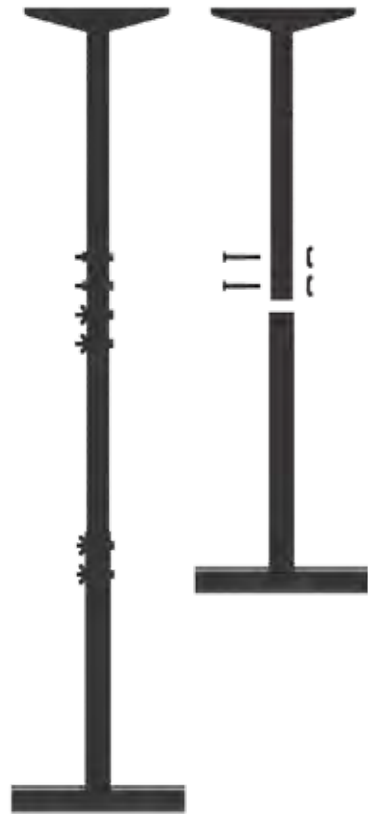

DROP ARM

You might have seen them before, but never this clever!

With our Drop Arms, you can easily suspend your equipment from a truss or fixed tube. The Drop Arms can be extended in length and they can also be combined with hanging tubes. Just imagine all the lighting effects you can create!



FLOOR RACK

Have you already gotten your hands on our Down rigger system? Then you are one step away from using it as a lighting tower.

You simply turn a Down rigger upside down, slide it into its aluminium bases and your Floor rack is born. You can use it as a sidelight tower, moving head tower or floor stand. Our modular system allows you to easily expand your Floor rack construction horizontally by joining Floor racks to each other using hangers.

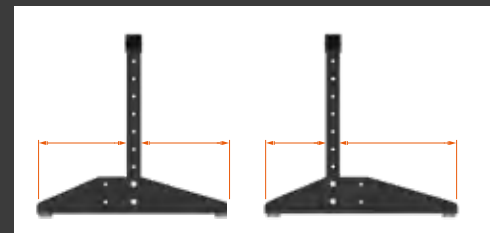

Position your profiles symmetrically or asymmetrically into the foot.

LOW HANGER TUBE

These versatile hanger tubes are the perfect tool for easily rigging equipment such as lighting fixtures, video projectors, sound systems, etc. With a clean and modern design, these tubes seamlessly integrate into any setup. Equipped with an M10 bolt fitting, they can be connected to your gear, clamps or couplers in no time. Two gaps at the ends of the tubes enable you to easily secure them and your equipment with safety cables.



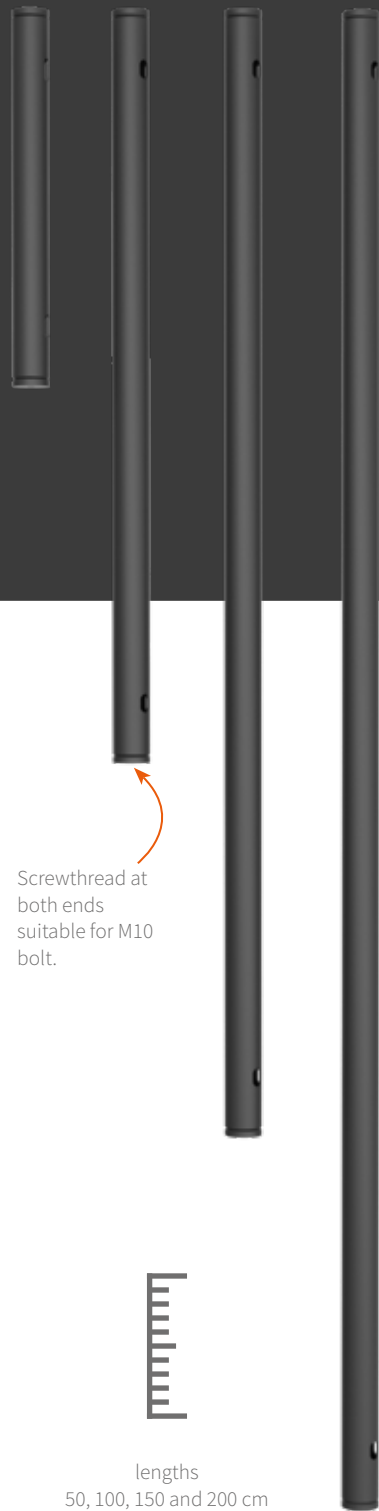

Screwthread at both ends suitable for M10 bolt.

lengths
50, 100, 150 and 200 cm



200 kg



Two gaps for the safety cable.

GRID SYSTEM

Versatile and sturdy, the Admiral Grid is the ideal solution for improving the flexibility of your club, conference room, theatre space or retail location. Designed as a modular system, you can easily choose the components that will allow you to build the rigging option most suitable for your own space and needs.

Whether you need to install lighting in a theatre with low stage clearance, rig a projector in a college room, or hang display items in a fashion store, the Admiral Grid system is the perfect fit. Optionally, AC power sockets, signal-connections or network infrastructure can be added, creating the perfect infrastructure for your venue.

03

03 GRID SYSTEM

BUILD A GRID
FLEXIBLE GRID

38
41





BUILD A GRID



1 GRID ALUMINIUM TUBE

The black coated grid tubes are the base of the Admiral Grid system. Available in 3 and 6 m lengths.



2 GRID BRACKET 48/51 mm

Mount the grid tubes to the ceiling with this adjustable bracket.



3 GRID WALL BRACKET

Mount the grid tubes firmly to the wall with our Wall bracket.

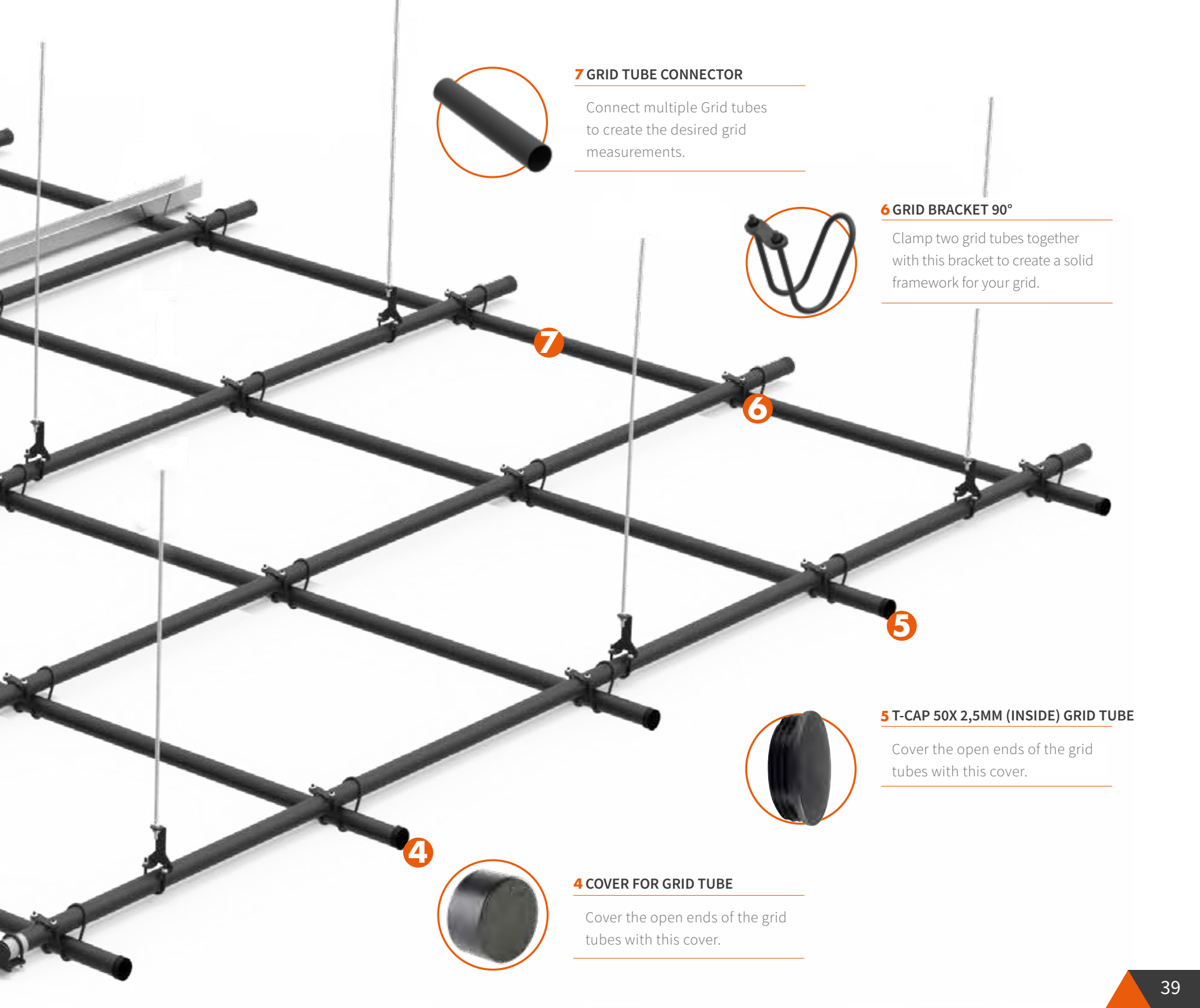

7 GRID TUBE CONNECTOR

Connect multiple Grid tubes to create the desired grid measurements.



6 GRID BRACKET 90°

Clamp two grid tubes together with this bracket to create a solid framework for your grid.

7

6

5

4



4 COVER FOR GRID TUBE

Cover the open ends of the grid tubes with this cover.



5 T-CAP 50X 2,5MM (INSIDE) GRID TUBE

Cover the open ends of the grid tubes with this cover.



FLEXIBLE GRID

Do you need an installation that can be easily moved up and down, eliminating the need to perform equipment adjustments high above the floor?

The Grid system can be installed in a truss construction, and with a simple push of a button, the whole installation can be lowered effortlessly. This type of installation not only speeds up the adjustment of the lighting plan but also significantly improves safety and accessibility to your gear. It eliminates the necessity for adjustments to fixtures and other equipment at heights, a task increasingly subjected to strict safety measures.

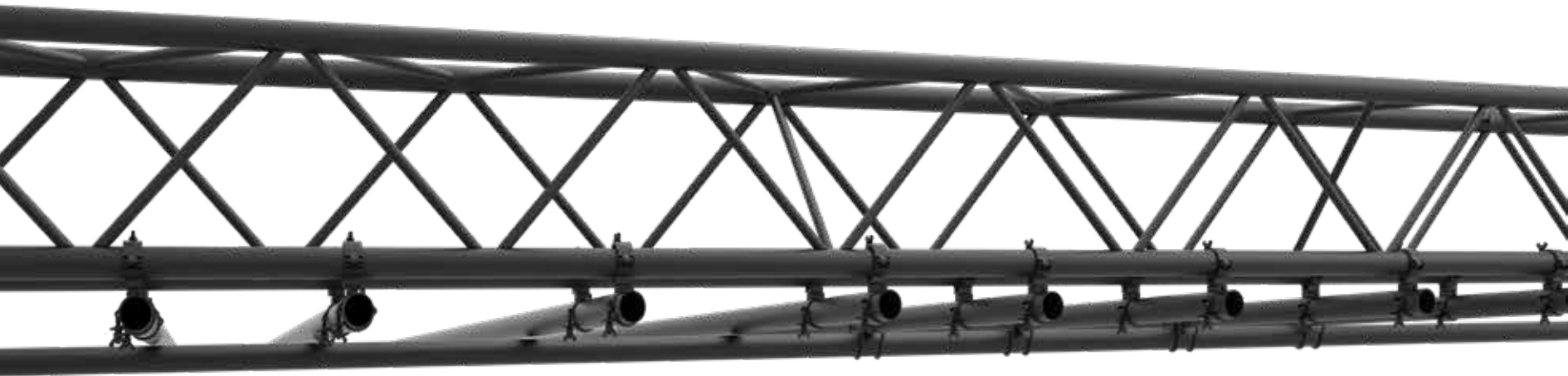

CABLE GUIDES

04

Permanent installations of truss systems require a neat solution to route all the cables of suspended light and audio equipment, especially if the truss has to be raised or lowered regularly. With Admiral's range of Cable Guides, cables of all types and sizes can be neatly and securely fastened to a truss system, allowing it to travel up and down without the risk of knots and loops.

04 CABLE GUIDES

SNAKE® CABLE GUIDE

BASIC® CABLE GUIDE

45

47

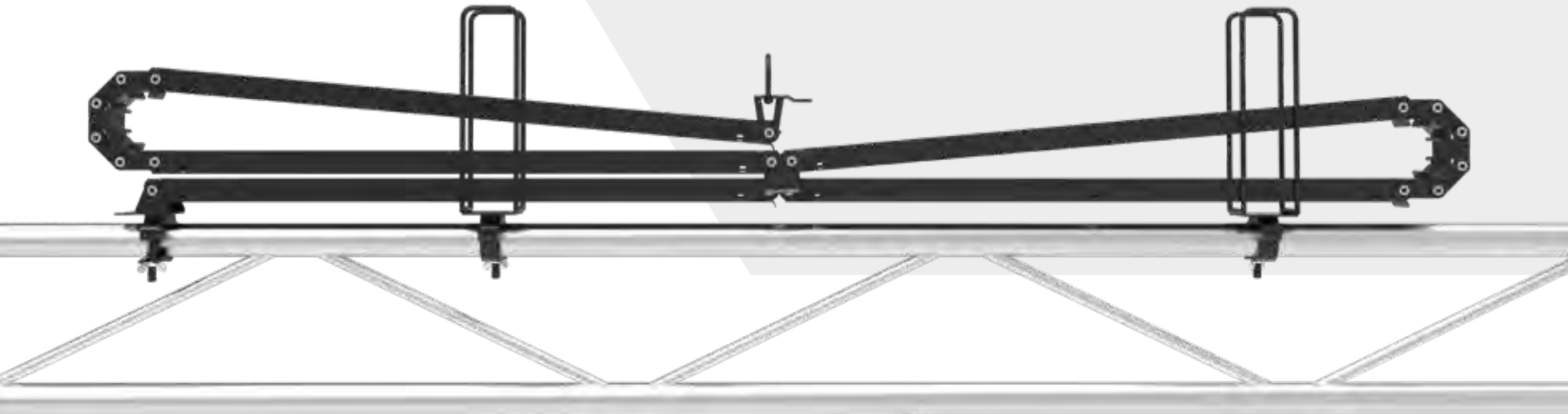



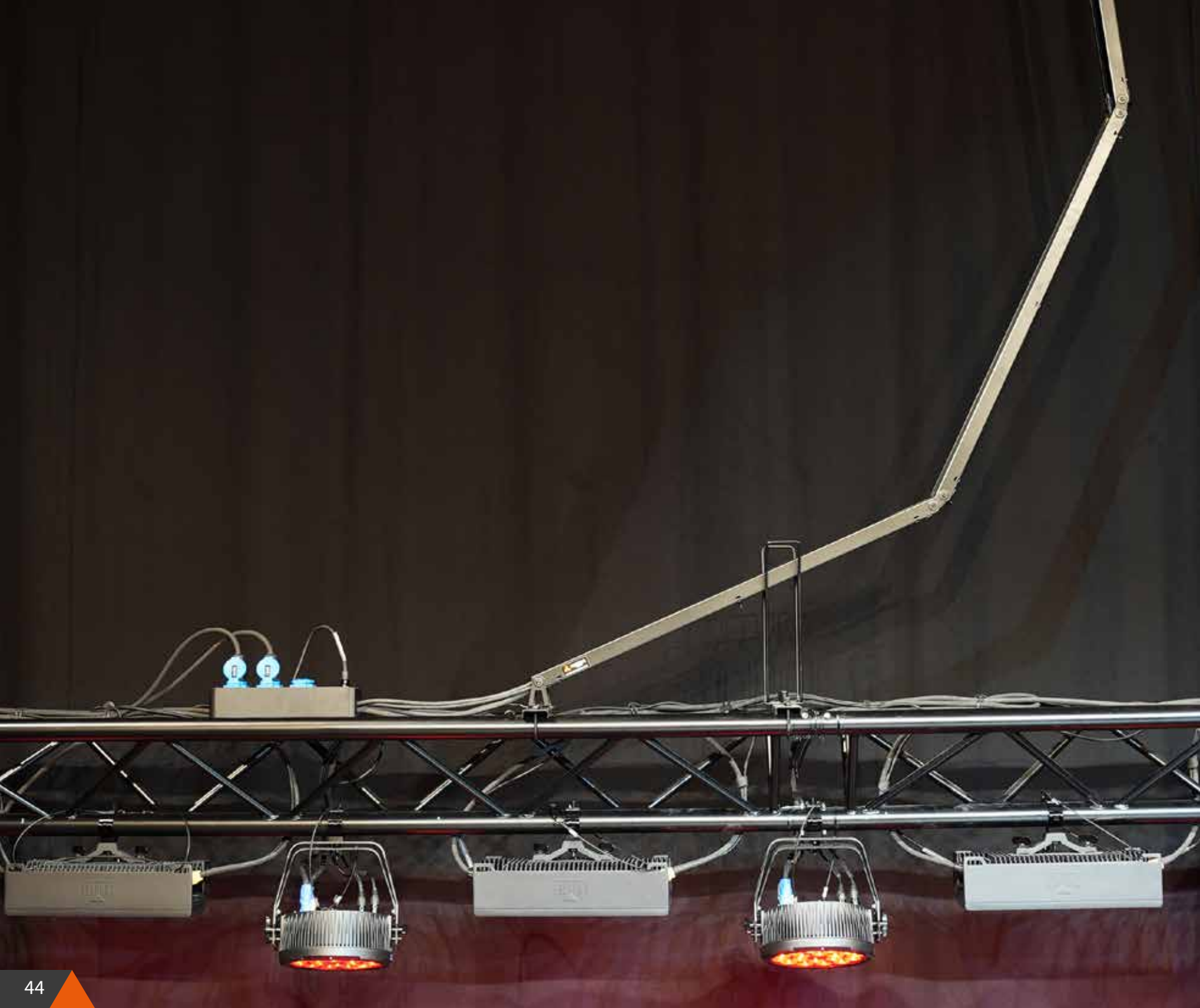

SNAKE[®] CABLE GUIDE

The Snake cable guide is an innovative and versatile cable management solution that can be mounted onto single tubes, ladder - or triangle truss 30 and 40. The Snake features pivoting hinges which ensure the cables are gently bent around a minimum diameter, making the Snake especially well-suited for less resilient cables such as fibre optic ones. The interlocking mechanism of the hinges guarantees minimal lateral movement while hoisting the truss up and down. Different height variations are available in both a silver and black version.

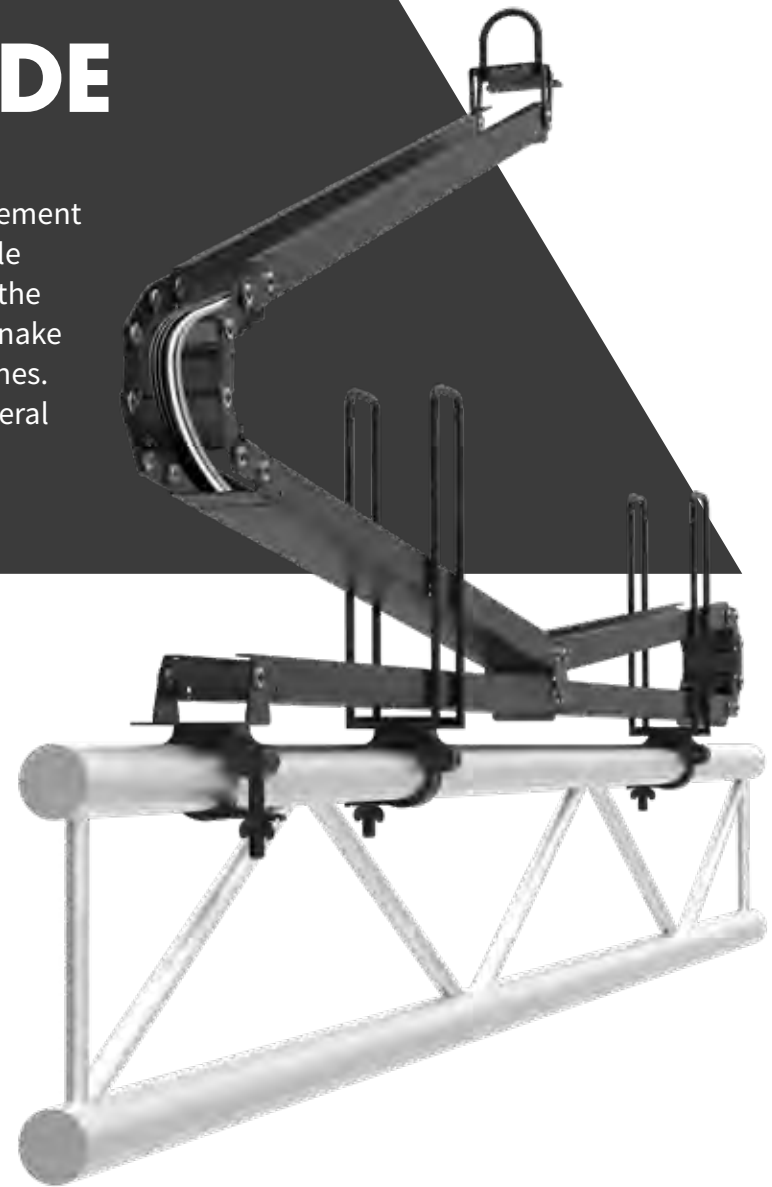

VARIATIONS

2m Base

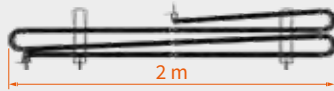

3m Base

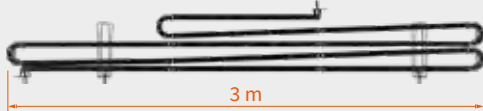

4m Base

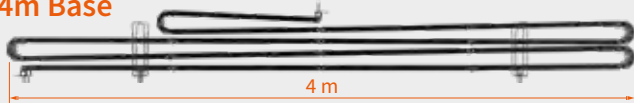

Mount on single tube,
30 and 40 truss

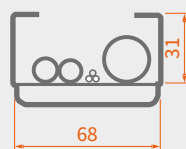

68 mm gutter
for routing your cables

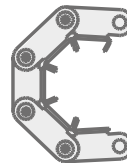

Unique hinges that increase
the bending radius



Minimal lateral
movement

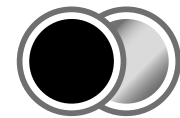

Available
colours



BASIC[®] CABLE GUIDE

Our Basic cable guide is a sturdy and reliable cable management solution for a clean-looking, solid suspension system. This cable guide features a solid design with wide gutters capable of accommodating thicker cables and the bends make it possible to route cables including their connectors. The hinge points are fitted with ball bearings in order to limit wear to a minimum and provide a lifetime of use. The Basic cable guides are made from 2 mm steel and they have a discrete black finish.

© Design registered in the EU.



VARIATIONS

2m Base

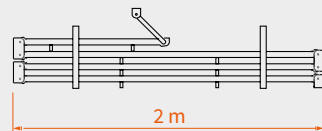

3m Base

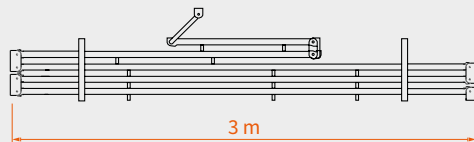

4m Base

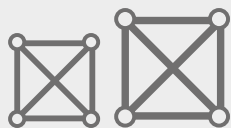
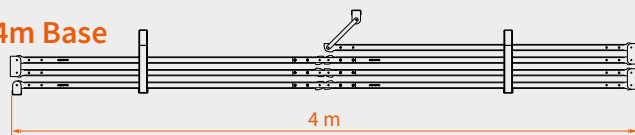

Mount on
30 and 40 truss

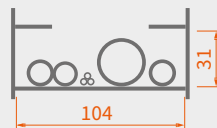

104 mm gutter
for routing your cables



Ball bearing hinges
for a lifetime use



Rigid and
sturdy design



Available
colours



BUILD A RAMP

Always struggling to build a ramp for your stage? Rolling flight cases and other equipment on your stage has never been simpler! With our Admiral Ramp support systems, you can build your ramp in just a few steps. Based on the height of your stage, two or three stage deck pieces can be joined and secured using one of our Ramp support options.

05

05 BUILD A RAMP

FLEX RAMP SYSTEM	50
RAMP SUPPORT SYSTEM®	51
ALL-IN-ONE RAMP SUPPORT®	52
RAMP SLOPE	53





FLEX RAMP SYSTEM

Easily customize stage ramps for various heights using our Flex Ramp system. With three types of Flex components, you can create ramps for stage heights between 40 and 180 cm. Depending on your desired height, the ramp can consist of 2 to 6 decks and span between 4 and 12 meters in length. Scan the QR code to determine which specific Flex Ramp elements to use for your desired ramp height.

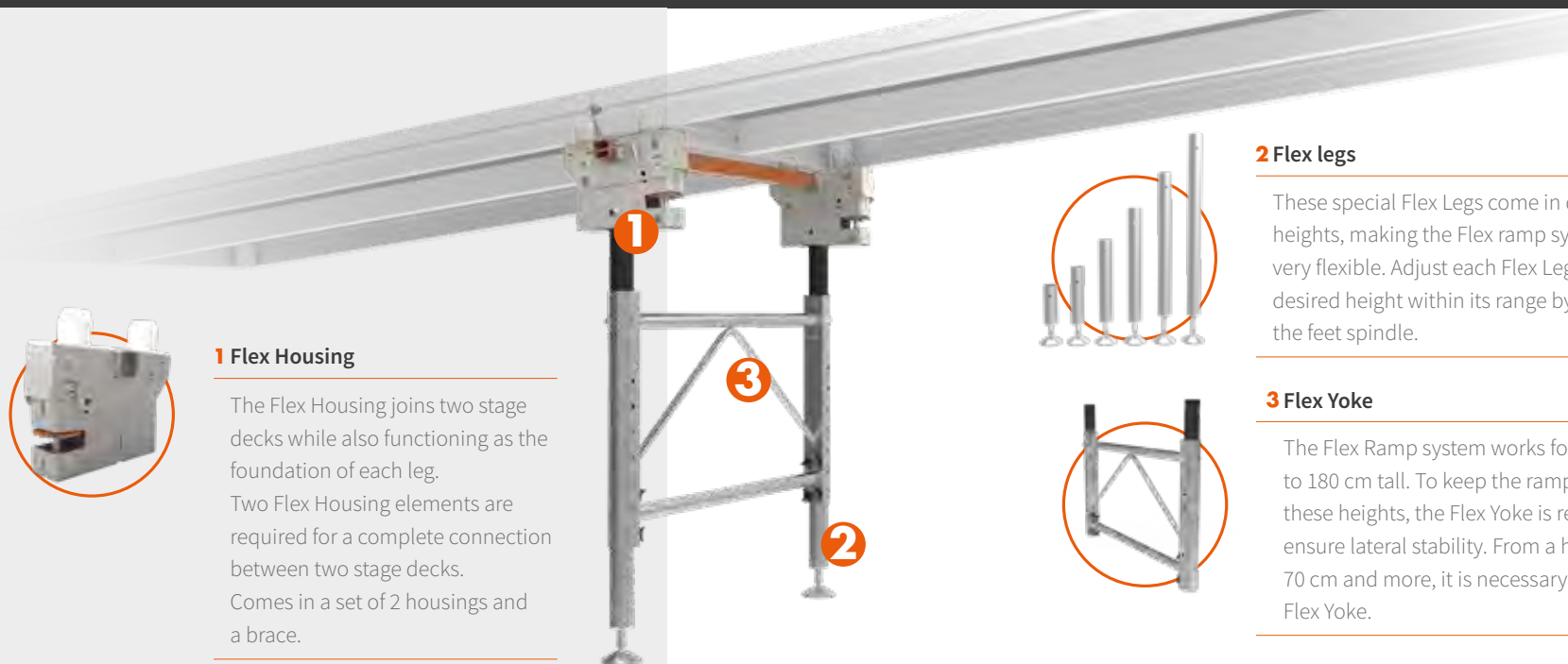

1 Flex Housing

The Flex Housing joins two stage decks while also functioning as the foundation of each leg. Two Flex Housing elements are required for a complete connection between two stage decks. Comes in a set of 2 housings and a brace.



500 kg/m²



NO dynamic loads
such as e.g. cars

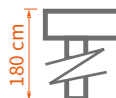

Max stage height

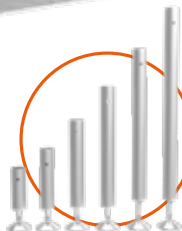

2 Flex legs

These special Flex Legs come in different heights, making the Flex ramp system very flexible. Adjust each Flex Leg to the desired height within its range by turning the feet spindle.



3 Flex Yoke

The Flex Ramp system works for stages up to 180 cm tall. To keep the ramp stable at these heights, the Flex Yoke is required to ensure lateral stability. From a height of 70 cm and more, it is necessary to use a Flex Yoke.



Variable increments

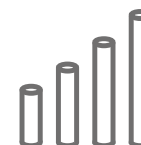

Use Flex legs

RAMP SUPPORT SYSTEM[®]

The ramp support system consists of three different products, the Ramp support fixed, the Ramp support for 2 decks and the Ramp support for 3 decks. Depending on the desired height of the ramp you are trying to build, the ramp will be 4 or 6 meters long. This system is equipped with a unique adjustment feature allowing you to use your standard round stage legs to build ramps from 40 cm up to 140 cm in height.

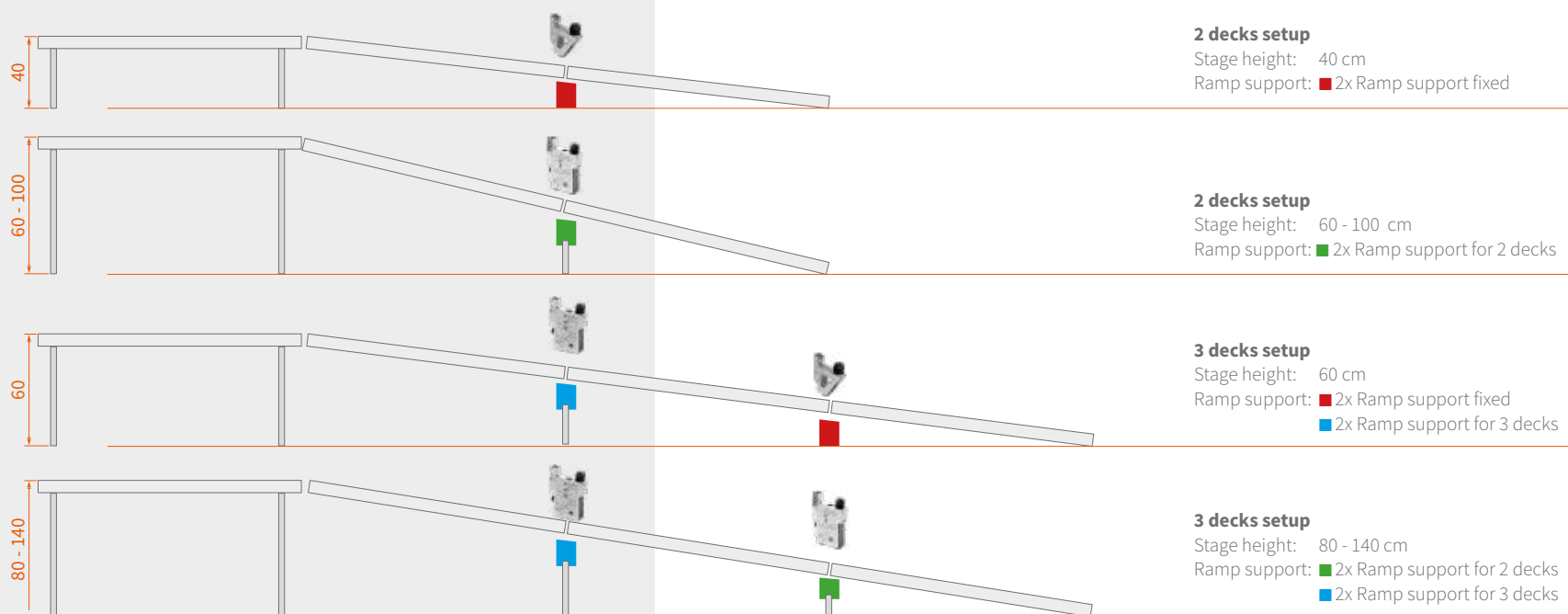

250 kg



NO dynamic loads such as e.g. cars

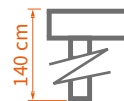

Max stage height

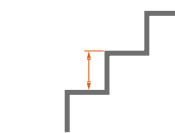

Increment 20 cm

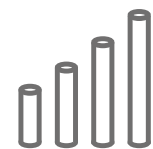

Use standard stage legs

ALL-IN-ONE RAMP SUPPORT[®]

The ALL-IN-ONE ramp support allows you to build a ramp using only one support element. For this Ramp support system you need to use custom-made stage legs cut to the different desired heights. By using the ALL-IN-ONE ramp support in setups of 2 or 3 decks, you can build a ramp with a height of 40 up to 120 cm, with increments of 15 or 20 cm.

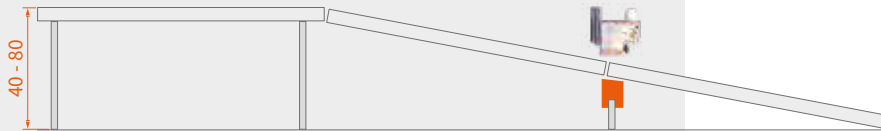

2 decks setup

Stage height: 40 - 80 cm

Required products: ■ 2 x ALL-IN-ONE ramp support

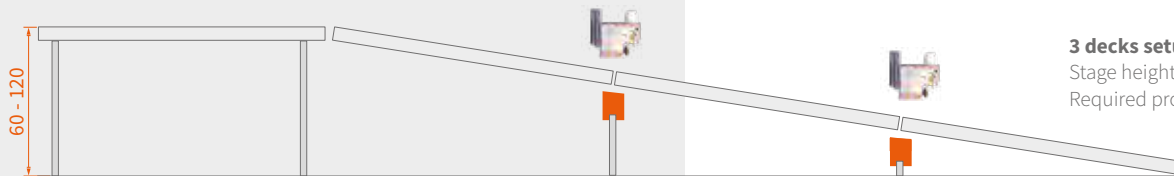

3 decks setup

Stage height: 60 - 120 cm

Required products: ■ 4 x ALL-IN-ONE ramp support



250 kg



NO dynamic loads
such as e.g. cars



Max stage height

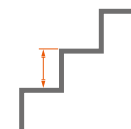

Increment 15/20 cm

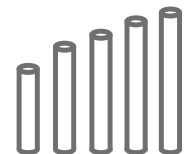

Use custom made legs

RAMP SLOPE

Easily build your perfect ramp using these handy compact ramp attachments. Their small size and lightweight design ensure easy handling. In addition, they hook themselves onto the stage decks for optimal safety. The parts are provided with anti-slip rubber feet and can be linked, if desired, with two M10 screws.

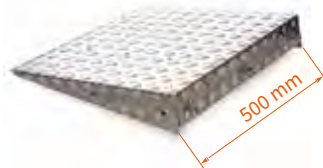
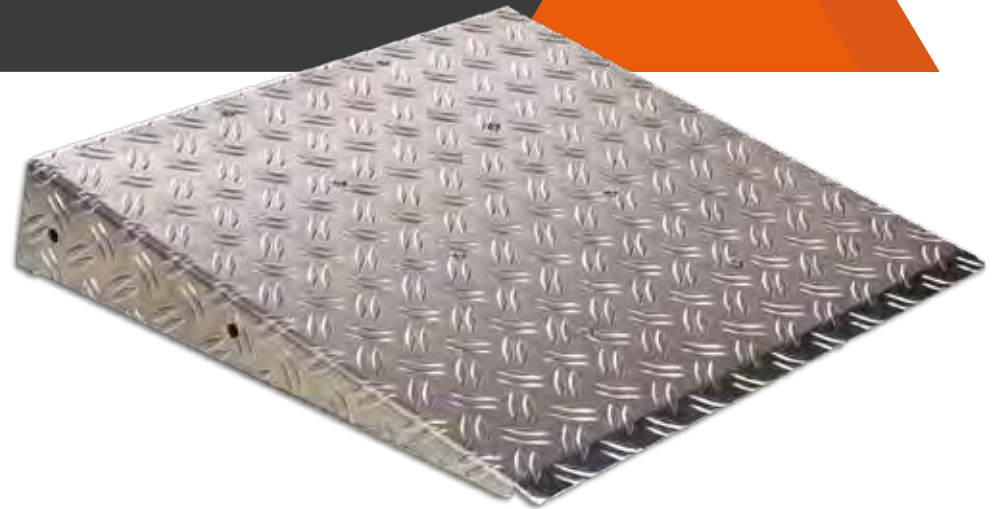
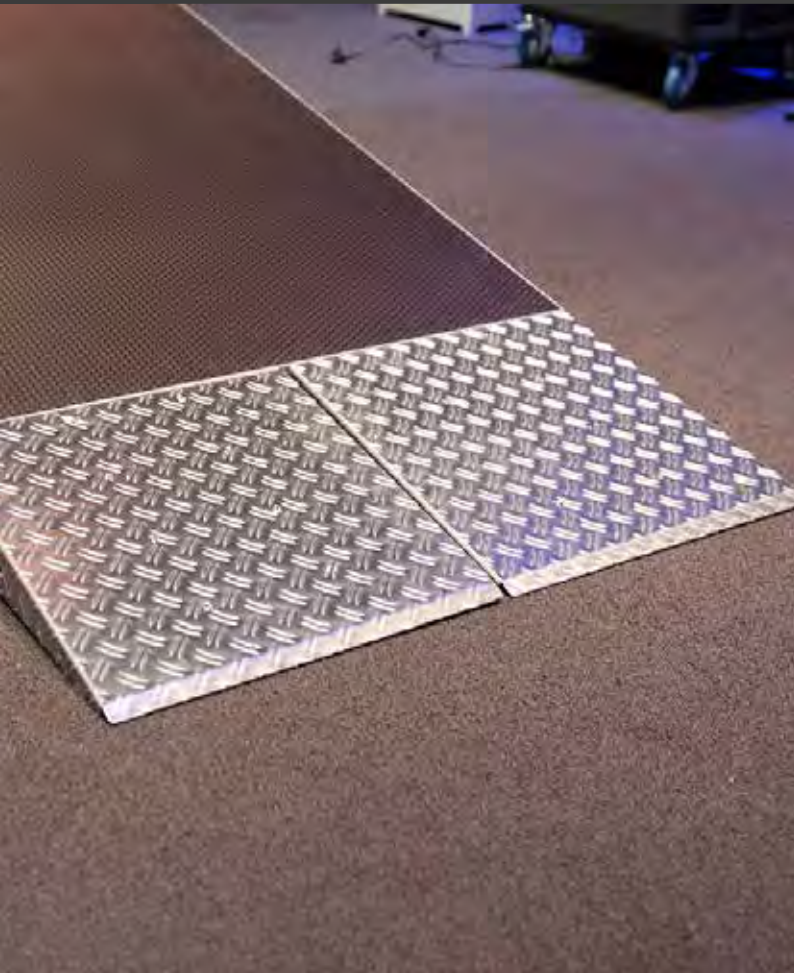

0.5 m parts make it possible to use this slope for every stage deck width.



Hook the slope on to the connecting profile of your stage deck.

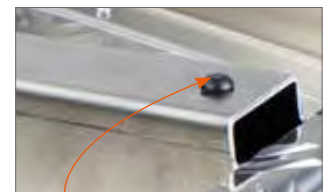

Equipped with rubber feet to prevent it from slipping.

LIGHTING

A successful performance doesn't depend on the band alone. To make your event stand out and captivate your audience, you need to focus on the details.

Our range of lighting products can help you enhance the look and feel of any event space, add visual impact to an area and create the right ambiance.

06



06 LIGHTING

VINTAGE® LUMINAIRES
LUMINAIRE TRIPOD

56
57



VINTAGE[®] LUMINAIRES

An Admiral Staging fixture with a vintage look – because retro chic is absolutely en vogue! You can use these decorative fixtures for your TV shows, theatre productions or for live bands to add visual impact to an area and to create a specific atmosphere. The fixture has a golden reflector finish and two concentric black metal rings to provide that vintage spotlight look. The adjustable brackets allow you to use the Vintage in multiple ways. You can hang it on a Drop arm, mount it on a tripod by using one bracket or you can place it on the floor by using both. You can also interlink several Vintage luminaires using their sturdy brackets.

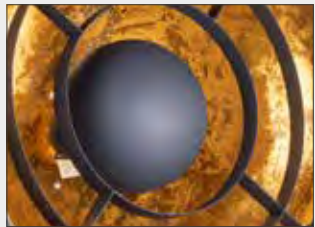

Reflective shell



Seetronic true1 connector



Sturdy, adjustable bracket



Interlinkable



Fitting E27
60W (bulb included)



Available diameters:
Ø 380 mm & Ø 530 mm

LUMINAIRE TRIPOD

Complete your setup by extending the luminaires with the help of our luminaire tripod. The tripod has a standard length of approximately 1 meter and can be further extended to 1.55 meters with an extension set.



Extension set available to increase the tripod height to 1.55 meters. Only suitable for static lights.



10 kg

TRUSS ACCESSORIES

The use of aluminium truss systems as both a decorative and functional application has spread from its customary role in temporary event productions, into a wide range of commercial installations. At Admiral Staging you can find truss accessories for lifting and mounting your truss as well as baseplates to support your truss construction.

07



07 TRUSS ACCESSORIES

BASEPLATES	60
- ACCESSORIES	61
TRUSS CARRIER	62
THE BRICK®	64
TRUSS TOPPER / FLOOR STAND	65
TRUSS BRACKET	66
MOUNTING BRACKET	67



BASEPLATES

Our steel baseplates can be mounted at the bottom of your standing truss structure, providing you with a solid and stable base. Adding 25 kg of weight to the bottom of your truss construction, they are an excellent base for free-standing objects. Pre-drilled symmetrical and asymmetrical holes, suitable for the attachment of M12 conical couplers, make assembly and mounting quick and easy. Attaching your truss with M10 couplers can also be easily done by using our reduction ring.



Countersunk holes



Conical coupler



Easy to handle

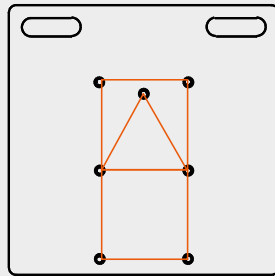

Baseplate for 30 truss

30 truss centre-to-centre distance 229 mm

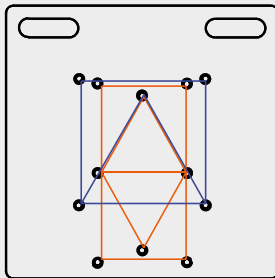

Combi baseplate 30 and 40 truss

30 truss centre-to-centre distance 229 mm

40 truss centre-to-centre distance 329 mm



Asymmetrical

30 truss square or triangle placement against a wall

Symmetrical

30 or 40 truss square or triangle positioned centrally



Weight 25 kg



730 x 730 x 6 mm
(L x B x H)



for both triangle and square truss

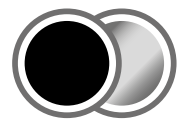

Available colours

ACCESSORIES



Mono Stand

The Mono stand can be used to install equipment vertically from the ground, saving space in areas where a tripod is not an option. Mount it easily onto a baseplate with an M12 bolt and secure tubes or profiles with butterfly bolts. It supports tubes and profiles with diameters of 38-55mm, with a 25 kg work load limit for fixtures, cameras, decorations and more. Its compact design allows for multiple Mono Stands to be installed on one baseplate.



Baseplate floor protector

Apply this adhesive rubber mat underneath your baseplates for both floor protection as well as more friction.



Baseplate reduction ring

Never switch between M10 and M12 bolts ever again with this handy reduction ring.



TRUSS CARRIER

Transport your truss safely and efficiently with our strong, solid and anti-slip rubber truss carriers. These carriers are equipped with rubber studs moulded around the inner aluminium tube, which help the truss stack together easily and with improved stability. Available in two variations, for 30 truss, either triangle or square, and for 40 square truss.



STRONG BOY CARRIER®

Design registered in the EU/UK.

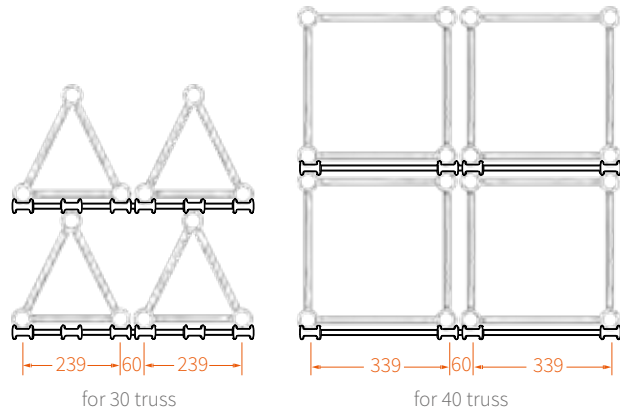
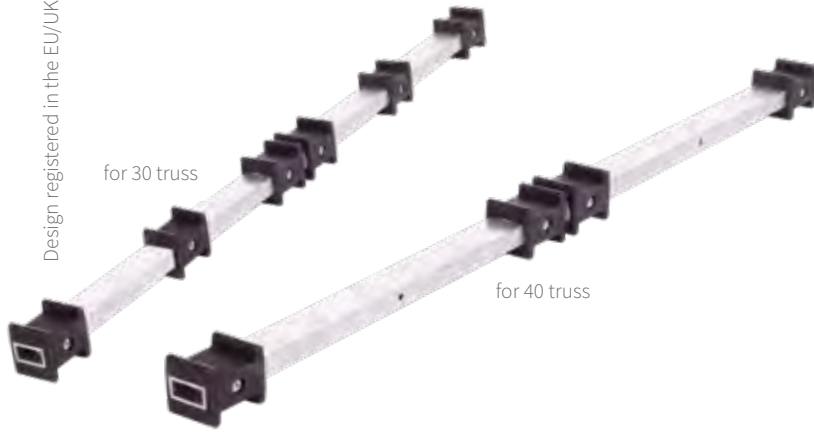

STRONG GIRL CARRIER

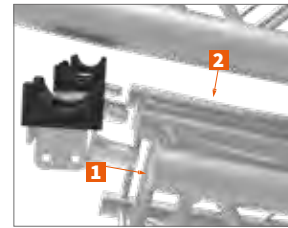
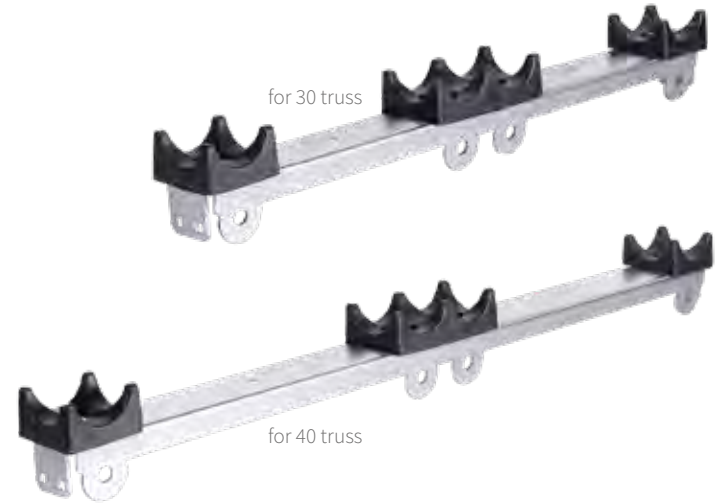

To stack, assemble the carriers with a conical coupler to the truss

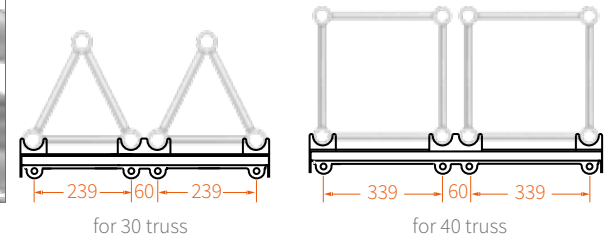

SINGLE RUBBER STUD®

With our single rubber studs, you are no longer limited to the standard truss carrier dimensions. These allow you to customse your own truss carrier, with dimensions fit for any truss you'd like to transport. The aluminium profiles are not provided, but they are available separately.

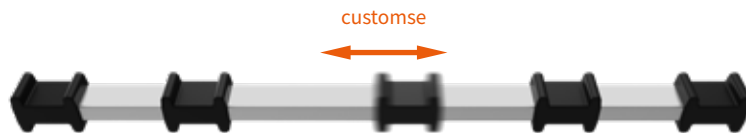

Single rubber stud

Aluminium profile

Design registered in the EU/UK.

THE BRICK[®]

Stack your truss fast and easy with The Brick.

Made of strong and lightweight rubber, The Brick protects both the truss and ground from scratches during installation and stacking of truss. By using a cable tie, you can fasten The Brick permanently to your truss. This ensures that you can stack truss immediately for storage and transportation. The Brick is suitable for truss with a tube diameter between 48 – 52 mm.



Always secure The Brick with a cable tie.



TRUSS TOPPER FLOOR STAND

The Admiral Truss topper/Floor stand is again a game changer. It is stackable, anti-slip and usable in different ways. With an ELL of 100 kg and the round tube for theatre hooks and half-couplers, it can be mounted on top or underneath your 30-truss to add fixtures or other equipment. Giving you a temporary or permanent solution while doing your job. It can also be used as Floor stand, thanks to the anti-slip rubbers. This will give you more lighting options during your event.

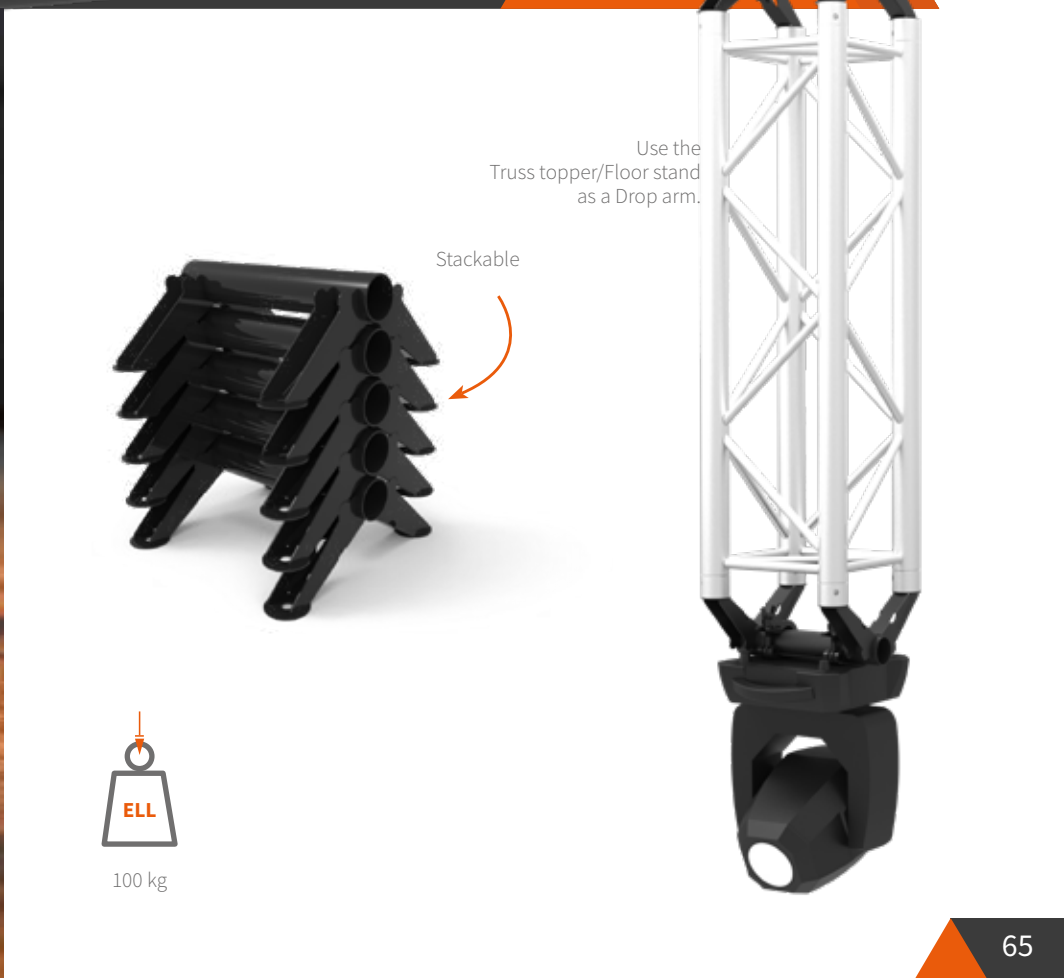

TRUSS BRACKET

Our truss brackets are ideal to use when truss constructions have to be lifted or suspended by means of a motor or chain hoist. They can be used with truss 30 and have a maximum lifting weight of 500 kg.



permanent installation
with U-bolts



temporary installation
with half couplers



500 kg

MOUNTING BRACKET

Our mounting bracket is the ideal solution for hanging your truss 30 from the ceiling in a fixed installation. The bracket is attached with wire clamps to the truss girders and can be secured to the ceiling with either one or two threaded rods.

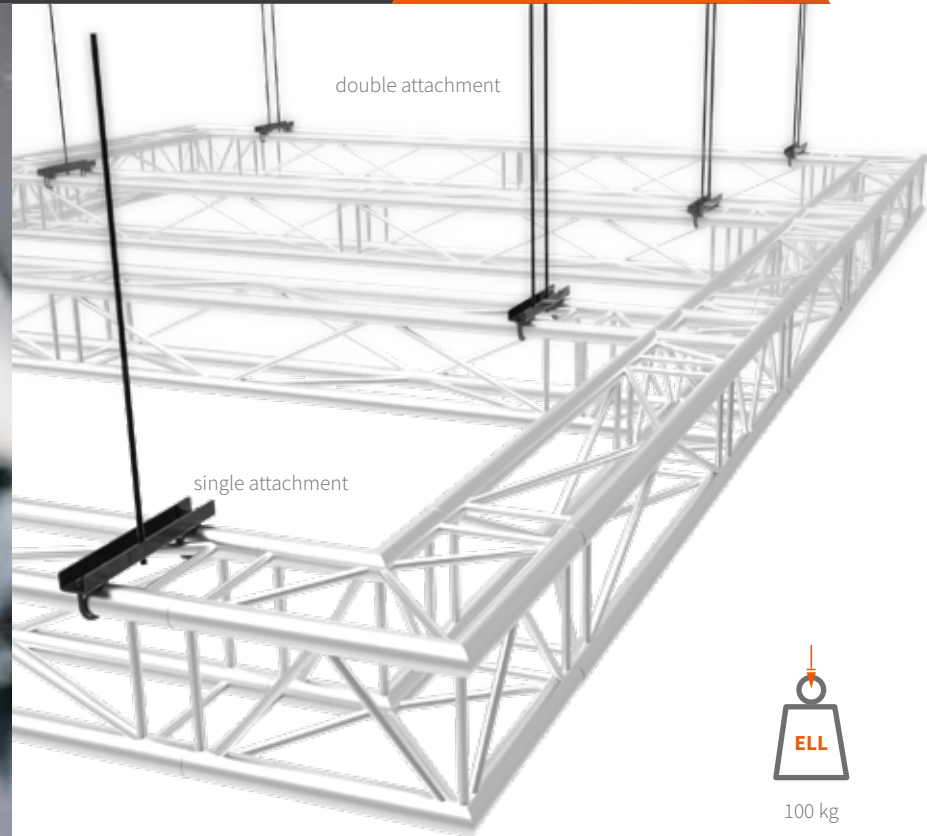

CLAMPS & SAFETIES

08

Admiral aims to offer a complete product range from which essentials such as clamps and couplers cannot miss. Regardless of what type of equipment you need to rig, our range includes everything from TÜV certified couplers with a weight load limit up to 750 kg to BGV-C1 certified safety cables and more.



08 CLAMPS & SAFETIES

SHARK® KEDER CLAMP

SAFETY CABLES

CLAMPS & COUPLERS

70

71

72



SHARK[®] KEDER CLAMP

The Shark is a TÜV certified tent clamp designed for quickly and easily installing equipment onto keder profiles. It can be used to create a hanging point on tent profiles, where no other attachment is possible. The Shark accommodates beams from 50mm up to 125mm and it can be quickly adjusted for different widths thanks to its spring loaded clamp. With its constant entertainment load limit of 200 kg, this clamp ensures a secure and reliable installation of your equipment, even for heavier loads such as hoists and truss. The design of the clamp ensures the load is always centric, regardless of the width of the profile.



TÜV certification

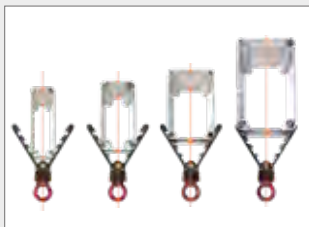

Centric load at all times

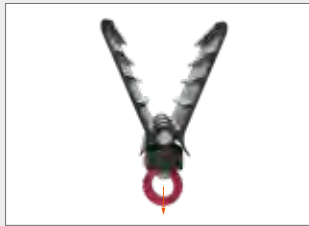

Constant load limit



Quick assembly onto differently sized beams



Constant load limit



For detailed instructions and information, please refer to the product manual.

SAFETY CABLES

Use certified safety cables to ensure the safety of your crowd!

When hanging staging equipment above a crowd of people you need to use an independent, secondary safety-device according to BGV-C1 and VGB regulations. Our range includes BGV-C1 certified safety cables, available both in a galvanised and black finish, that can be used single or double stranded. Mount your Admiral safety cables in a loop and as short as possible so that, if equipment falls, the safety cable is in the best position to absorb the weight.



Available
colours



3 diameters
3, 5 and 6 mm



lengths
60 and 100 cm

CLAMPS & COUPLERS

Admiral offers an extensive selection of clamps and couplers, ranging from aluminium Half couplers to Swivel couplers that can support a Working Load Limit of up to 750 kg. Our renowned G- and C-Clamps are also part of our product range. These clamps come equipped with a spring steel protector that safeguards your truss against damage while mounting them.



The Admiral Qwiqr is the next generation sliding connector for clamps. We do have a very good reason to name this item Qwiqr. Because this clamp is quick. Slide the hook into the housing and click!

© Design registered in the EU



50 kg



C-CLAMP

Ø 48-51 mm



G-CLAMP

Ø 48-51 mm



QUICK

Ø 48-51 mm



SWIVEL

Ø 48-51 mm



SELFLOCK

Ø 48-51 mm



HALF COUPLERS

Ø 18-21 mm



Ø 32-35 mm



Ø 48-51 mm



Ø 58-61 mm



Ø 48-51 mm



Ø 32-35 mm

Half coupler with half cone



Ø 48-51 mm

Half coupler with spigot mount



 All our couplers
are TÜV certified.



09 TEXTILES

Decorate your stage and create a scene with no distraction with one of the options in our textiles range. From stage skirting rolls such as our Deco Molton and Velcro stage-polyester to our heavy-duty Backdrops and Sound absorbing backdrops, at Admiral you can find all the textile essentials you need to create the desired atmosphere for your stage.

09



09 TEXTILES

BACKDROPS	76
SOUND ABSORBING BACKDROPS	77
DECO MOLTON	78
HOOK AND LOOP STAGE POLYESTER	79
TRUSS COVERS	80





BACKDROPS

Backdrops play an essential role in creating the right mood and setting for your performance, so we made sure ours are the perfect quality. They are stronger than most backdrops on the market, but still a lighter weight, which makes this fabric wrinkle a lot less. Made out of high quality flame-retardant material, the Admiral backdrops are available in multiple widths and lengths. They are conveniently equipped with pre-assembled eyelets every 25 cm, making them easy to mount.



Available colours



Flame retardant



Available widths
3 and 6 m
Available heights
3, 3.5, 4, 4.5, 5 and 6 m

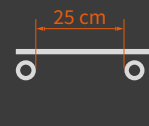

Pre-assembled eyelets
25 cm



Made of Oekotex,
GRS recycled cotton



SOUND ABSORBING BACKDROPS

Reduce the amount of external noise in your studio or practice room and improve the internal acoustics with the help of our soundproof curtains. They are a simple and cost-effective solution for dampening sound and can be easily fitted and installed in every space. The Admiral Sound absorbing backdrops are made of high quality, fire retardant fabric weighting 500g/ m². They are equipped with pre-assembled eyelets every 25 cm, making them very easy to mount.



Available colours



Flame retardant



Width 3 m
Available heights
3, 4 and 5 m

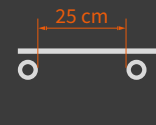

Pre-assembled eyelets
25 cm



Made of Oekotex,
GRS recycled cotton

DECO MOLTON

The Admiral Deco Molton is a cost-effective solution for putting the finishing touch on a portable or permanent stage, riser or platform and giving it a clean, finished look. Made out of 100% cotton, this fabric is smooth and has a slight shine on both of its sides. This skirting is available in both black and white and it comes in various heights, from 20 cm up to 140 cm. Each roll is 60 meters long and is supplied with three rolls of double-sided tape to attach the Deco molton to your stage decks.

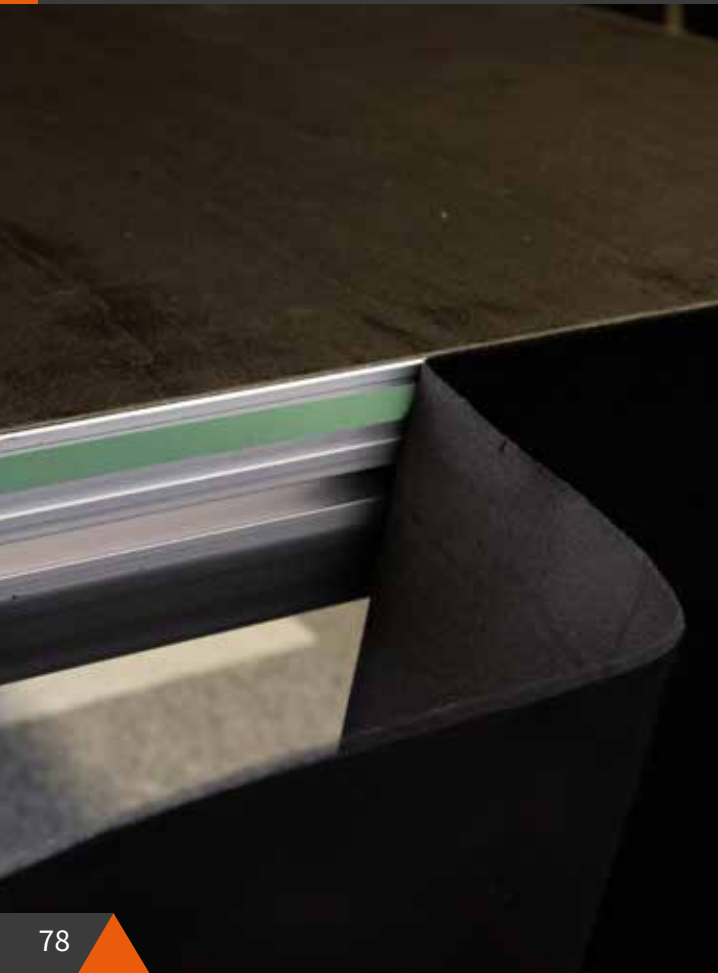

Roll your Deco Molton with minimal effort using our Jack the gripper



Available colours



Flame retardant



Available in heights
20, 40, 60, 80, 100, 120, 130, 140 cm

HOOK AND LOOP STAGE POLYESTER

Our Hook and loop stage polyester is a versatile, self-attaching polyester fabric that can be used to dress up your stage and hide any understructure that might be distracting. One side of this flame retardant fabric, the back, consists entirely of the loop side of velcro, whereas the front of the fabric is smooth and slightly shiny. Because the fabric is knitted, it can be cut to size without running the risk of fraying, and it can be reused several times without the loss of quality. This skirting is available in black and comes in rolls of 25 meters. Various heights are available, ranging from 20 cm up to 100 cm.



Available
colours



Flame retardant



Available in heights
20, 40, 60, 80 and 100 cm



TRUSS COVERS

With our Truss covers, you can easily conceal all the cables surrounding your truss, giving your setup a neat appearance, or you can add a vibrant pop of colour. Adapting perfectly to the shape of your truss, these covers provide a sleek look to any triangle or square truss 30.



Easy to customise by cutting them to length.



Our truss covers are certified as flame retardant. Because the yarn itself has fire retardant properties, the fabric retains its protective qualities even after washing it, making these covers a reliable long-term solution for your setup.

Available in three standard heights as well as in a 30 m option, which allows you to customise and cut the truss covers to your desired length.



Available colours



Flame retardant even after washing



Available in heights 100, 200, 300 and 3000 cm



Made of 85% Polyester FR and 15% Elasthane

CABLES & CONNECTORS

10

At Admiral Staging you can find a complete range of cables, connectors and cable management accessories. Our pre-assembled DMX cables and heavy-duty extension cables are a cost-effective solution available in a variety of types and lengths. Our clever cable management solutions, such as the colourful cable wraps or T-fix rubber bands, help you manage your cables quickly and easily!

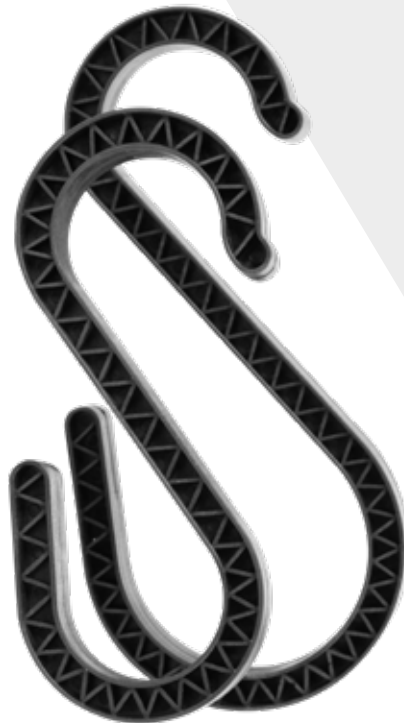

10 CABLES & CONNECTORS

DMX CABLES	84
EXTENSION CABLES	85
CABLE PROTECTOR	86
CABLE WRAPS	87
CABLE HOOKS	88
T-FIX	89



DMX CABLES

Whether you're lighting a stage, theatre or live concert, our 3-pin and 5-pin DMX cables can provide you with the strongest and most reliable DMX signal. The sturdy metal connectors allow the cables to be easily plugged in and unplugged while also ensuring a reliable connection. Thanks to the PVC jacket, the DMX cables can be quickly rolled up for easy storage between the shows.

DMX Cables

Our good quality, cost-effective DMX cables come equipped with a shrink wrap sleeve for easy labeling and identification.



Lengths available 0.5, 1, 1.5, 2, 2.5, 3, 5, 10, 15 and 20 m

XLR Chassis and Connectors

Assemble your own DMX cables in no time with our 3- and 5-pin chassis and connectors.



CONNECTORS



3 pins

5 pins

CHASSIS



3 pins

5 pins

DMX adapter cable

Switch with ease from 3 to 5 pins and vice versa. Equipped with a coloured band for easy identification. The blue colour indicates 3 to 5 pin and the red colour indicates 5 to 3 pin.



CONNECTORS



3 pins

5 pins

EXTENSION CABLES

Extend your power wherever you need it with our heavy-duty IP44 extension cables. These come in several variations, assembled with Schuko connectors, with a cross section of 1.5 mm² or 2.5 mm².

Thanks to their durable neoprene outer isolation, these cables are suitable for use either indoor, outdoor or for industrial use. They are equipped with a lid that protects them from foreign objects and splashes of water.

Equipped with a heat shrink sleeve, which allows for quick branding and labeling.



Schuko

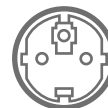

Schuko connector



Lengths available
2.5, 5, 10 and 15 m

CABLE PROTECTOR

Get the vast amount of cables to your FOH on big events with the help of our cable bridges. Designed for use in high traffic areas, these cable protectors prevent your cables from being run over by people or vehicles while also protecting against trip hazards. Our range includes both solid rubber bridges as well as a Polyurethane (PU) version.



Sturdy construction



Easy to connect



2 channels

5 channels

Choose from 2 or 5 channels



Slip-resistant surface

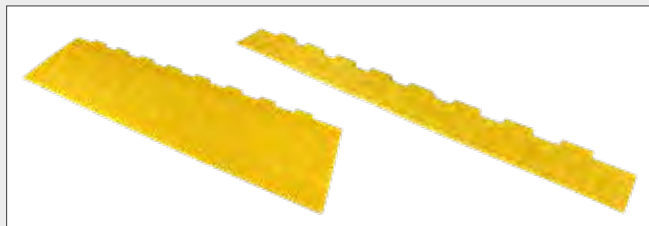

Separate lids are also available



CABLE WRAPS

The Admiral Cable wraps are a simple, efficient and versatile way to keep all of your cables neatly bundled together. Multiple colours are available, making it easier to colour-code.



Lengths available
17, 26, 38 and 55 cm



Available colours



CABLE HOOKS

Running your cables alongside a tube or truss can also be done in no time with our Cable hooks. Taping or binding the cables becomes redundant, making these hooks a time saver.



15 kg



Flame retardant

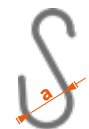

2 sizes available
a = 50 mm
a = 80 mm

T-FIX

Our T-fix is a strong and reusable rubber band which can be used to quickly fasten your cables to a truss or fly system. These rubber bands are provided with a hook in order to swiftly close the loop.



Lengths available
4, 6, 8, 16 and 23 cm

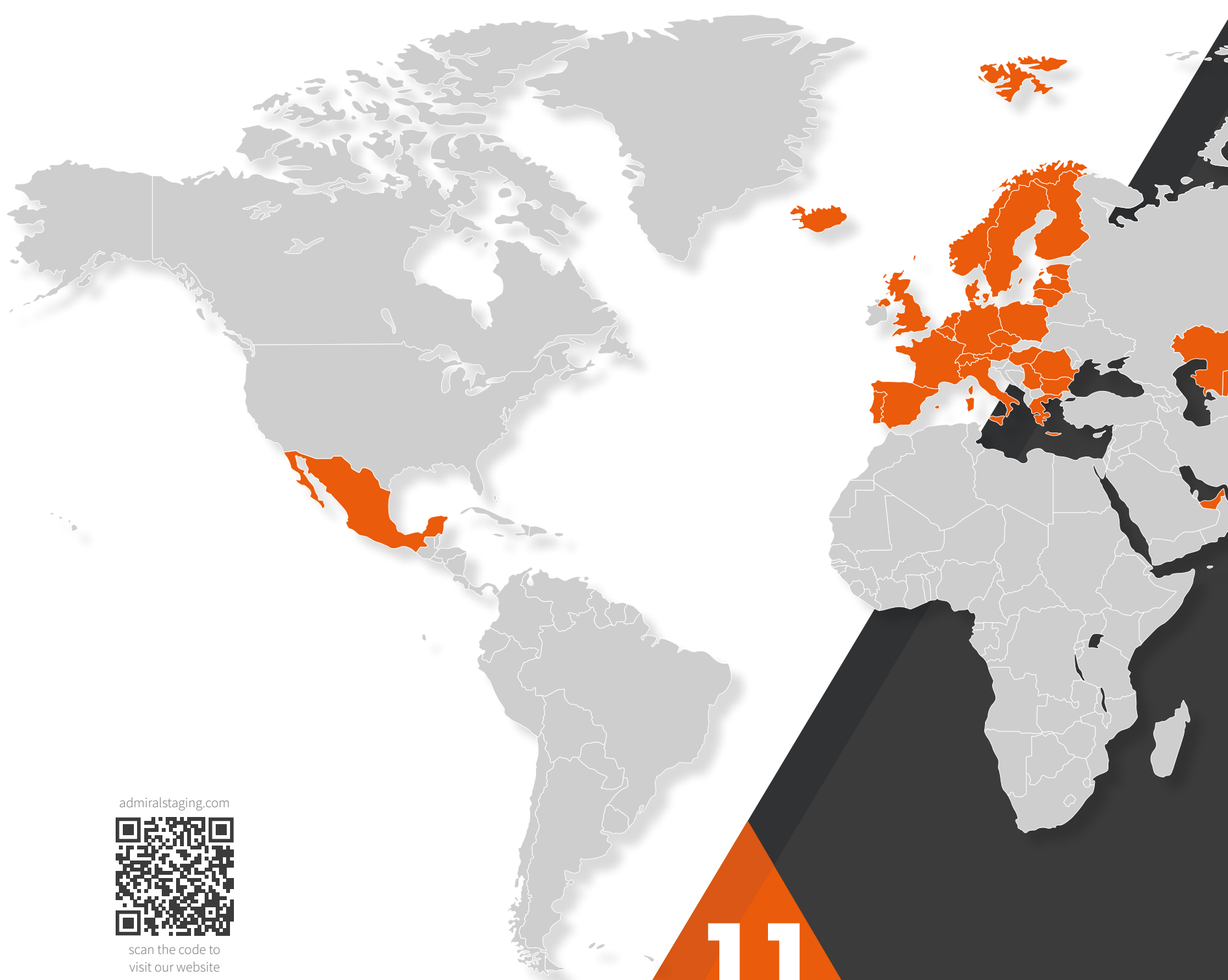

admiralstaging.com







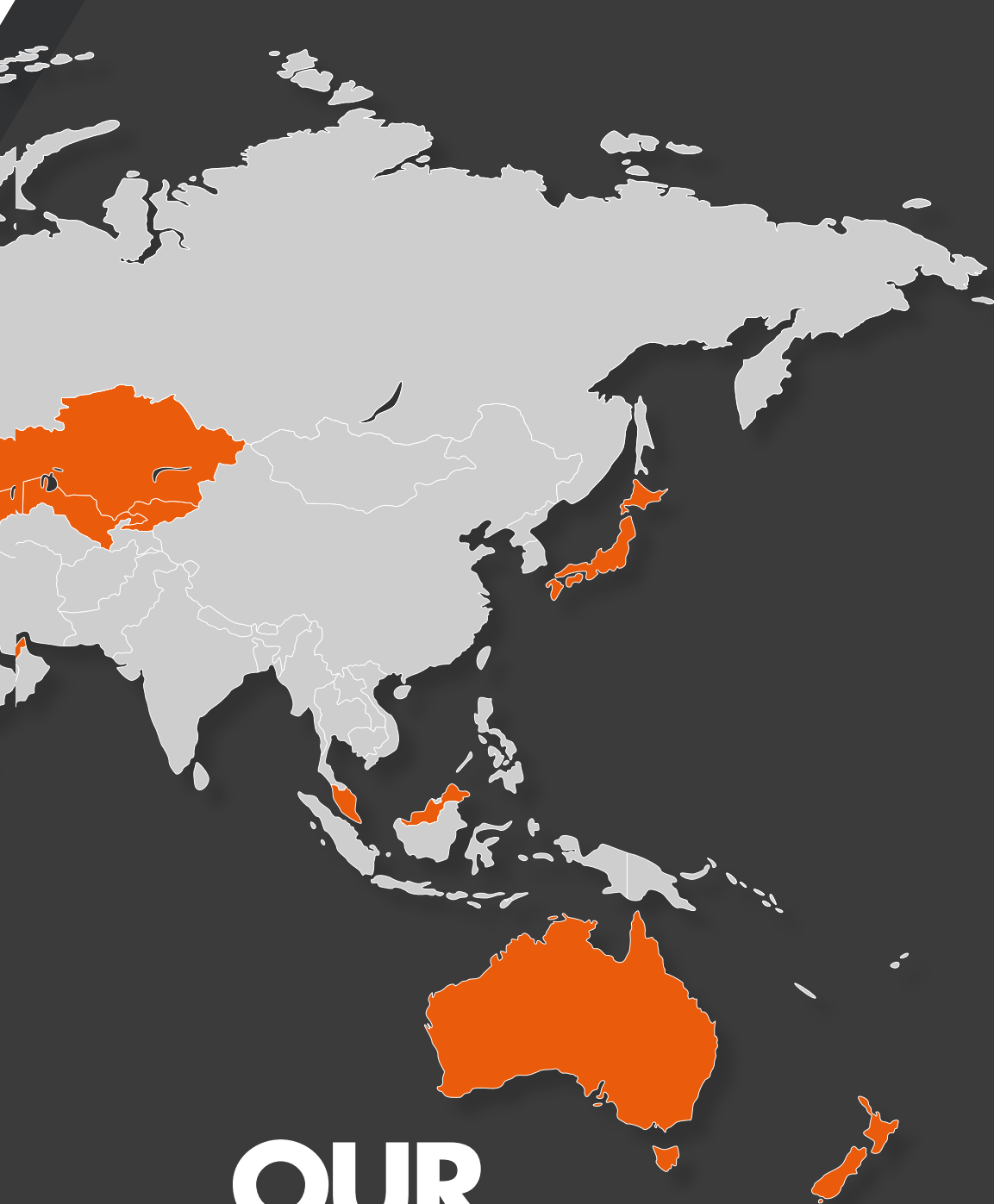











scan the code to
visit our website

11



OUR DISTRIBUTORS

	Australia	Theatre Safe Australia
	Austria	RTC Fürstler Sound & Light
	Belgium	Bekafun
	Bulgaria	Dinakord Bulgaria ltd
	Czechia	LightNeq
	Denmark	Matrix Sales
	Estonia	Progear OÜ
	Finland	Electro Waves Oy
	France	Axente
	Germany	Huss, Licht & Ton
	Germany	Licht Produktiv
	Germany	LTT Group
	Germany	Werning Theatertechnik
	Greece	Audio & Vision
	Hungary	D.P. Music
	Iceland	Atendi
	Italy	Audiosales
	Japan	Sixty 82 Japan
	Kazakhstan	Central Asia Stage
	Kyrgyzstan	Central Asia Stage
	Latvia	Progear OÜ
	Lithuania	Progear OÜ
	Malaysia	Sixty82 Doughty Asia Pacific
	Mexico	Gonher Distribuidora
	Netherlands	Rolight
	New Zealand	Showtechnix
	Norway	Prostage
	Norway	Multitechnic
	Poland	Prolight
	Portugal	Luzeiro
	Romania	eXpert Music
	Serbia	PSP Elektronik
	Spain	Siluj
	Spain	Stonex Show Lighting
	Sweden	Bellalite
	Switzerland	Cast Switzerland
	United Arab Emirates	Provision AVL Gen Trading LLC
	United Kingdom	Stage Electrics
	Uzbekistan	Central Asia Stage

DIDN'T KNOW YOU NEEDED IT



Josink Kolkweg 10
7545 PR Enschede
Tel: +31 53 4 301 201
www.admiralstaging.com
info@admiralstaging.com
