

# ART 932-A

## PROFESSIONAL ACTIVE SPEAKER

### DESCRIPTION

ART 932-A is masterfully engineered to deliver stellar audio performance and versatility for intensive audio applications.

The combination of a 3" titanium/neodymium compression driver, 12" woofer - two-channel 2100W amplifier, and the constant directivity True Resistive Waveguide produces coherent 100° x 60° coverage for the listening area with up to 132 dB SPL, distortion-free sound.

Used as a stand-alone speaker for a FOH system, satellite (with subwoofer), stage monitor, or flown, the ART 932-A packs high-performance and reliability in a compact enclosure. Designed to be the most flexible loudspeaker in its class, it also features multiple rigging points for fixed installation. Merging RCF proprietary FiRPHASE and Bass Motion Control DSP processing, perfectly tuned for each model, the audience will experience absolute clarity and deep, powerful bass response.

The sleek cabinet uses a special polypropylene composite material with an M-brace internal reinforcement, making it easy



### FEATURES

- Up to 132 dB Sound Pressure Level
- 2100W Class-D Bi-Amplification
- 45-20000 Hz linear frequency response
- 3" Titanium/Neodymium Compression Driver
- 12" Woofer
- FiRPHASE zero degrees phase technology
- Bass Motion Control woofer excursion management

## TECHNICAL SPECIFICATIONS

<b>Acoustical specifications</b>	Frequency Response:	50 Hz ÷ 20000 Hz
	Max SPL @ 1m:	132 dB
	Horizontal coverage angle:	100°
	Vertical coverage angle:	60°
<b>Transducers</b>	Compression Driver:	1 x 1.4" neo, 3.0" v.c
	Woofers:	12", 2.5" v.c
<b>Input/Output section</b>	Input signal:	bal/unbal
	Input connectors:	XLR, Jack
	Output connectors:	XLR
	Input sensitivity:	-2 dBu/+4 dBu
<b>Processor section</b>	Crossover Frequencies:	700Hz
	Protections:	Thermal, RMS
	Limiter:	Soft Limiter
	Controls:	Linear, Boost, Stage, Volume
<b>Power section</b>	Total Power:	2100 W Peak
	High frequencies:	700 W Peak
	Low frequencies:	1400 W Peak
	Cooling:	Convection
	Connections:	VDE
<b>Standard compliance</b>	CE marking:	Yes
<b>Physical specifications</b>	Cabinet/Case Material:	PP Composite
	Hardware:	1 x M10 Top, 1 x M10 each side
	Handles:	1 Top , 1 each side
	Pole mount/Cap:	Yes
	Grille:	Steel
	Color:	Black
<b>Size</b>	Height:	642 mm / 25.28 inches
	Width:	370 mm / 14.57 inches
	Depth:	363 mm / 14.29 inches
	Weight:	18.8 kg / 41.45 lbs
<b>Shipping informations</b>	Package Height:	685 mm / 26.97 inches
	Package Width:	430 mm / 16.93 inches
	Package Depth:	423 mm / 16.65 inches
	Package Weight:	21 kg / 46.3 lbs



**PART NUMBER**

- **13000681**  
ART 932-A  
115V  
EAN 8024530019266

- **13000680**  
ART 932-A  
220-240V  
EAN 8024530019112

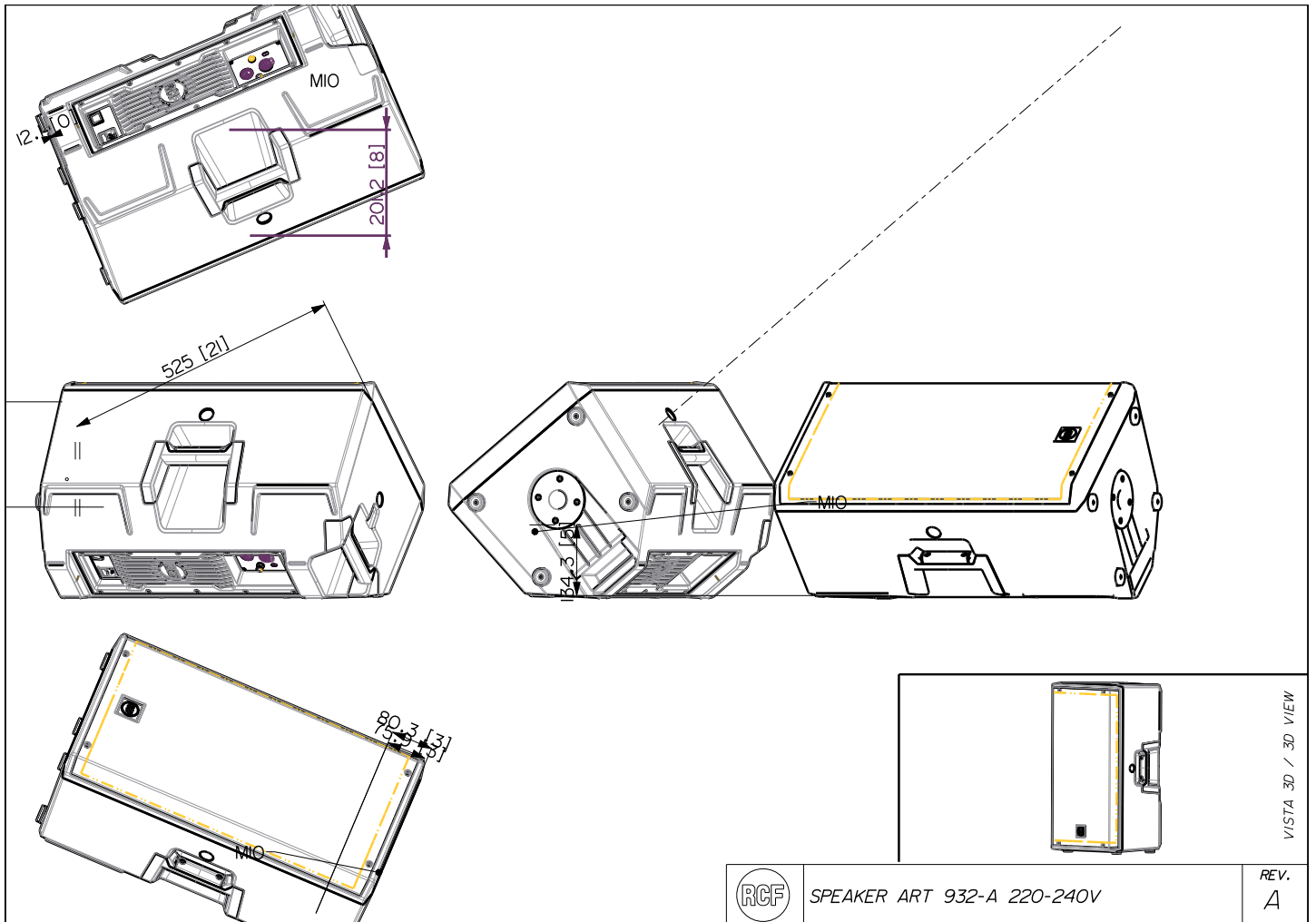

SPEAKER ART 932-A 220-240V

REV.  
A

VISTA 3D / 3D VIEW

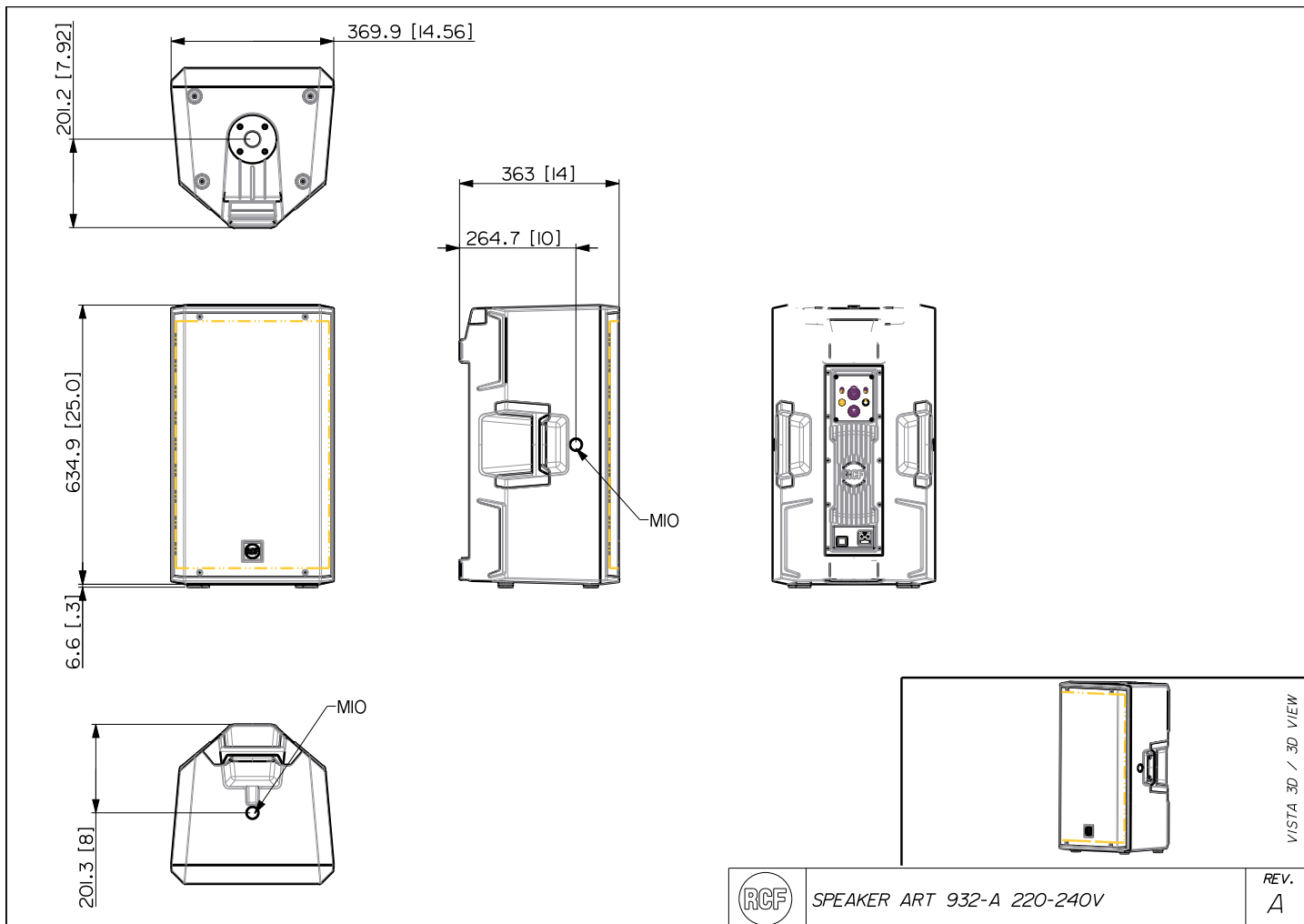

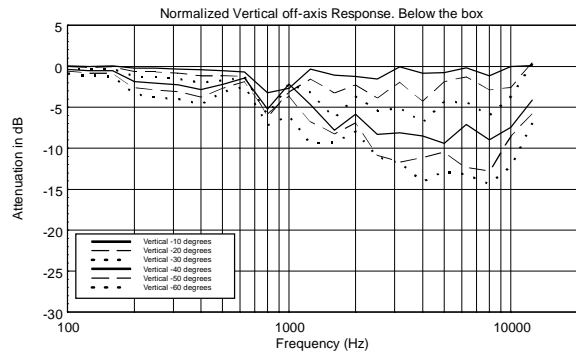
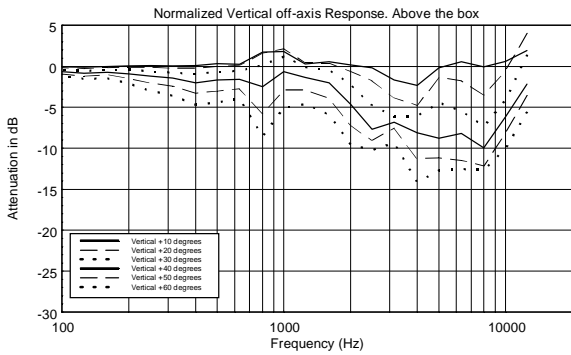
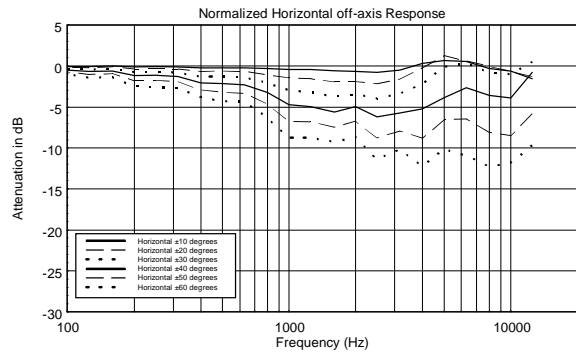
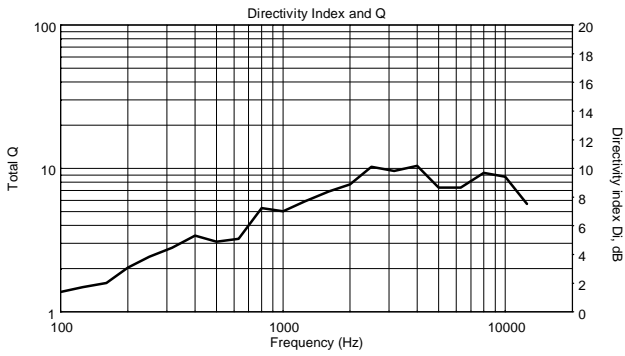
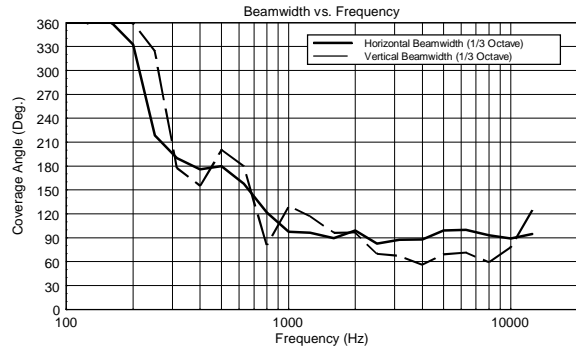
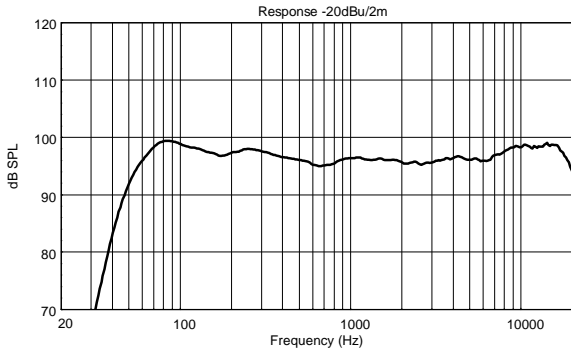

Horizontal 1/3 Octave Polars

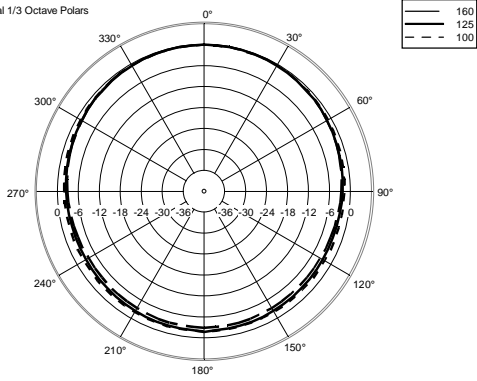

Horizontal 1/3 Octave Polars

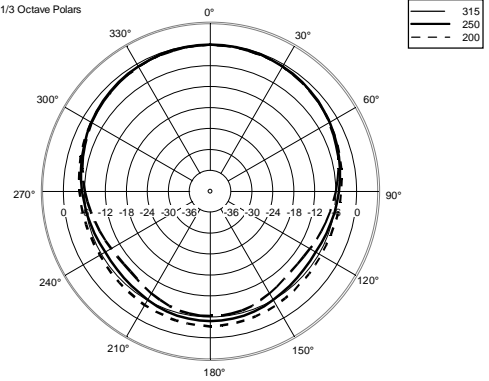

Horizontal 1/3 Octave Polars

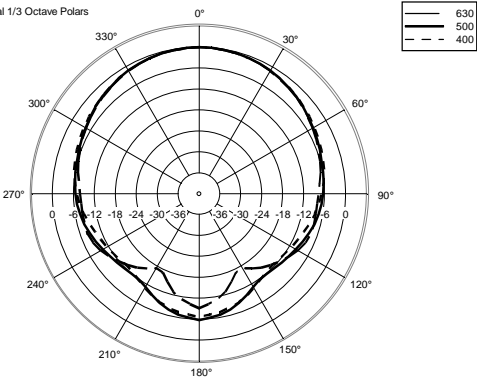

Horizontal 1/3 Octave Polars

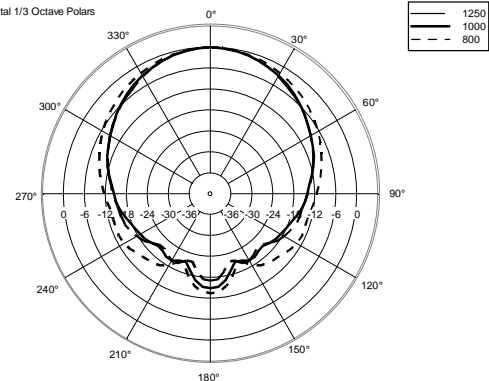

Horizontal 1/3 Octave Polars

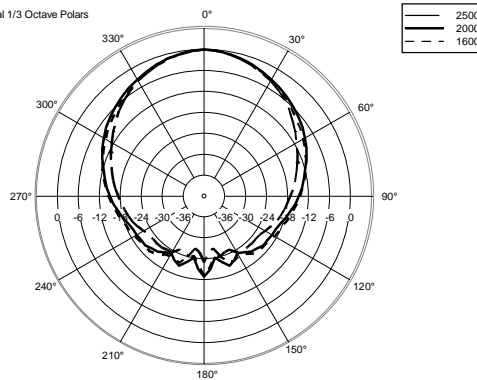

Horizontal 1/3 Octave Polars

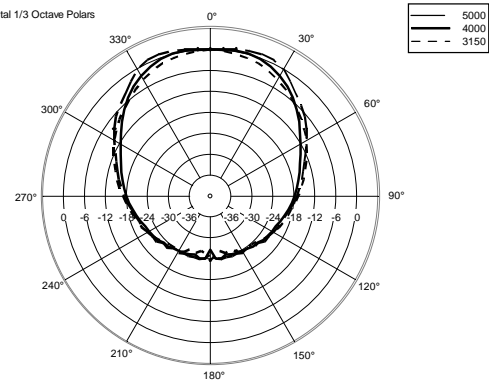

Horizontal 1/3 Octave Polars

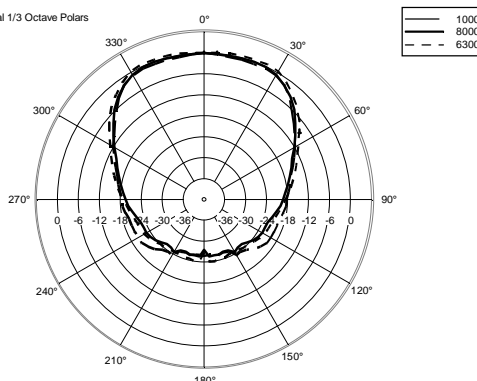



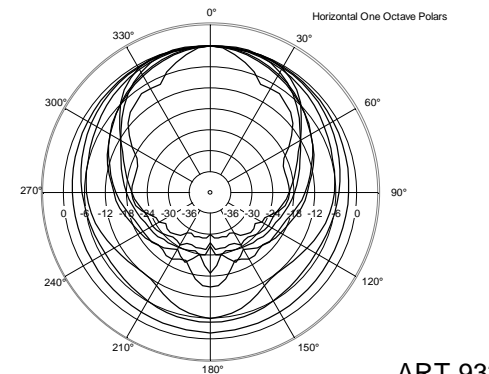

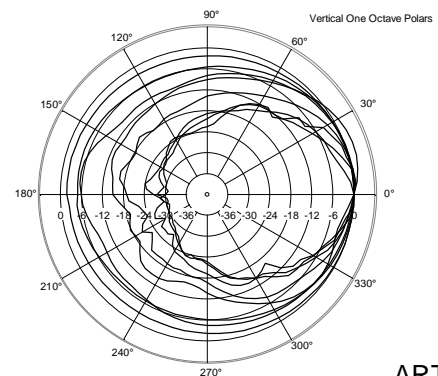
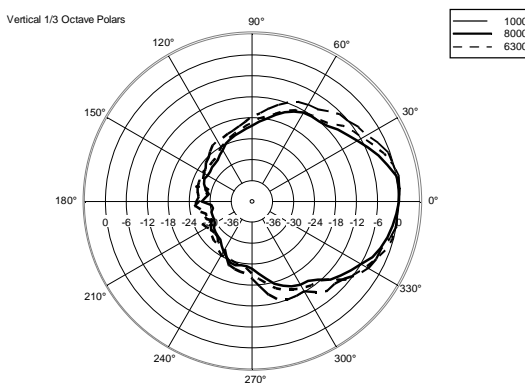
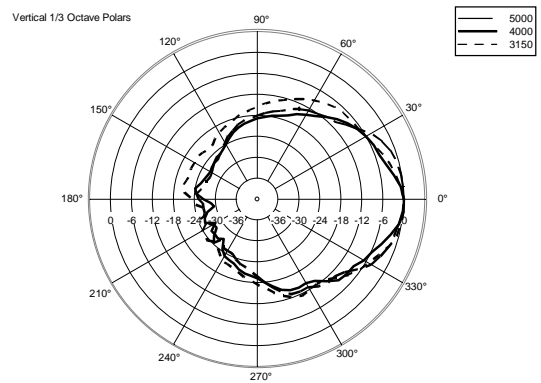
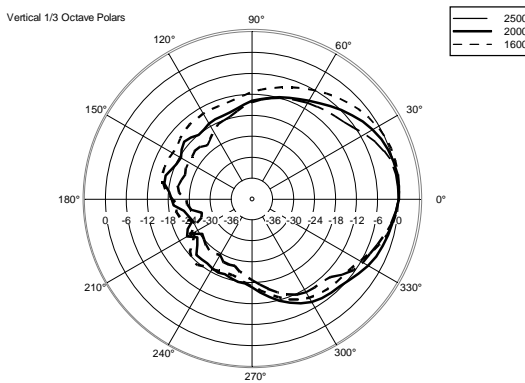
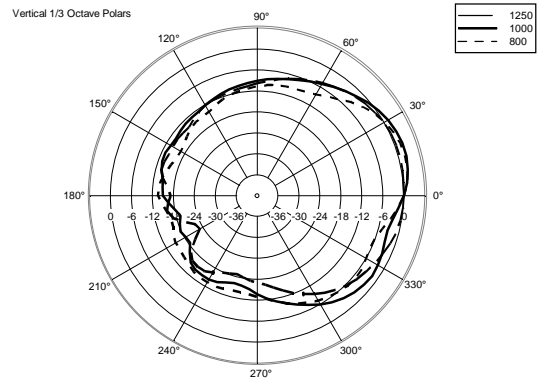
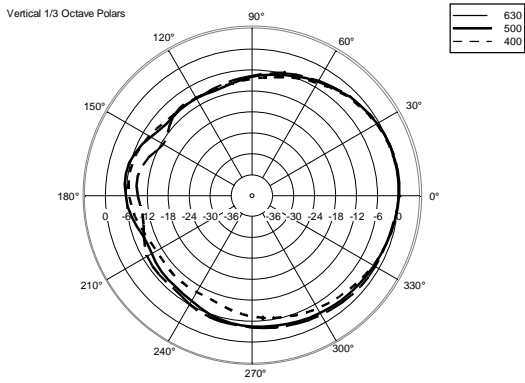
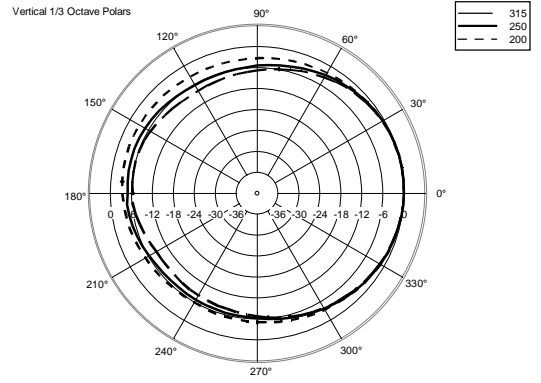
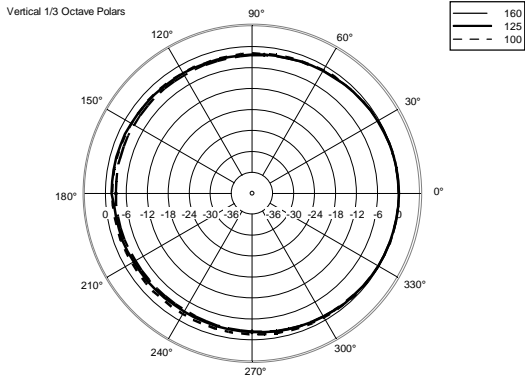



Horizontal One Octave Polars







**ACCESSORIES**

	AC PMA - POLE MOUNT	PART NUMBER EAN:	<b>13360034</b> 8024530007713
	AC PM-M20	PART NUMBER EAN:	<b>13360067</b> 8024530014599
	AC PMX POLE MOUNT M20	PART NUMBER EAN:	<b>13360232</b> 8024530010058
	AC PRO-FS PROFESS. LOCKING FLOOR STAND	PART NUMBER EAN:	<b>13360109</b> 8024530006471
	AC PRO-PM PROFESS. LOCKING POLE MOUNT	PART NUMBER EAN:	<b>13360110</b> 8024530006488
	COVER CVR ART 912	PART NUMBER EAN:	<b>13360474</b> 8024530018849
	FLYING BRACKET FL-BR ART 912	PART NUMBER EAN:	<b>13360477</b> 8024530019204
	HORIZONTAL BRACKET H-BR ART 912	PART NUMBER EAN:	<b>13360475</b> 8024530019228
	VERTICAL BRACKET V-BR ART 912	PART NUMBER EAN:	<b>13360476</b> 8024530019211