

RR3UED

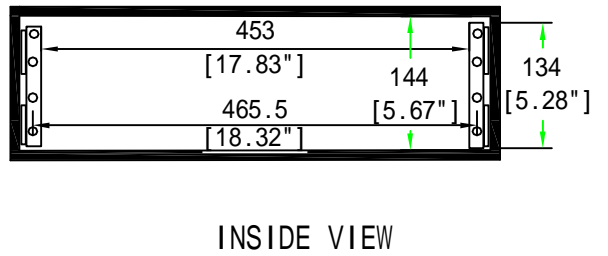
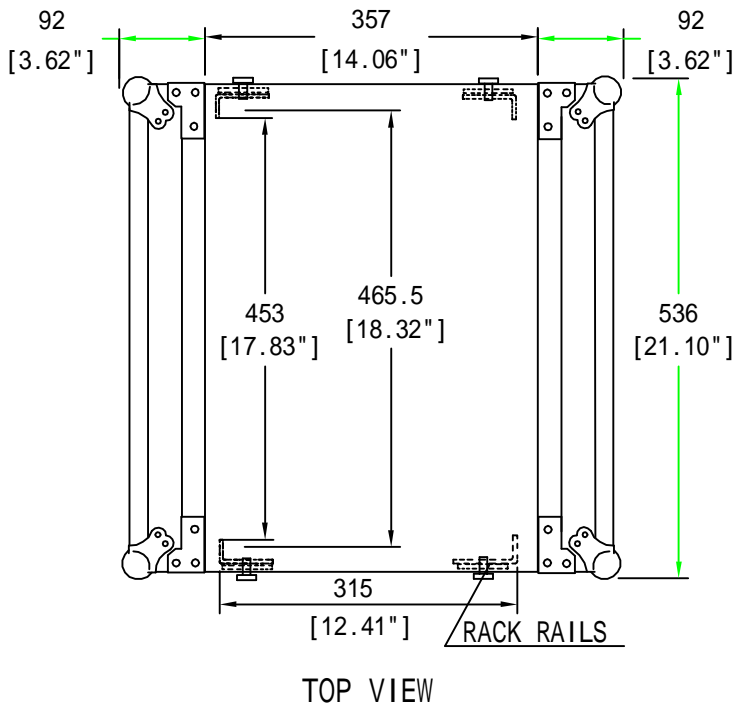
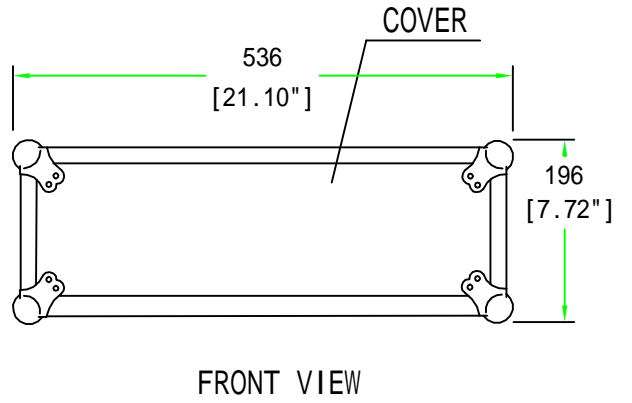
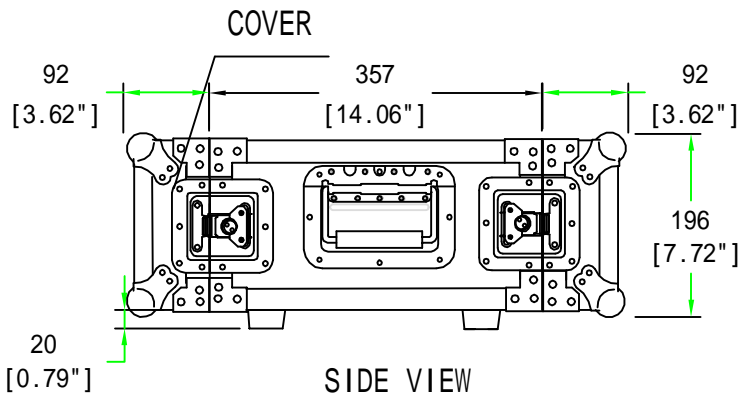

 Signature of Approval

Printed Name

2009-03-20