

CCDJM900NXS2

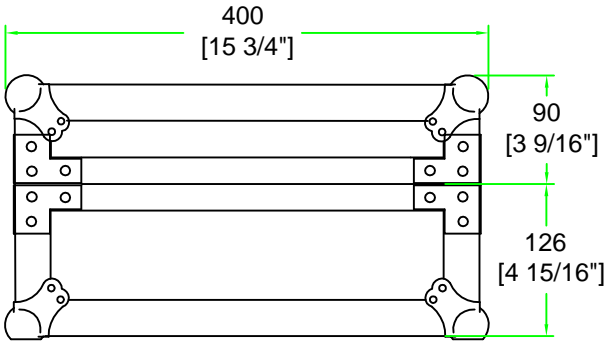

FRONT VIEW

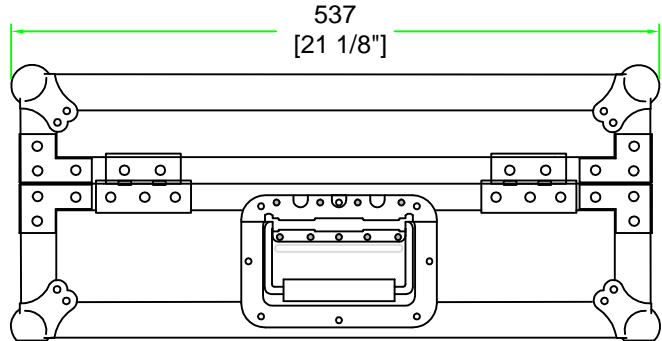

LEFT VIEW

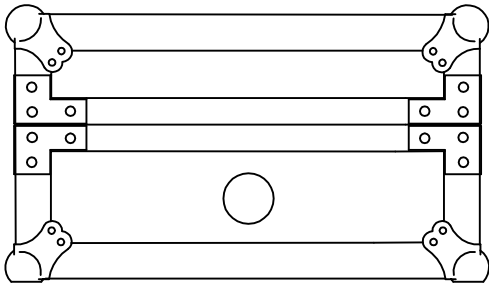

BACK VIEW

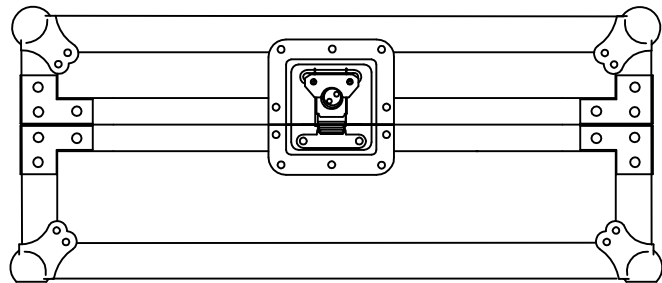

RIGHT VIEW

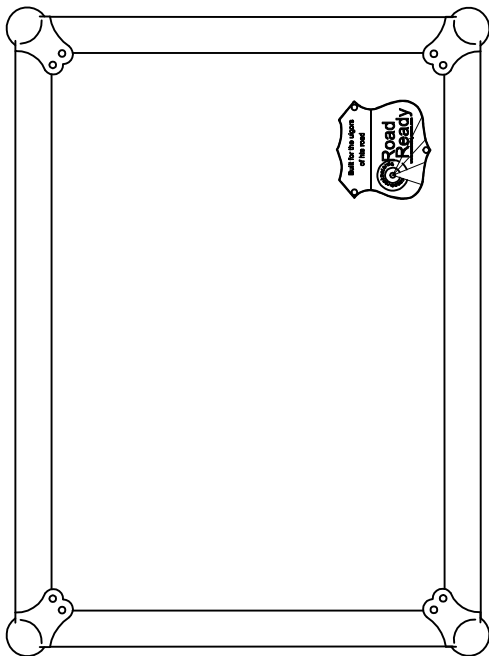

TOP VIEW

	SKU: CCDJM900NXS2	BY:
	UPC: NA	ROAD READY CASES
APPROVAL SIGNATURE:	DATE:	
DRAWING DATE:	SCALE:	DRAWING NUMBER:
02 / 19 / 2016	1:8	1/2
		REVISION:
		NA

CCDJM900NXS2



A-A VIEW

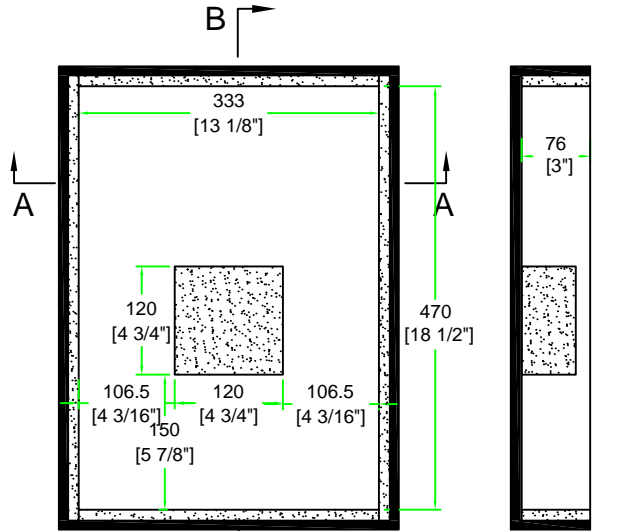

TOP VIEW OF COVER

B-B VIEW

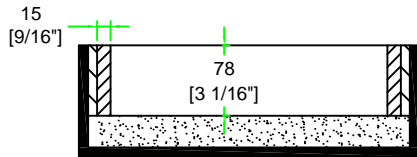

C-C VIEW

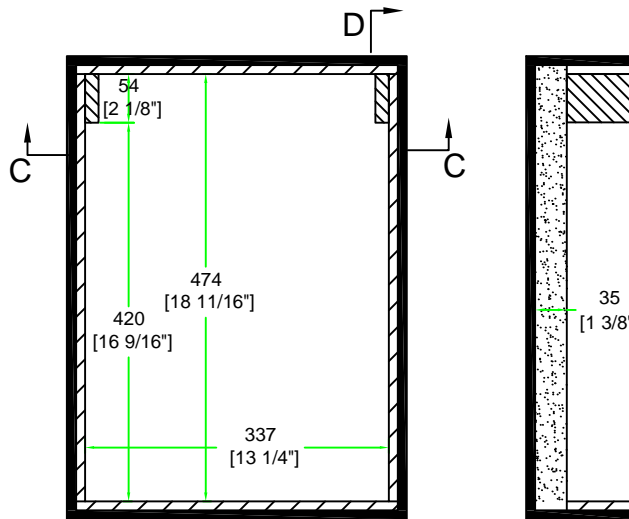

TOP VIEW OF BASE

D-D VIEW

	SKU: CCDJM900NXS2	BY: ROAD READY CASES
	UPC: NA	APPROVAL SIGNATURE: _____ DATE: _____
DRAWING DATE: 02 / 19 / 2016	SCALE: 1:8	DRAWING NUMBER: 2/2
		REVISION: NA