

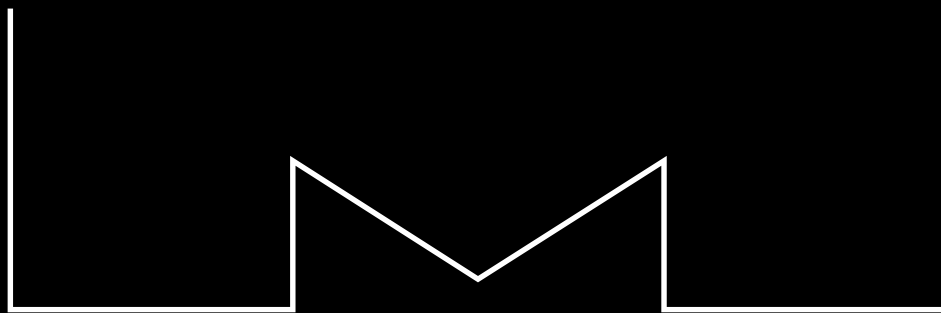

# Bekafun



M U L T I B R A C K E T S

# 2021



#### **BEKAFUN BV**

Heilig Hartstraat 23  
B-8870 Izegem  
info@bekafun.be  
T 051 31 28 03  
BE 0770.510.194

#### **Open**

maandag tot vrijdag van 9u- 18u  
zaterdag van 10u - 17u  
zondag gesloten

Bekafun & EV Sound is doorlopend open,  
ook over de middag

#### **Gesloten**

1-2 januari  
2de Pasen  
1 mei  
Hemelvaart  
Pinkstermaandag  
21 juli  
15 augustus  
1 november  
11 november  
25 december  
(geen jaarlijks verlof)

#### **Bank**

KBC: BE 13 7370 5508 5939  
(BIC: KREDBEBB)

U kan in de winkel betalen met:  
cash / visa / mastercard  
bancontact / payconic  
op rekening na goedkeuring  
(enkel voor klanten met btw nr.)

Online kan u betalen met:  
prepayment / visa / mastercard  
bancontact / payconic  
op rekening na goedkeuring  
(enkel voor klanten met btw nr.)

#### **Volg ons op**



**BEKAFUN** ontstond in 1990 als een beperkte verhuurfirma. Sinds 1998 specialiseren we ons in de verkoop van pro audio, licht en AV aan zowel particuliere DJ's, verhuurfirma's, verenigingen en bedrijven.

### **PRIJS**

Wij proberen goed aan te kopen en zijn niet bang buiten België aan te kopen. Wij bieden een laagste prijs garantie, vindt u hetzelfde product ergens anders goedkoper, dan passen wij onze prijs aan!

**Als professionele klant krijgt u van ons een PRO-account met gepersonaliseerde prijzen en exclusieve promoties.**

### **SERVICE**

Ons sterke punt is onze **2550m<sup>2</sup> stock**. Wij zijn niet zomaar een webshop, opererend vanuit een garage, wij hebben het effectief staan.

Onze **eigen hersteldienst** met kennis van zaken staat steeds paraat voor onderhoud en reparaties van alle producten binnen onze sector.

Op het einde van de rit willen we U de beste prijs geven, op alles, service inbegrepen.

Bekijk ons complete gamma op  
**WWW.BEKAFUN.COM**





## Edito

Multibrackets is een Zweeds familiebedrijf opgericht in 2000. Ze hebben een breed gamma aan kwalitatieve AV-accessoires zoals display- en projectorbeugels, trolley's, projectieschermen, design kabelgoten en meer.

In deze catalogus staan de belangrijkste producten in hun gamma voor onze sector. Prijzen zijn meteen zichtbaar op onze website. Het correcte artikel vind u eenvoudig via het artikelnummer. Typ in het zoekveld bovenaan onze website "mbr-" gevolgd door het artikelnummer uit deze catalogus. Bvb : mbr-7350073732319 voor de M Public Floorstand Basic 150.

Het Bekafun team



DIGITAL SIGNAGE



OFFICE



HOME



PROJECTION SCREENS

# DIGITAL SIGNAGE PRO SERIES

Pro Series is a Digital Signage product series, that can be configured to Ceiling Mounts, Floor to Ceiling Mounts, Menu Boards or Wallmounts. With its modular construction installers have vast possibilities to change, update and reconfigure its design if ideas change. Over time the Pro Series installation can be combined into a wide range of new configurations.

## Wide range of brackets

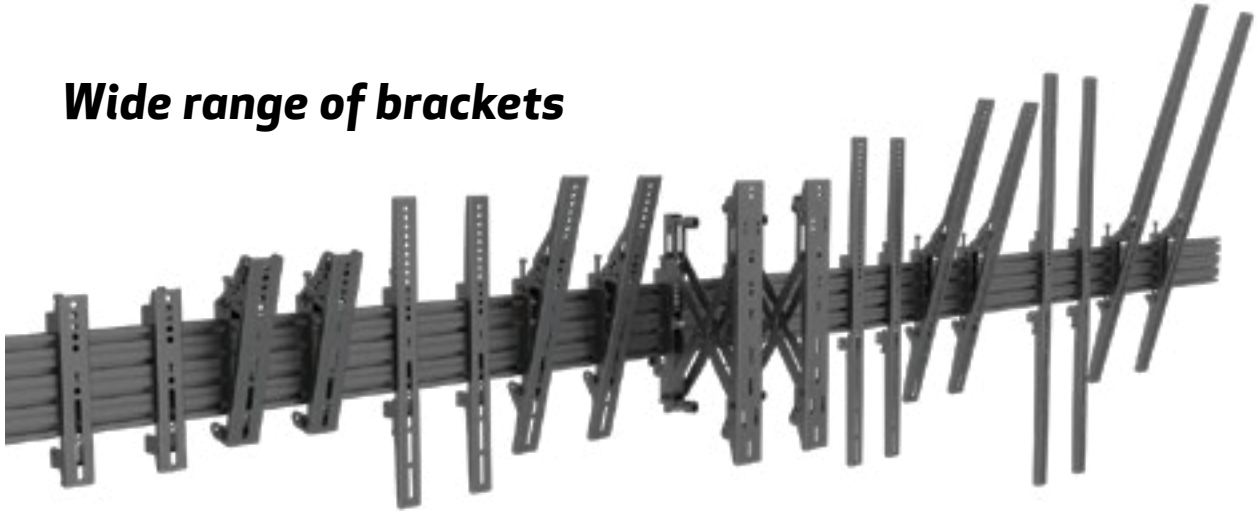

## Precision Leveling

Each mounting bracket allows for micro height adjustments to be made to ensure your screens are levelled and perfectly aligned.

## Extendable Height

The extendable poles allows you to position the center of the screen mounting plate no any height limitation. For tighter spaces, just with single pole to achieve a distance of 80cm.

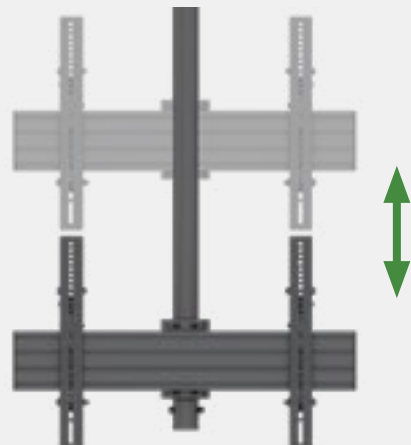

## Easy tilt

Tilt the mounting brackets 5°, 10° or 15° forward to improve line-of-sight while maintaining alignment between your screens. To compensate for potential lean, the brackets can also be angled up to 6° backward.



## Modular design

Available in a wide range of models, Pro Series ceiling mounts support single to 18 screens weighing up to 30kg each. Their modular design allows for additional extrusions to be added to accommodate screens with wider VESA patterns, or to connect multiple units together.

## Easy installation

To reduce strain, the Pro Series uses lightweight ceiling plates that are installed independent of the rest of the mounting system. Simply slide each extension pole into place and secure it to complete the installation. The ceiling plates also provide up to 90° of swing to account for sloped ceilings and support beams, or to secure the mount to a wall.



## Cable management

The extension pole's hollow core provides an unobstructed path to route your cables, while an opening in the mounting plate allows them to continue through the ceiling for a truly professional setup.





# Multibrackets Ceiling Mounted Solutions

Great for installers and digital signage installations. Our ceiling mounted solutions make it possible to construct single, dual or video walls in prominent locations where walls aren't available. Comes in a variety of arrangements.



**PRO SERIES**

# Ceiling Mounts

Our Ceilingmounts was designed to deliver a simple solution for any digital signage installations involving multiple commercial displays 32"-100". Perfect for many commercial installations the space saving design ensures the very best installer experience.

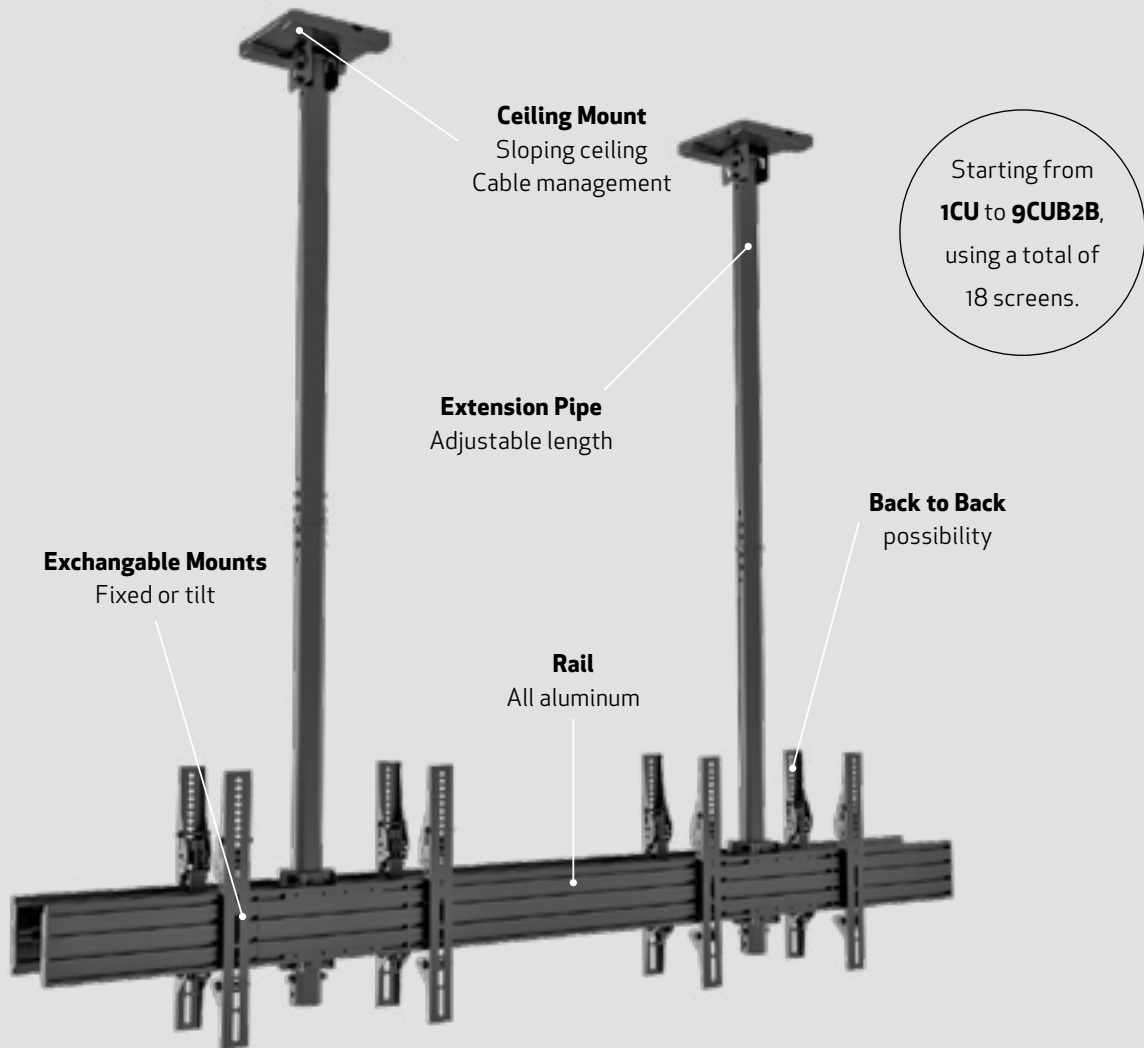

Starting from **1CU to 9CUB2B**, using a total of 18 screens.



Design plate cover ceiling installation



Selected models are TUV approved



Pro Series tested for 5 times the max load



Change color of the poles

Multibrackets MB Pro Ceiling Mount Series is available in a wide range of models

**MBC1U****MBC1U2****MBC2X1U****MBC2X1U2****SPECIFICATION** CEILING MOUNTS

Model name	MBC1U	MBC1UX2	MBC2X1U	MBC2X1U2
<b>Recommended Screen Size</b>	40" - 65"	40" - 65"	40" - 65"	40" - 65"
<b>VESA® &amp; Non-VESA Fixings</b>	VESA 600x400	VESA 600x400, 40cm	VESA400, 40cm	VESA400, 40cm
<b>Article Nr / EAN</b>	7350073733446	7350073733453	7350073733460	7350073733491
<b>Max Load</b>	50kg (TUV30kg) Per screen	50kg (TUV30kg) Per screen	50kg (TUV30kg) Per screen	50kg (TUV30kg) Per screen
<b>Bracket Type</b>	Tilt (Fixed optional)	Tilt (Fixed optional)	Tilt (Fixed optional)	Tilt (Fixed optional)
<b>Landscape / Portrait</b>	Yes	Yes	Yes	Yes
<b>Pole Length</b>	80 cm up to 150 cm	80 cm up to 150 cm	80 cm up to 300 cm	80 cm up to 300 cm
<b>Colour (VESA Arms)</b>	Black	Black	Black	Black
<b>Colour (Horizontal Rail)</b>	Black (Silver optional)	Black (Silver optional)	Black (Silver optional)	Black (Silver optional)
<b>Colour (Poles &amp; Ceiling Mount)</b>	Black	Black	Black	Black
<b>Warranty</b>	5 years	5 years	5 years	5 years
<b>Accessories</b>	Cover plates	Cover plates	Cover plates	Cover plates





**MBC3X1U****MBC3X1U2****MBC4X1U****MBC4X1U2****SPECIFICATION** CEILING MOUNTS

Model name	MBC3X1U	MBC3X1U2	MBC4X1U	MBC4X1U2
<b>Recommended Screen Size</b>	40" - 65"	40" - 65"	40" - 65"	40" - 65"
<b>VESA® &amp; Non-VESA Fixings</b>	VESA400,40cm	VESA400,40cm	VESA400,40cm	VESA400,40cm
<b>Article Nr / EAN</b>	7350073733477	7350073733507	7350073733484	7350073733514
<b>Max Load</b>	50kg (TUV30kg) Per screen	50kg (TUV30kg) Per screen	50kg (TUV30kg) Per screen	50kg (TUV30kg) Per screen
<b>Bracket Type</b>	Tilt (Fixed optional)	Tilt (Fixed optional)	Tilt (Fixed optional)	Tilt (Fixed optional)
<b>Landscape / Portrait</b>	Yes	Yes	Yes	Yes
<b>Pole Length</b>	80 cm up to 150 cm	80 cm up to 150 cm	80 cm up to 150 cm	80 cm up to 300 cm
<b>Colour (VESA Arms)</b>	Black	Black	Black	Black
<b>Colour (Horizontal Rail)</b>	Black (Silver optional)	Black (Silver optional)	Black (Silver optional)	Black (Silver optional)
<b>Colour (Poles &amp; Ceiling Mount)</b>	Black	Black	Black	Black
<b>Warranty</b>	5 years	5 years	5 years	5 years
<b>Accessories</b>	Cover plates	---	Cover plates	---



**MBC2U****MBC2U2****MBC2X2U****MBC2X2U2****SPECIFICATION** CEILING MOUNTS

Model name	MBC2U	MBC2U2	MBC2X2U	MBC2X2U2
<b>Recommended Screen Size</b>	40" - 65"	40" - 65"	40" - 65"	40" - 65"
<b>VESA® &amp; Non-VESA Fixings</b>	VESA400,40cm	VESA400,40cm	VESA400,40cm	VESA400,40cm
<b>Article Nr / EAN</b>	7350073733545	7350073733583	7350073733552	7350073733590
<b>Max Load</b>	50kg (TUV30kg) Per screen	50kg (TUV30kg) Per screen	50kg (TUV30kg) Per screen	50kg (TUV30kg) Per screen
<b>Bracket Type</b>	Fixed	Fixed	Fixed	Fixed
<b>Landscape / Portrait</b>	Yes	Yes	Yes	Yes
<b>Pole Length</b>	80 cm up to 150 cm	80 cm up to 150 cm	80 cm up to 300 cm	80 cm up to 300 cm
<b>Colour (VESA Arms)</b>	Black	Black	Black	Black
<b>Colour (Horizontal Rail)</b>	Black (Silver optional)	Black (Silver optional)	Black (Silver optional)	Black (Silver optional)
<b>Colour (Poles &amp; Ceiling Mount)</b>	Black	Black	Black	Black
<b>Warranty</b>	5 years	5 years	5 years	5 years
<b>Accessories</b>	Cover plates	---	Cover plates	---



# MBC3x3U2

**BACK TO BACK POSSIBILITY**

**CEILING MOUNT**

Sloping ceiling  
Cable management

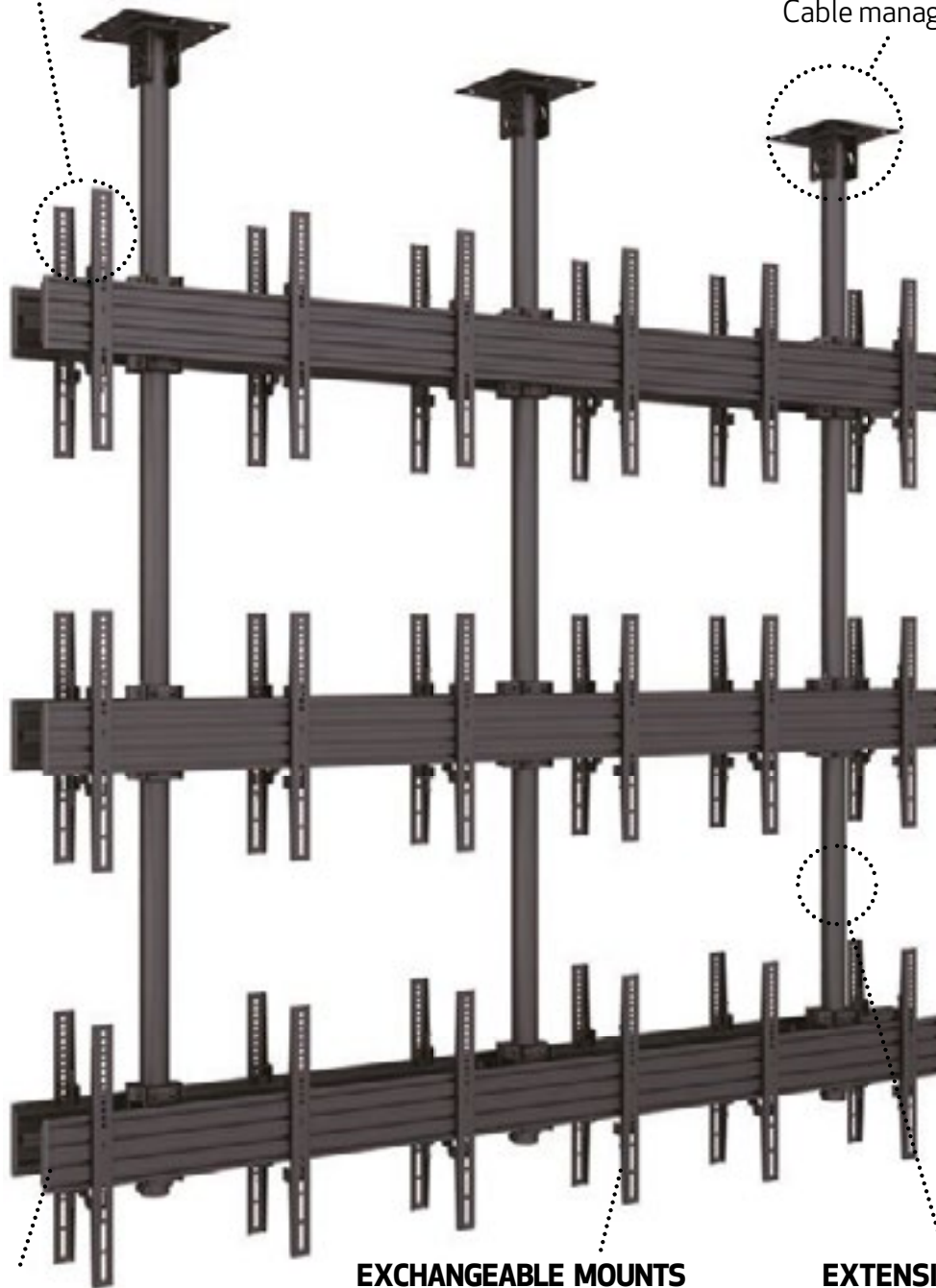

**RAIL**  
All aluminum

**EXCHANGEABLE MOUNTS**  
Fixed or tilt

**EXTENSION PIPE**  
Adjustable length

## SPECIFICATION MBC3x3U2

<b>Recommended Screen Size</b>	32" - 65"	<b>Pole Length</b>	80 cm up to 300 cm
<b>VESA® &amp; Non-VESA Fixings</b>	VESA400,40cm	<b>Colour (VESA Arms)</b>	Black
<b>Article Nr / EAN</b>	7350073733613	<b>Colour (Horizontal Rail)</b>	Black (Silver optional)
<b>Max Load</b>	50kg (TUV30kg) Per screen	<b>Colour (Poles &amp; Ceiling Mount)</b>	Black
<b>Bracket Type</b>	Fixed	<b>Warranty</b>	5 years
<b>Landscape / Portrait</b>	Yes		



## MBC4x4 Adjustable

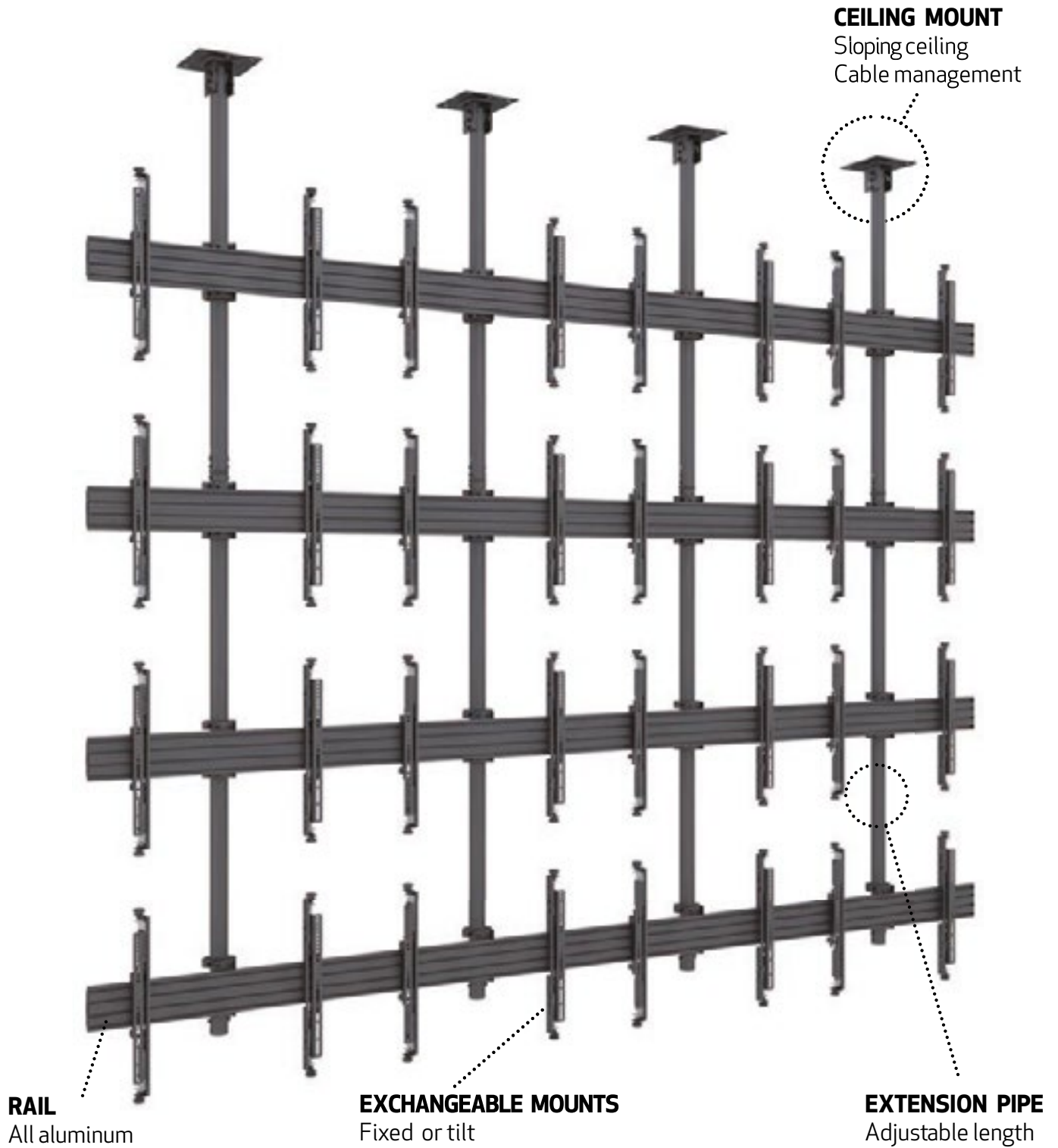

**RAIL**  
All aluminum

**EXCHANGEABLE MOUNTS**  
Fixed or tilt

**EXTENSION PIPE**  
Adjustable length

**CEILING MOUNT**  
Sloping ceiling  
Cable management

### SPECIFICATION MBC4X4

<b>Recommended Screen Size</b>	32" - 65"	<b>Pole Length</b>	80 cm up to 300 cm
<b>VESA® &amp; Non-VESA Fixings</b>	VESA400,40cm	<b>Colour (VESA Arms)</b>	Black
<b>Article Nr / EAN</b>	7350073737864	<b>Colour (Horizontal Rail)</b>	Black (Silver optional)
<b>Max Load</b>	50kg (TUV30kg) Per screen	<b>Colour (Poles &amp; Ceiling Mount)</b>	Black
<b>Bracket Type</b>	Micro-Adjustable Arms	<b>Warranty</b>	5 years
<b>Landscape / Portrait</b>	Yes		



**MBC3X2U****MBC3X2U2****MBC3X3U****MBC3U****SPECIFICATION** CEILING MOUNTS

Model name	MBC3X2U	MBC3X2U2	MBC3X3U	MBC3U
<b>Recommended Screen Size</b>	32" - 65"	32" - 65"	32" - 65"	32" - 65"
<b>VESA® &amp; Non-VESA Fixings</b>	VESA400,40cm	VESA400,40cm	VESA400,40cm	VESA400,40cm
<b>Article Nr / EAN</b>	7350073733569	7350073733606	7350073733576	7350073733521
<b>Max Load</b>	50kg (TUV30kg) Per screen	50kg (TUV30kg) Per screen	50kg (TUV30kg) Per screen	50kg (TUV30kg) Per screen
<b>Bracket Type</b>	Fixed	Fixed	Fixed	Tilt
<b>Landscape / Portrait</b>	Yes	Yes	Yes	Yes
<b>Pole Length</b>	80 cm up to 300 cm	80 cm up to 300 cm	80 cm up to 300 cm	80 cm up to 300 cm
<b>Colour (VESA Arms)</b>	Black	Black	Black	Black
<b>Colour (Horizontal Rail)</b>	Black (Silver optional)	Black (Silver optional)	Black (Silver optional)	Black (Silver optional)
<b>Colour (Poles &amp; Ceiling Mount)</b>	Black	Black	Black	Black
<b>Warranty</b>	5 years	5 years	5 years	5 years
<b>Accessories</b>	Cover plates	---	---	---



# MBC4U

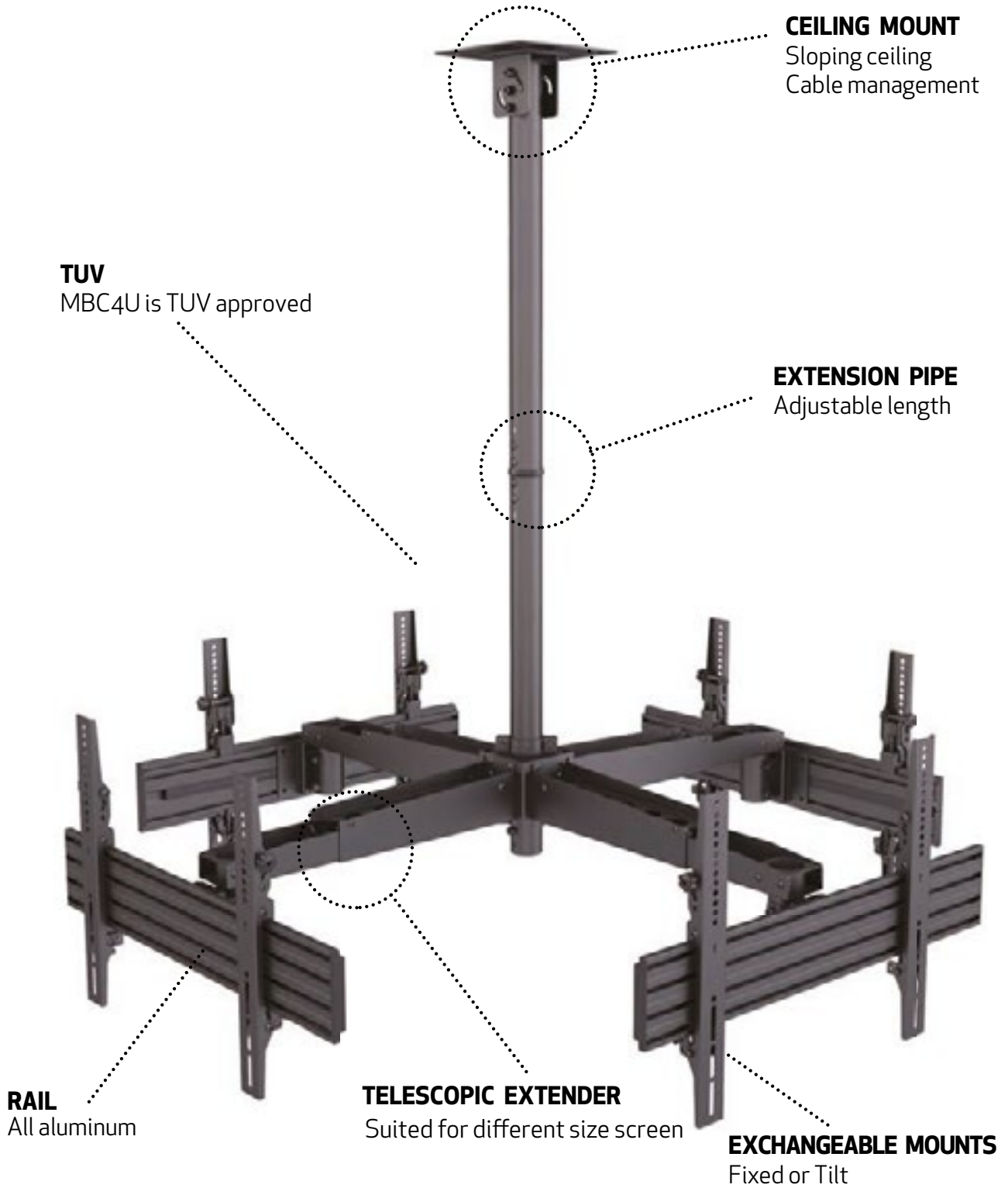

**CEILING MOUNT**  
Sloping ceiling  
Cable management

**TUV**  
MBC4U is TUV approved

**EXTENSION PIPE**  
Adjustable length

**RAIL**  
All aluminum

**TELESCOPIC EXTENDER**  
Suited for different size screen

**EXCHANGEABLE MOUNTS**  
Fixed or Tilt

## SPECIFICATION MBC4U

<b>Recommended Screen Size</b>	32" - 65"	<b>Pole Length</b>	80 cm up to 300 cm
<b>VESA® &amp; Non-VESA Fixings</b>	VESA400 ,40cm	<b>Colour (VESA Arms)</b>	Black
<b>Article Nr / EAN</b>	7350073733538	<b>Colour (Horizontal Rail)</b>	Black (Silver optional)
<b>Max Load</b>	50kg (TUV30kg) Per screen	<b>Colour (Poles &amp; Ceiling Mount)</b>	Black
<b>Bracket Type</b>	Tilt (Fixed optional)	<b>Warranty</b>	5years
<b>Landscape / Portrait</b>	Yes		



## PRO SERIES

# UHD Large Screen Ceiling Mounts

The Dual Pole range of Pro Series floorstand 's designed to support one or two large size screens mounted back-to-back in either landscape or portrait. Simple to install, clean and attractive design, yet very robust and functional the Dual Pole series is ideal for a wide variety of applications and settings. Designed to provide the ideal display viewing placement and match the décor of any environment. Ideal for public areas like stores, training rooms, lobbies, classrooms, auditoriums, or exhibit halls. As with all Pro series products a full line-up of accessories offering tailor possibilities functionality to meet your specific requirements. Internal cable management hides the AV cabling, showing a clean look.

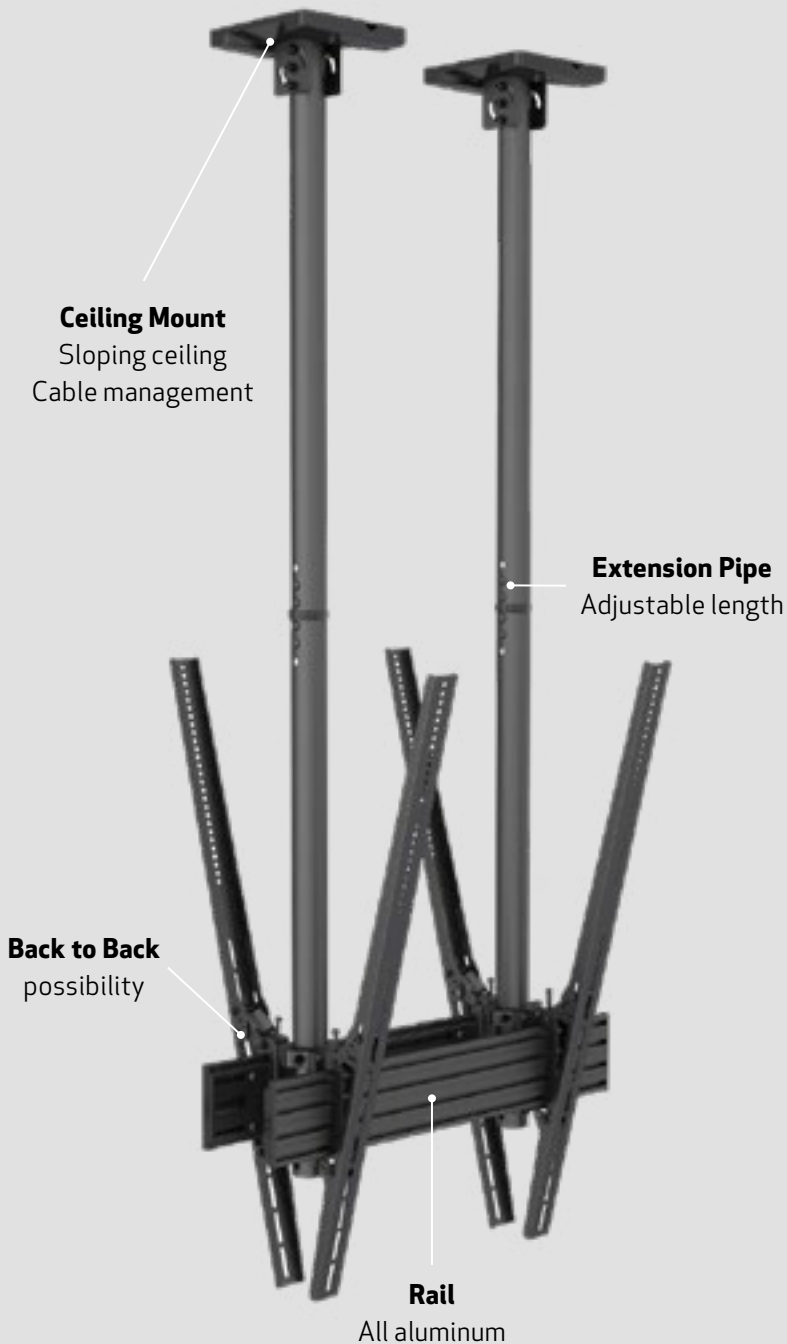

Design plate cover ceiling installation



Selected models are TUV approved



Pro Series tested for 5 times the max load

UHD Large Screen Ceilingmounts is available in the large size screen ceilingmounts

**MBC1UHD****MBC1USD****MBC1UX2HD****MBC1UX2SD****SPECIFICATION** CEILING MOUNTS

Model name	MBC1UHD	MBC1USD	MBC1UX2HD	MBC1UX2SD
<b>Recommended Screen Size</b>	40" - 75"	40" - 100"	40" - 75"	40" - 100"
<b>VESA® &amp; Non-VESA Fixings</b>	VESA600,60cm	VESA600,60cm	VESA600,60cm	VESA600,60cm
<b>Article Nr / EAN</b>	7350073735778	7350073735785	7350073736232	7350073736249
<b>Max Load</b>	90kg (Per screen)	135kg (Per screen)	90kg (Per screen)	90kg (Per screen)
<b>Bracket Type</b>	Tilt (Fixed optional)	Tilt (Fixed optional)	Tilt (Fixed optional)	Tilt (Fixed optional)
<b>Landscape / Portrait</b>	Yes	Yes	Yes	Yes
<b>Pole Length</b>	580 cm up to 1550 cm	580 cm up to 1550 cm	580 cm up to 1550 cm	580 cm up to 1550 cm
<b>Colour (VESA Arms)</b>	Black	Black	Black	Black
<b>Colour (Horizontal Rail)</b>	Black (Silver optional)	Black (Silver optional)	Black (Silver optional)	Black (Silver optional)
<b>Colour (Poles &amp; Ceiling Mount)</b>	Black	Black	Black	Black
<b>Warranty</b>	5 years	5 years	5 years	5 years
<b>Accessories</b>	Cover plates	Cover plates	---	---





**MBC1UPHD****MBC1UPSD****MBC1UX2PHD****MBC1UX2PSD****SPECIFICATION** CEILING MOUNTS

Model name	MBC1UPHD	MBC1UPSD	MBC1UX2PHD	MBC1UX2PSD
<b>Recommended Screen Size</b>	40" - 75"	40" - 100"	40" - 75"	40" - 100"
<b>VESA® &amp; Non-VESA Fixings</b>	VESA900,90cm	VESA900,90cm	VESA900,90cm	VESA900,90cm
<b>Article Nr / EAN</b>	7350073736126	7350073736133	7350073736256	7350073736263
<b>Max Load</b>	90kg (Per screen)	180kg (Per screen)	90kg (Per screen)	90kg (Per screen)
<b>Bracket Type</b>	Tilt (Fixed optional)	Tilt (Fixed optional)	Tilt (Fixed optional)	Tilt (Fixed optional)
<b>Landscape / Portrait</b>	Yes	Yes	Yes	Yes
<b>Pole Length</b>	580 cm up to 1550 cm	580 cm up to 1550 cm	580 cm up to 1550 cm	580 cm up to 1550 cm
<b>Colour (VESA Arms)</b>	Black	Black	Black	Black
<b>Colour (Horizontal Rail)</b>	Black (Silver optional)	Black (Silver optional)	Black (Silver optional)	Black (Silver optional)
<b>Colour (Poles &amp; Ceiling Mount)</b>	Black	Black	Black	Black
<b>Warranty</b>	5 years	5 years	5 years	5 years
<b>Accessories</b>	Cover plates	Cover plates	---	---





# Multibrackets Mounted Menu Board Solutions

Great for installers and digital signage installations. Our ceiling mounted menu boards make it possible to construct single, dual or video walls in prominent locations where walls aren't available. Comes in a variety of arrangements.



**PRO SERIES**

# Menuboard Mounts

Menu Boards has quickly become a simple way to interact with the consumer. State-of-the-art MB Pro Series menu boards simplifies the installation process of a menu board in prominent location. A complete range of models and exchangeable bracket solutions makes it easy to find a suitable solution plus bring speed to the installation.

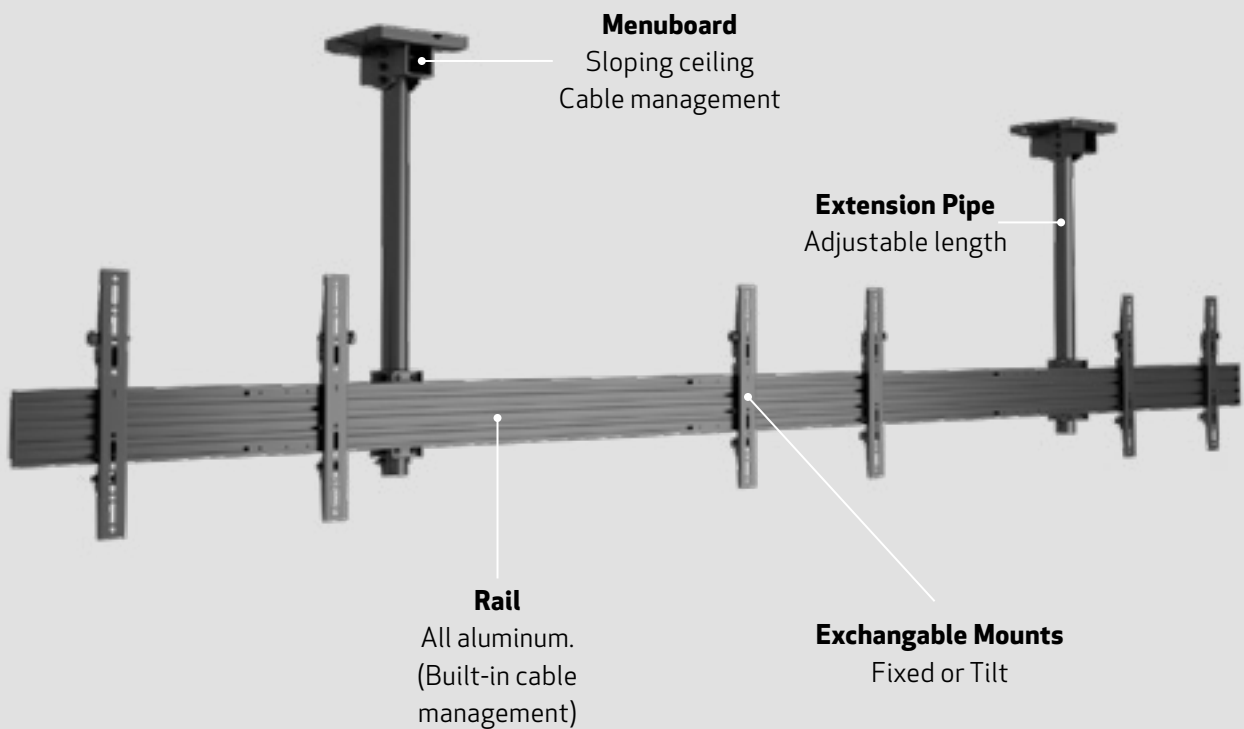

Design plate cover ceiling installation



Selected models are TUV approved



Pro Series tested for 5 times the max load

MB Pro Menuboard Mount Series is available in the large size screen ceiling mounts

**MBC2X1U**

Landscape

**MBC3X1UP**

Portrait

To create portrait version,  
pls add a set of brackets**MBC3X1U**

Landscape

**MBC4X1UP**

Portrait

To create portrait version,  
pls add a set of brackets**SPECIFICATION MENUBOARDS**

Model name	MBC2X1U	MBC3X1UP	MBC3X1U	MBC4X1UP
<b>Recommended Screen Size</b>	32" - 65"	32" - 65"	32" - 65"	32" - 65"
<b>VESA® &amp; Non-VESA Fixings</b>	VESA400,40cm	VESA400,40cm	VESA400,40cm	VESA400,40cm
<b>Article Nr / EAN</b>	7350073733460	7350073734924	7350073733477	7350073734931
<b>Max Load</b>	50kg (TUV30kg) Per screen	50kg (TUV30kg) Per screen	50kg (TUV30kg) Per screen	50kg (TUV30kg) Per screen
<b>Bracket Type</b>	Tilt (Fixed optional)	Tilt (Fixed optional)	Tilt (Fixed optional)	Tilt (Fixed optional)
<b>Landscape / Portrait</b>	Yes	Yes	Yes	Yes
<b>Pole Length</b>	80 cm up to 150 cm	80 cm up to 150 cm	80 cm up to 150 cm	80 cm up to 300 cm
<b>Colour (VESA Arms)</b>	Black	Black	Black	Black
<b>Colour (Horizontal Rail)</b>	Black (Silver optional)	Black (Silver optional)	Black (Silver optional)	Black (Silver optional)
<b>Colour (Poles &amp; Ceiling Mount)</b>	Black	Black	Black	Black
<b>Warranty</b>	5 years	5 years	5 years	5 years
<b>Accessories</b>	Cover plates	Cover plates	Cover plates	Cover plates



## MBC4X1U

Available in portrait & landscape mode



To create portrait version,  
add a set of brackets.

### SPECIFICATION MENUBOARDS

Model name	MBC4X1U	MBC5X1UP
Recommended Screen Size	32" - 65"	32" - 65"
VESA® & Non-VESA Fixings	VESA400,40cm	VESA400,40cm
Article Nr / EAN	7350073733484	7350073734948
Max Load	50kg (TUV30kg) Per screen	50kg (TUV30kg) Per screen
Bracket Type	Tilt (Fixed optional)	Tilt (Fixed optional)
Landscape / Portrait	Yes	Yes
Pole Length	80 cm up to 150 cm	80 cm up to 150 cm
Colour (VESA Arms)	Black	Black
Colour (Horizontal Rail)	Black (Silver optional)	Black (Silver optional)
Colour (Poles & Ceiling Mount)	Black	Black
Warranty	5 years	5 years
Accessories	Cover plates	Cover plates



## MBC2X1U VESA 200



## MBC3X1U VESA 200



## MBC4X1U VESA 200

Technical drawings available online

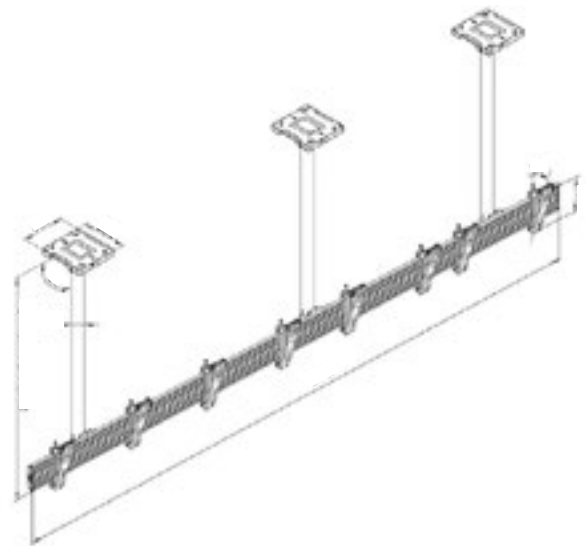

### SPECIFICATION MENUBOARDS

Model name	MBC2X1U VESA 200	MBC3X1U VESA 200	MBC4X1U VESA 200
<b>Recommended Screen Size</b>	32" - 42"	32" - 42"	32" - 42"
<b>VESA® &amp; Non-VESA Fixings</b>	VESA200 ,20cm	VESA200 ,20cm	VESA200 ,20cm
<b>Article Nr / EAN</b>	7350073735655	7350073735662	7350073735679
<b>Max Load</b>	50kg (TUV30kg) Per screen	50kg (TUV30kg) Per screen	50kg (TUV30kg) Per screen
<b>Bracket Type</b>	Tilt (Fixed optional)	Tilt (Fixed optional)	Tilt (Fixed optional)
<b>Landscape / Portrait</b>	Yes	Yes	Yes
<b>Pole Length</b>	80 cm up to 150 cm	80 cm up to 150 cm	80 cm up to 150 cm
<b>Colour (VESA Arms)</b>	Black	Black	Black
<b>Colour (Horizontal Rail)</b>	Black (Silver optional)	Black (Silver optional)	Black (Silver optional)
<b>Colour (Poles &amp; Ceiling Mount)</b>	Black	Black	Black
<b>Warranty</b>	5 years	5 years	5 years
<b>Accessories</b>	Cover plates	Cover plates	Cover plates



**MBW2U** Menu Board Wall**MBC3X1UP** Menu Board Wall

Portrait

**MBW3U** Menu Board Wall**MBC4X1UP** Menu Board Wall

Portrait

**SPECIFICATION** MENUBOARDS

Model name	MBW2U	MBC3X1UP	MBW3U	MBC4X1UP
<b>Recommended Screen Size</b>	32" - 65"	32" - 65"	32" - 65"	32" - 65"
<b>VESA® &amp; Non-VESA Fixings</b>	VESA400,40cm	VESA400,40cm	VESA400,40cm	VESA400,40cm
<b>Article Nr / EAN</b>	7350073734061	7350073734061+7350073733743	7350073734078	7350073734078+7350073733743
<b>Max Load</b>	50kg (TUV30kg) Per screen	50kg (TUV30kg) Per screen	50kg (TUV30kg) Per screen	50kg (TUV30kg) Per screen
<b>Bracket Type</b>	Tilt (Fixed optional)	Tilt (Fixed optional)	Tilt (Fixed optional)	Tilt (Fixed optional)
<b>Landscape / Portrait</b>	Yes	Yes	Yes	Yes
<b>Colour (VESA Arms)</b>	Black	Black	Black	Black
<b>Colour (Horizontal Rail)</b>	Black(Silver optional)	Black(Silver optional)	Black(Silver optional)	Black(Silver optional)
<b>Colour (Poles &amp; Ceiling Mount)</b>	Black	Black	Black	Black
<b>Warranty</b>	5 years	5 years	5 years	5 years





# Multibrackets Floor to Ceiling Solutions

Our floor to ceiling solutions makes it possible to construct menu boards in prominent locations where walls aren't available. An aesthetic solution that adds stability to locations where the ceiling or wall aren't able to support an installation.





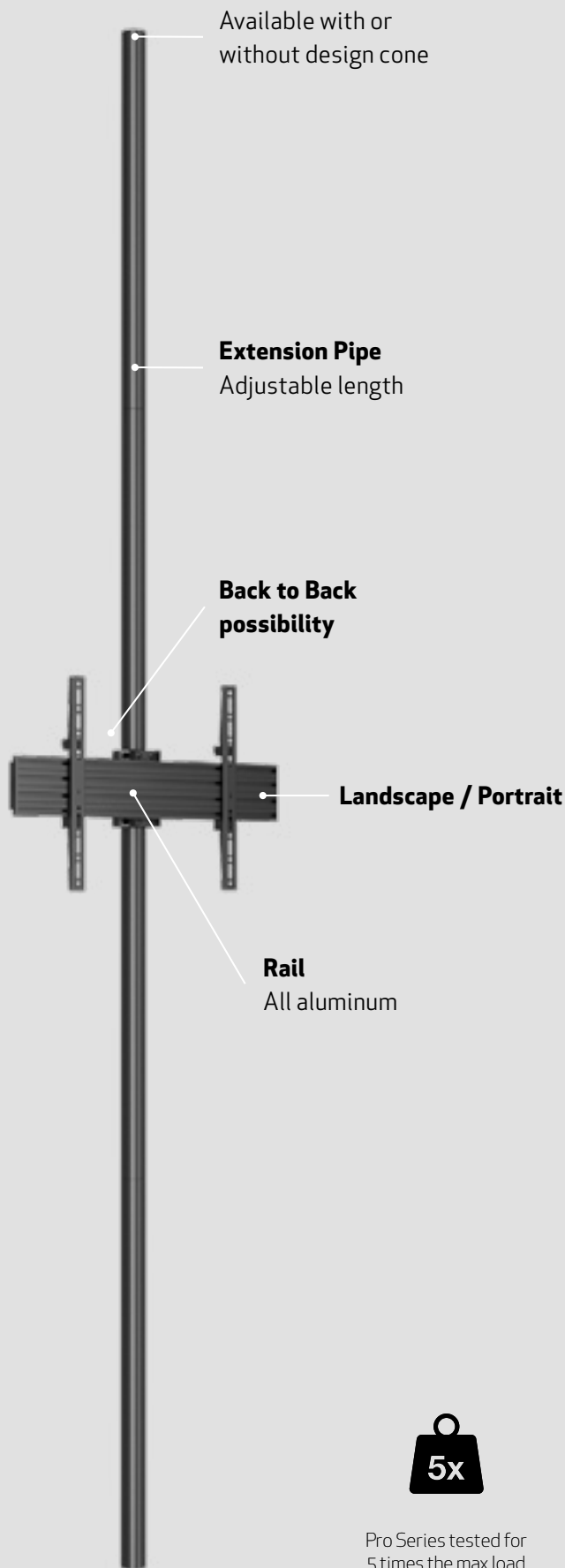

Available with or without design cone

**Extension Pipe**  
Adjustable length

**Back to Back possibility**

**Landscape / Portrait**

**Rail**  
All aluminum

## PRO SERIES

# Floor to Ceiling Mounts

In store Digital Signage is one of the fastest growing sector of the POS market. Our unique floor to ceiling mounts solutions are both dynamic and flexible and often becomes an immediate focal point with holding a display with modern looks and eye catching clean appearance.

**New model:**

**MBFC1UD:** 7350073737734

*As shown on picture*



Design cone cover floor and ceiling mount



Selected models are TUV approved



Pro Series tested for 5 times the max load



Design plate cover ceiling installation



Change color of the poles

MB Pro Floor to Ceiling Mount Series is available in a wide range of models

**MBFC1U****MBFC1U Brass****MBFC1U Chrome****MBFC1U White****SPECIFICATION FLOOR TO CEILING**

Model name	MBFC1U	MBFC1U Brass	MBFC1U Chrome	MBFC1U White
<b>Recommended Screen Size</b>	32" - 65"	32" - 65"	32" - 65"	32" - 65"
<b>VESA® &amp; Non-VESA Fixings</b>	VESA400,40cm	VESA400,40cm	VESA400,40cm	VESA400,40cm
<b>Article Nr / EAN</b>	7350073733620	7350073735709	7350073735693	7350073735686
<b>Max Load</b>	50kg (TUV30kg) Per screen	50kg (TUV30kg) Per screen	50kg (TUV30kg) Per screen	50kg (TUV30kg) Per screen
<b>Bracket Type</b>	Fixed	Fixed	Fixed	Fixed
<b>Landscape / Portrait</b>	Yes	Yes	Yes	Yes
<b>Pole Length</b>	150 cm up to 300 cm	150 cm up to 300 cm	150 cm up to 300 cm	150 cm up to 300 cm
<b>Colour (VESA Arms)</b>	Black	Black	Black	Black
<b>Colour (Horizontal Rail)</b>	Black (Silver optional)	Black (Silver optional)	Black (Silver optional)	Black (Silver optional)
<b>Colour (Poles &amp; Ceiling Mount)</b>	Black	Brass	Chrome	White
<b>Warranty</b>	5 years	5 years	5 years	5 years
<b>Accessories</b>	Cover cover	Cover cover	Cover cover	Cover cover



## MBFC2U



### Option

Use this model for back to back solutions



### MBFC2U Brass



### MBFC2U Chrome



### MBFC2U White



### SPECIFICATION FLOOR TO CEILING

Model name	MBFC2U	MBFC2U Brass	MBFC2U Chrome	MBFC2U White
<b>Recommended Screen Size</b>	32" - 65"	32" - 65"	32" - 65"	32" - 65"
<b>VESA® &amp; Non-VESA Fixings</b>	VESA400,40cm	VESA400,40cm	VESA400,40cm	VESA400,40cm
<b>Article Nr / EAN</b>	7350073733637	7350073735730	7350073735723	7350073735716
<b>Max Load</b>	50kg (TUV30kg) Per screen	50kg (TUV30kg) Per screen	50kg (TUV30kg) Per screen	50kg (TUV30kg) Per screen
<b>Bracket Type</b>	Fixed	Fixed	Fixed	Fixed
<b>Landscape / Portrait</b>	Yes	Yes	Yes	Yes
<b>Pole Length</b>	150 cm up to 300 cm	150 cm up to 300 cm	150 cm up to 300 cm	150 cm up to 300 cm
<b>Colour (VESA Arms)</b>	Black	Black	Black	Black
<b>Colour (Horizontal Rail)</b>	Black (Silver optional)	Black (Silver optional)	Black (Silver optional)	Black (Silver optional)
<b>Colour (Poles &amp; Ceiling Mount)</b>	Black	Brass	Chrome	White
<b>Warranty</b>	5 years	5 years	5 years	5 years
<b>Accessories</b>	Cover cover	Cover cover	Cover cover	Cover cover



**MBFC3U****MBFC3U Brass****MBFC3U Chrome****MBFC3U White****SPECIFICATION FLOOR TO CEILING**

Model name	MBFC3U Black	MBFC3U Brass	MBFC3U Chrome	MBFC3U White
<b>Recommended Screen Size</b>	32" - 65"	32" - 65"	32" - 65"	32" - 65"
<b>VESA® &amp; Non-VESA Fixings</b>	VESA400,40cm	VESA400,40cm	VESA400,40cm	VESA400,40cm
<b>Article Nr / EAN</b>	7350073733644	7350073735761	7350073735754	7350073735747
<b>Max Load</b>	50kg (TUV30kg) Per screen	50kg (TUV30kg) Per screen	50kg (TUV30kg) Per screen	50kg (TUV30kg) Per screen
<b>Bracket Type</b>	Fixed	Fixed	Fixed	Fixed
<b>Landscape / Portrait</b>	Yes	Yes	Yes	Yes
<b>Pole Length</b>	150 cm up to 300 cm	150 cm up to 300 cm	150 cm up to 300 cm	150 cm up to 300 cm
<b>Colour (VESA Arms)</b>	Black	Black	Black	Black
<b>Colour (Horizontal Rail)</b>	Black (Silver optional)	Black (Silver optional)	Black (Silver optional)	Black (Silver optional)
<b>Colour (Poles &amp; Ceiling Mount)</b>	Brass	Brass	Brass	White
<b>Warranty</b>	5 years	5 years	5 years	5 years
<b>Accessories</b>	Cover cover	Cover cover	Cover cover	Cover cover



## MBFC1X2U2

For back to back add items per piece :

- 7350073733668 Pole Clamp
- 7350073733866 Single Rail
- 7350073733736 Fixed arms(40cm)



## MBFC1X3U2

For back to back add items per piece :

- 7350073733668 Pole Clamp
- 7350073733866 Single Rail
- 7350073733736 Fixed arms(40cm)



## MBFC2X3U



## MBFC3X3U



Model name	MBFC1X2U2	MBFC1X3U2	MBFC2X3U	MBFC3X3U
<b>Recommended Screen Size</b>	32" - 65"	32" - 65"	32" - 65"	32" - 65"
<b>VESA® &amp; Non-VESA Fixings</b>	VESA400,40cm	VESA400,40cm	VESA400,40cm	VESA400,40cm
<b>Article Nr / EAN</b>	7350073734962	7350073734979	7350073734986	7350073734933
<b>Max Load</b>	50kg (TUV30kg) Per screen	50kg (TUV30kg) Per screen	50kg (TUV30kg) Per screen	50kg (TUV30kg) Per screen
<b>Bracket Type</b>	Fixed	Fixed	Fixed	Fixed
<b>Landscape / Portrait</b>	Yes	Yes	Yes	Yes
<b>Pole Length</b>	150 cm up to 300 cm	150 cm up to 300 cm	150 cm up to 300 cm	150 cm up to 300 cm
<b>Colour (VESA Arms)</b>	Black	Black	Black	Black
<b>Colour (Horizontal Rail)</b>	Black (Silver optional)	Black (Silver optional)	Black (Silver optional)	Black (Silver optional)
<b>Colour (Poles &amp; Ceiling Mount)</b>	Black/Brass/Chrome/White	Black/Brass/Chrome/White	Black/Brass/Chrome/White	Black/Brass/Chrome/White
<b>Warranty</b>	5 years	5 years	5 years	5 years
<b>Accessories</b>	Cover cover	7350073733668/7350073733866 /7350073733736	7350073733668/7350073733866 /7350073733736	Cover cover



## PRO SERIES

# Pole Brackets

The line up of MPro Series Pole Brackets was designed to make it simple to add a display small or large and create tailored installations with the possibility to mix both computer displays with digital signage displays in any possible way imagined. With the MPro Series Pole line of brackets it includes a variety of flexible and innovative solutions. From installing a single computer display to a row of computer displays all fitted to the MPro Series 50mm poles.

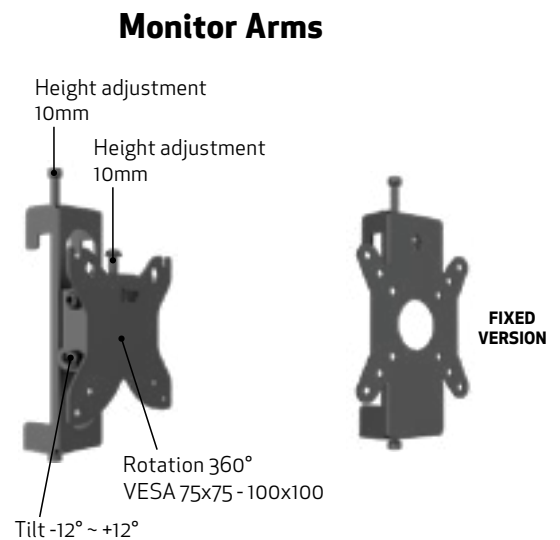
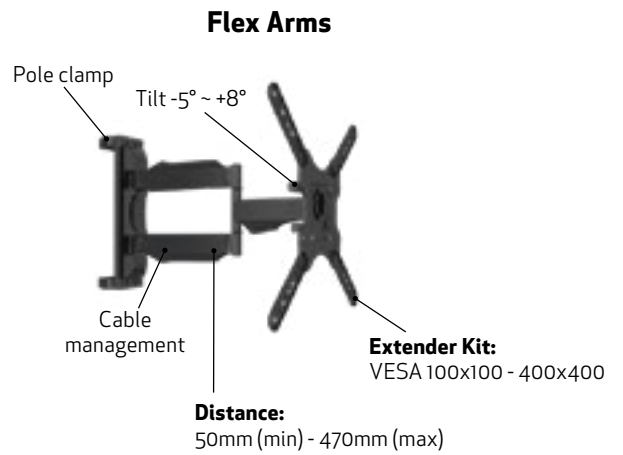
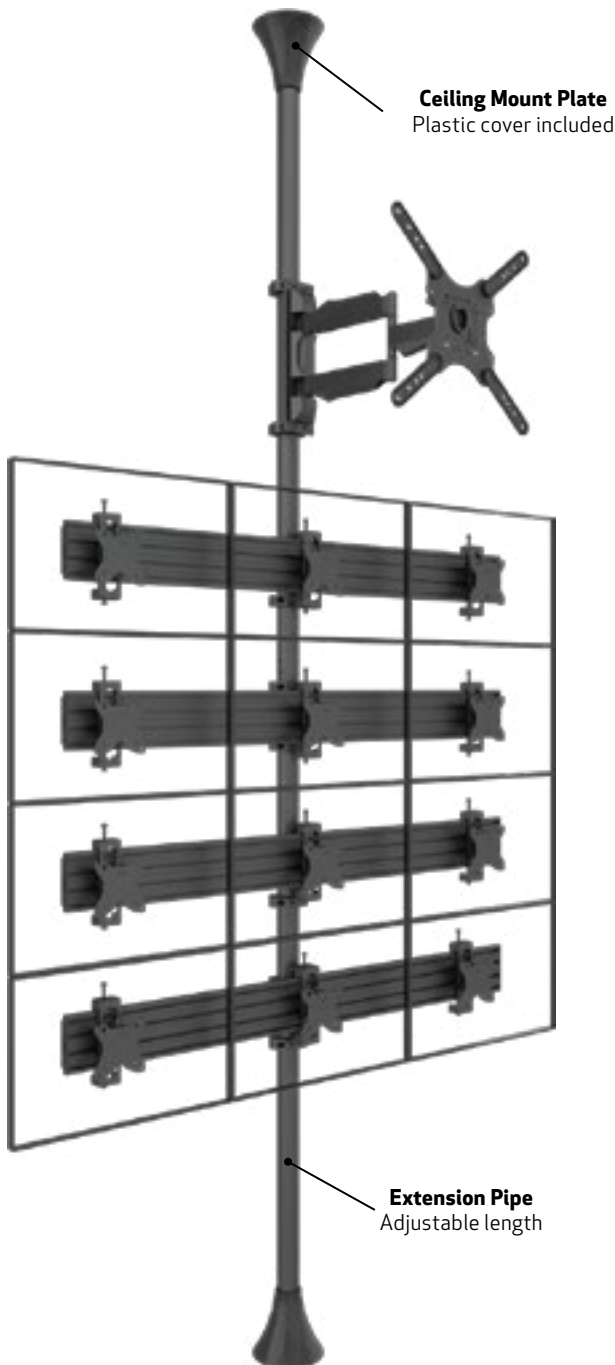

MB Pro Floor to Ceiling Mount Series is available in a wide range of models

**FLOOR TO CEILING**

for monitors

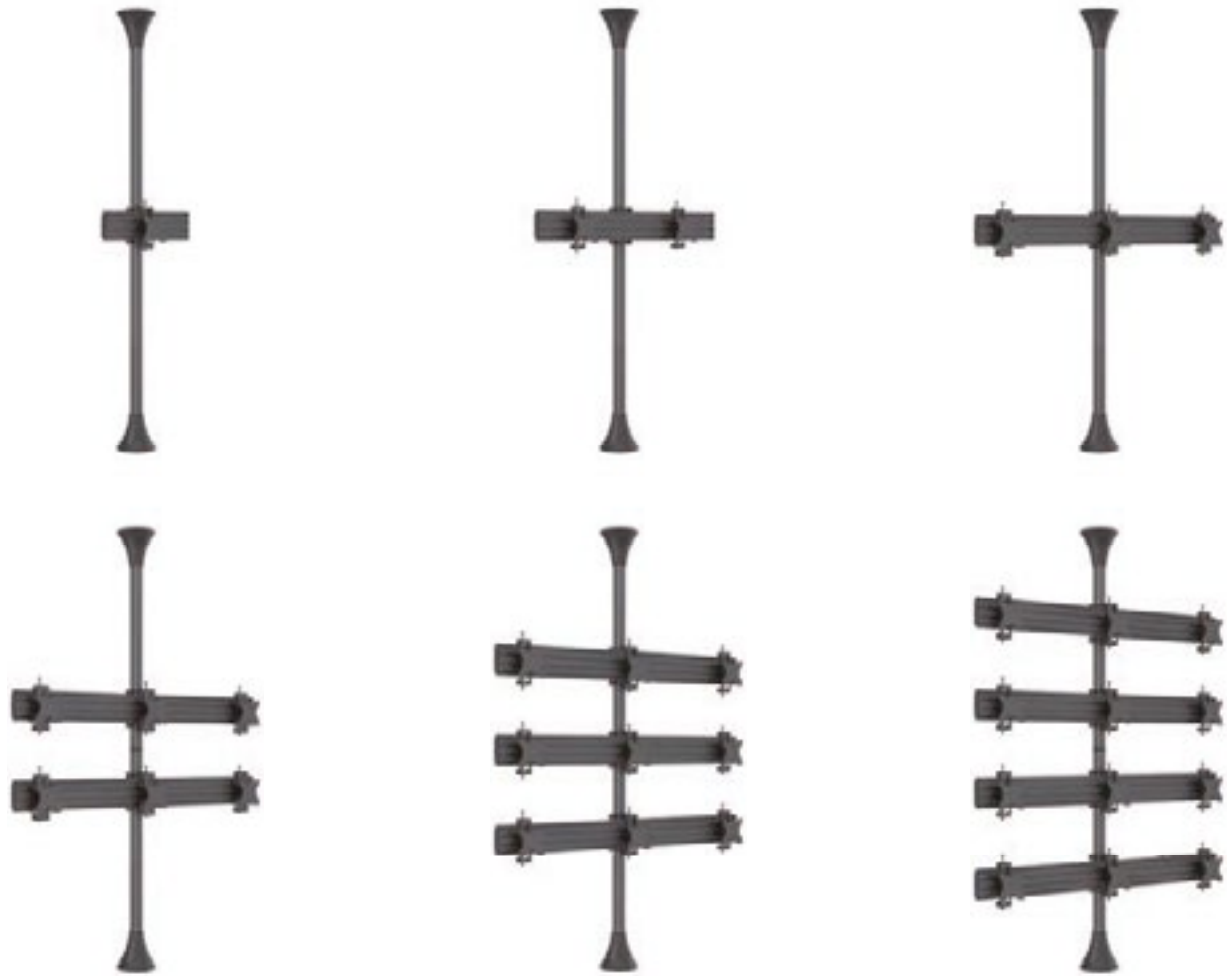

**CEILINGMOUNT**

for monitors



**WALLMOUNT**

for monitors



## Floor to Ceiling - MBFC1F VESA 200

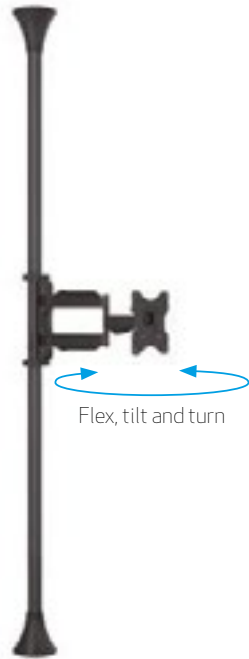

## MBFC1F



## Ceilingmount - MBFC1F VESA 200



## MBFC1F



### SPECIFICATION

Model name	MBFC1F VESA200	MBFC1F	MBC1F VESA 200	MBC1F
Recommended Screen Size	32" - 65"	32" - 65"	32" - 65"	32" - 65"
VESA® & Non-VESA Fixings	VESA 200, 40 cm	VESA400, 40cm	VESA 200, 40 cm	VESA400, 40cm
Article Nr / EAN	7350073736393	7350073736409	7350073736416	7350073736423
Max Load	50kg (TUV30kg) Per screen	50kg (TUV30kg) Per screen	50kg (TUV30kg) Per screen	50kg (TUV30kg) Per screen
Bracket Type	Tilt (-5°/+8°)	Tilt (-5°/+8°)	Tilt (-5°/+8°)	Tilt (-5°/+8°)
Swivel	180°	180°	180°	180°
Landscape / Portrait	Yes	Yes	Yes	Yes
Pole Length	150 cm up to 300 cm	150 cm up to 300 cm	150 cm up to 300 cm	150 cm up to 300 cm
Colour (VESA Arms)	Black	Black	Black	Black
Colour (Poles & Ceiling Mount)	Black/Brass/Chrome/White	Black/Brass/Chrome/White	Black/Brass/Chrome/White	Black/Brass/Chrome/White
Warranty	5 years	5 years	5 years	5 years
Accessories	Cover cover	Cover cover	Cover cover	Cover cover







# Multibrackets Wall Mounted Solutions

Our Pro Series Wallmounts can be used as menu boards or signage wallmounts. They offer a perfect display positioning and flexible adjustments. The single horizontal extrusion with optional push in pop out and depth adjustment aligns the displays very quick even on irregular mounting surfaces and allows easy access behind the displays for servicing.



## PRO SERIES

# Pro Wallmount Videowalls

For screen in a row the Pro Series now can offer you a simple way to get perfect display positioning and a choice of bracket and adjustment solutions that works after a set standard. Ensuring the very best installer experience a single aluminum extrusion rail is used with either fixed, tilt or push in pop out brackets that aligns the screens quick and efficiently.

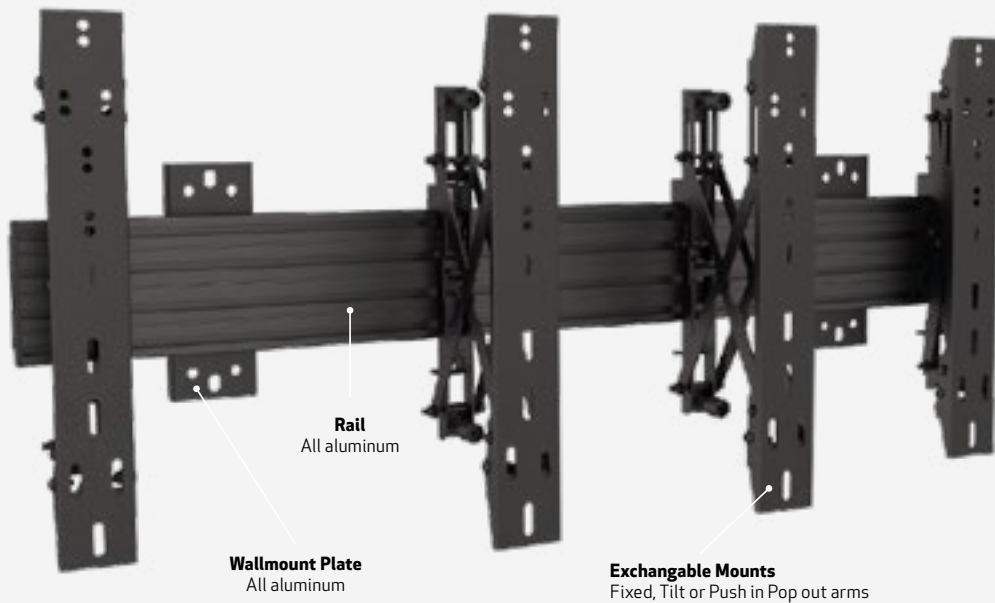

### A wide variety of arms:

- Push in pop-out:** 600/400
- Tilt:** 200/400 /600/900
- Fixed:** 200/400 /600/900
- Micro adjustable:** 200/400



Fixed



Tilt



"Push in, pop out" arms

MB Pro Wallmount / Videowall Series is available in a wide range of models

### MBW1U 48cm (Black)



### MBW1U 48cm (Silver)



### MBW1U 68cm (Black)



### MBW1U 68cm (Silver)



Portrait

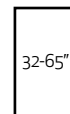

Landscape

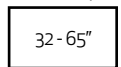

#### SPECIFICATION WALLMOUNT / VIDEOWALLS

Model name	MBW1U 48cm (Black)	MBW1U 48cm (Silver)	MBW1U 68cm (Black)	MBW1U 68cm (Silver)
Recommended Screen Size	32" - 65"	32" - 65"	32" - 65"	32" - 65"
VESA® & Non-VESA fixings	VESA400,40cm	VESA400,40cm	VESA400,40cm	VESA400,40cm
Article Nr / EAN	7350073735105	7350073735112	7350073734115	7350073734146
Max Load	40kg (TUV30kg) Per screen	40kg (TUV30kg) Per screen	40kg (TUV30kg) Per screen	40kg (TUV30kg) Per screen
Depth	5cm to 6,5cm	5cm to 6,5cm	5cm to 6,5cm	5cm to 6,5cm
Bracket Type	Push in pop out	Push in pop out	Push in pop out	Push in pop out
Landscape / Portrait	Yes	Yes	Yes	Yes
Colour (VESA Arms)	Black	Black	Black	Black
Colour (Horizontal Rail)	Black (Silver optional)	Black (Silver optional)	Black (Silver optional)	Black (Silver optional)
Colour (Poles & Ceiling Mount)	Black	Black	Black	Black
Warranty	5 years	5 years	5 years	5 years



**MBW2U (Black)****MBW2U (Silver)****MBW3U (Black)****MBW3U (Silver)****SPECIFICATION** WALLMOUNT/VIDEOWALLS

Model name	MBW2U (Black)	MBW2U (Silver)	MBW3U (Black)	MBW3U (Silver)
Recommended Screen Size	32" - 65"	32" - 65"	32" - 65"	32" - 65"
VESA® & Non-VESA Fixings	VESA400,40cm	VESA400,40cm	VESA400,40cm	VESA400,40cm
Article Nr / EAN	7350073734122	7350073734153	7350073734139	7350073734160
Max Load	30kg (Per screen)	30kg (Per screen)	30kg (Per screen)	30kg (Per screen)
Depth	5cm to 6,5cm	5cm to 6,5cm	5 cm to 6 cm	5cm to 6,5cm
Bracket Type	Push in pop out	Push in pop out	Push in pop out	Push in pop out
Landscape / Portrait	Yes	Yes	Yes	Yes
Colour (VESA Arms)	Black	Black	Black	Black
Colour (Horizontal Rail)	Black (Silver optional)	Silver (Black optional)	Black (Silver optional)	Silver (Black optional)
Colour (Poles & Ceiling Mount)	Black	Black	Black	Black
Warranty	5 years	5 years	5 years	5 years



## MBW3X2U



## MBW3X3U

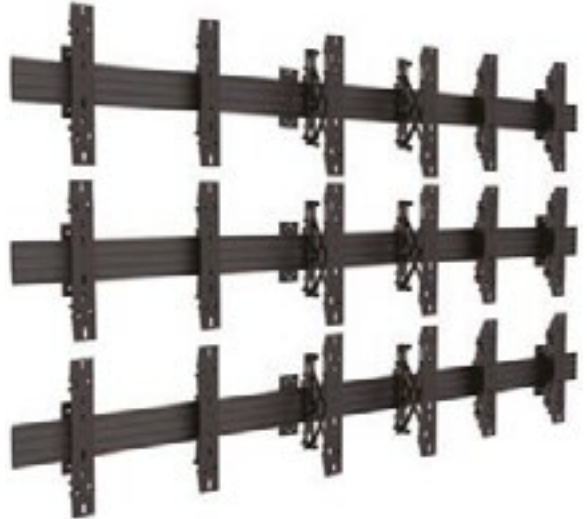

## MBW2X1UP

Portrait



## MBW3X1UP

Portrait



Landscape

32-65"

Portrait

32-65"

### SPECIFICATION WALLMOUNT / VIDEO WALLS

Model name	MBW3X2U	MBW3X3U	MBW2X1UP	MBW3X1UP
<b>Recommended Screen Size</b>	32" - 65"	32" - 65"	32" - 65"	32" - 65"
<b>VESA® &amp; Non-VESA fixings</b>	VESA400,40cm	VESA400,40cm	VESA400,40cm	VESA400,40cm
<b>Article Nr / EAN</b>	7350073735006	7350073735013	7350073735020	7350073735037
<b>Max Load</b>	40kg (TUV30kg) Per screen	40kg (TUV30kg) Per screen	40kg (TUV30kg) Per screen	40kg (TUV30kg) Per screen
<b>Depth</b>	5cm to 6.5cm	5cm to 6.5cm	5cm to 6.5cm	5cm to 6.5cm
<b>Bracket Type</b>	Push in pop out	Push in pop out	Push in pop out	Push in pop out
<b>Landscape / Portrait</b>	Yes	Yes	Yes	Yes
<b>Colour (VESA Arms)</b>	Black	Black	Black	Black
<b>Colour (Horizontal Rail)</b>	Black (Silver optional)	Black (Silver optional)	Black (Silver optional)	Black (Silver optional)
<b>Colour (Poles &amp; Ceiling Mount)</b>	Black	Black	Black	Black
<b>Warranty</b>	5 years	5 years	5 years	5 years



## MBW3X2UP

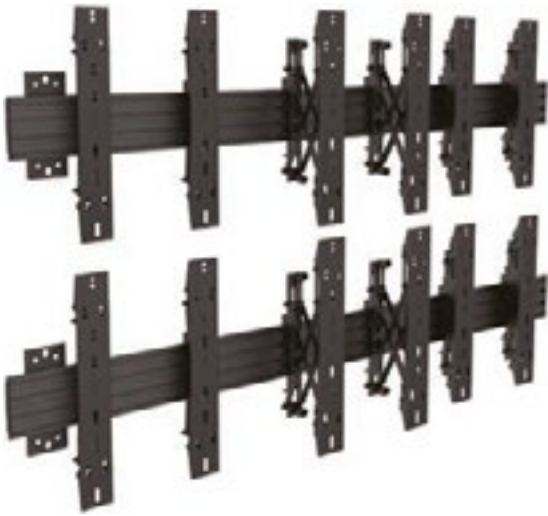

## MBW3X3UP

Portrait

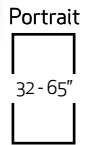

### EASY SERVICE Portrait installed screens.

With our VESA extender kits  
EAN 7350073734733  
it is easy to make easy serviced portrait  
installations.

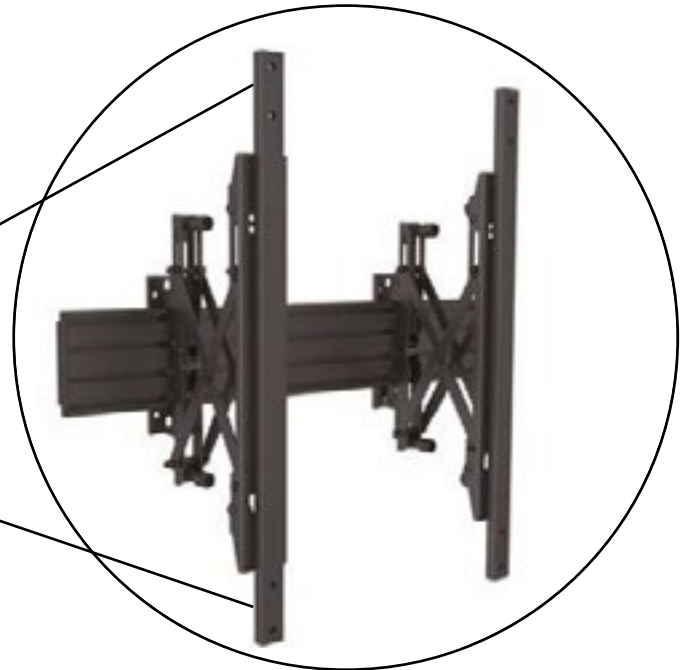

#### SPECIFICATION WALLMOUNT / VIDEO WALLS

Model name	MBW3X2UP	MBW3X3UP
Recommended Screen Size	32" - 65"	32" - 65"
VESA® & Non-VESA fixings	VESA400,40cm	VESA400,40cm
Article Nr / EAN	7350073735044	7350073735051
Max Load	40kg (TUV30kg) Per screen	40kg (TUV30kg) Per screen
Depth	5cm to 6,5cm	5cm to 6,5cm
Bracket Type	Push in pop out	Push in pop out
Landscape / Portrait	Yes	Yes
Colour (VESA Arms)	Black	Black
Colour (Horizontal Rail)	Black (Silver optional)	Black (Silver optional)
Colour (Poles & Ceiling Mount)	Black	Black
Warranty	5 years	5 years



# From Wall & Wall to Wall Series

Keep crowds informed with high visibility

In the need of solutions to mount displays in a perpendicular position to a wall ? The M Pro Series From Wall and Wall to Wall models are our innovative interior designed Pro Series solutions that offers high visibility in open areas such as hallways, concourses, aisles and office spaces. The bracket mounts vertically so that the display is presented perpendicular to walls or between two walls. The clean and simple Scandinavian design has a durable construction and is very easy to install, a complete set of hardware is included. The M Pro Series From Wall and Wall to Wall series is a single or double sided solution. This digital signage installation makes it easy to keep moving crowds informed and this type of fixture is an ideal way to display high visibility wayfinding or directional information in high traffic areas.

**MBFW1U**



**MBFW1UX2**



**MBFW1U VESA200**



**SPECIFICATION**

Model name	MBFW1U	MBFW1UX2	MBFW1U VESA200
Recommended Screen Size	32"-65"	32"-65"	17"-46"
VESA® & Non-VESA fixings	VESA400 ,40cm	VESA400 ,40cm	VESA200 ,20cm
Article Nr / EAN	7350073737642	7350073737659	7350073737666
Max Load	35kg (TUV30kg) Per screen	35kg (TUV30kg) Per screen	40kg (TUV30kg) Per screen
Bracket Type	Fixed	Fixed	Fixed
Landscape / Portrait	Yes	Yes	Yes
Colour (VESA Arms)	Black	Black	Black
Colour (Horizontal Rail)	Black (Silver optional)	Black (Silver optional)	Black (Silver optional)
Warranty	5 years	5 years	5 years



## MBWW1U



## MBWW2U



## MBWW3U



Model name	MBWW1U	MBWW2U	MBWW3U
Recommended Screen Size	32"-55"	32"-43"	32"-43"
VESA® & Non-VESA fixings	VESA400,40cm	VESA400,40cm	VESA400,40cm
Article Nr / EAN	7350073737826	7350073737833	7350073737840
Max Load	50kg (TUV30kg) Per screen	50kg (TUV30kg) Per screen	50kg (TUV30kg) Per screen
Bracket Type	Fixed	Fixed	Fixed
Landscape / Portrait	Yes	Yes	Yes
Colour (VESA Arms)	Black	Black	Black
Colour (Horizontal Rail)	Black (Silver optional)	Black (Silver optional)	Black (Silver optional)
Warranty	5 years	5 years	5 years





# DUAL SCREEN SIDE BY SIDE FOR VIDEO- CONFERENCE



Get ready to turn your clients meeting rooms into powerful cloud conferencing solutions in an instant. The new Dual Screen side by side Pro Series solution does just that. Featuring dual screen mounting with adjustable lateral shift left and right and an adjustable camera shelf to match most different screen sizes. Aimed to provide a clean modern look for a wide range of video conferencing and flat panel display applications. Ideal for boardroom and learning environments. Includes a camera shelf, soundbar holder and a complete hardware kit.

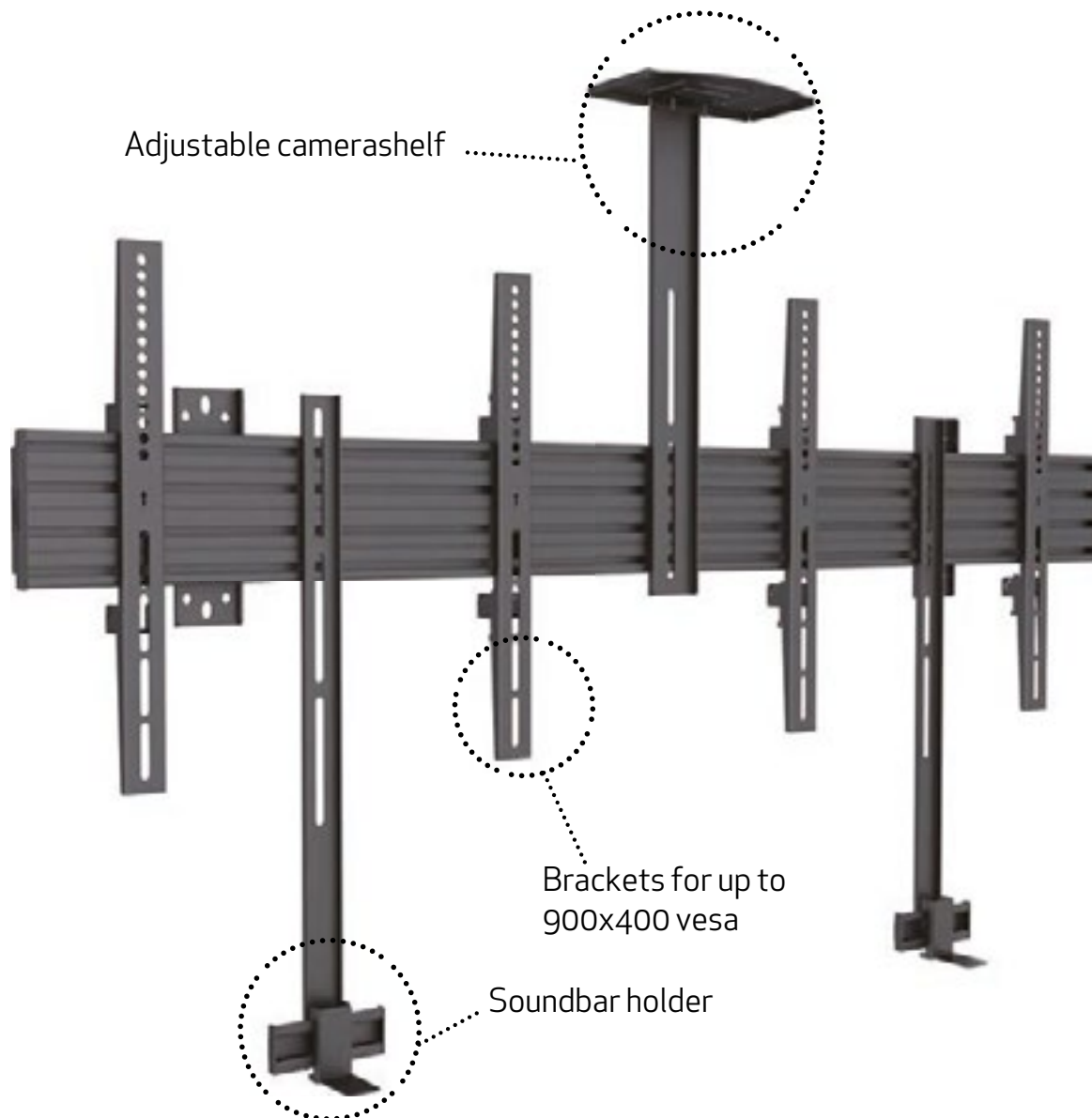

#### SPECIFICATION

Model name	Side by Side 400	Soundbar holder	Camera Shelf
Recommended Screen Size	32" - 65"	---	---
VESA® & Non-VESA fixings	VESA400,40cm	---	---
Article Nr / EAN	7350073736621	7350073736645	7350073736638
Max Load	50kg (TUV30kg) Per screen	5kg	
Bracket Type	Fixed (Tilt optional)	Fixed (Tilt optional)	Fixed (Tilt optional)
Landscape / Portrait	Yes	---	---
Material	Aluminum + Steel (SPCC Graded)	Steel (SPCC Graded)	Steel (SPCC Graded)
Colour	Black	Black	Black



# Public Videowall Mounts

*No measuring, no guessing, no mistakes.*

Video walls should be easy to configure, quick to install, and easy to maintain. Introducing the Multibrackets range of full service Video Wall Mounts. Create any configuration imaginable, but leave the tedious calculations to the custom wall plate spacers. Just install the first mount. Then use the custom wall plate spacers to perfectly place each additional mount on the wall. It couldn't be simpler.



Made  
in EU

Hergestellt nach europäischen  
Qualitätsstandards



## M Public Video Wall Mount Glide HD

M Public Video Wall Mount Glide HD might just be one of the markets most innovative and easy to install video wall mounts available.

The "Glide" feature gives easy-access to any display for quick and safe serviceability for sensitive thin bezeled displays with mm precision.

**For screen size:** 40-70"  
**Article No:** 7350073735792  
**Adjustment:** Numerous post installation possibilities  
**VESA:** 200x200,300x200,300x300,400x200,400x400  
**By adapterkit:** 600x400 and 800x400  
**Size in mm:** 760x460  
**Maxload:** 35kg  
**Weight:** 12kg



## M Public Video Wall Mount Push HD

The original video wall mount. With numerous post installation possibilities and a tailored pantograph alignment system this might be the most easy to use, yet most powerful video wall mount system you have ever seen. 8 knobs making detailed adjustments an ease, as well as easy-access to your after-service.

**For screen size:** 40-70"  
**Article No:** 7350073730568  
**VESA:** 200x200,300x200,300x300,400x200,400x400  
**By adapterkit:** 600x400 and 800x400  
**Size in mm:** 760x460  
**Maxload:** 50kg  
**Weight:** 12kg



## M Public Video Wall Mount Push HD Max 90kg

A full-service Quick Release Video Wall Mount for flat panel displays up to 95" or 90kg. With numerous post installation possibilities and a tailored pantograph alignment system this might be the most easy to use, yet most powerful video wall mount system you have ever seen. 8 knobs making detailed adjustments an ease, as well as easy-access to your after-service.

**For screen size:** 40-70"  
**Article No:** 7350073731749  
**VESA:** 200x200,300x200,300x300,400x200,400x400  
**By adapterkit:** Up to 900x600  
**Size in mm:** 760x460  
**Maxload:** 90kg  
**Weight:** 14kg



## M Public Video Wall Mount Push SD 150Kg Max

The Superduty full-service Video Wall Mount for flat panel displays up to 110" or 150kg 's. Our super duty video wall mount with post installation possibilities and a tailored pantograph alignment system this might be the most easy to use, yet most powerful video wall mount system you have ever seen.

Simple built in details to make making after adjustments more simple, as well as easy-access to your after-service even for your really large display.

**For screen size:** 50-110"  
**Article No:** 7350073734818  
**VESA:** 200x200,300x200,300x300,400x200,400x400  
**By adapterkit:** Up to 900x600  
**Size in mm:** 760x460  
**Maxload:** 150kg  
**Weight:** 14kg

**NEW!**

# Wire

Elegant and minimal wire based combinations

Make a strong design statement with these spectacular wire based mounts. Now you can hang your screen in wires using the Pro Series wire based system. All parts utilized is the standard Pro Series items but you also add the wires to hang the screen in position.

Use single screen or back to back installations.

Treat your clients stores to a visual make over with these elegant and minimal wire based combinations. Designed to combine style with functionality, these displays can easily set up in most stores with a major wow factor.



## SPECIFICATION

Model name	M Pro Series Wire 300	M Pro Series Wire 600
Recommended Screen Size	32" - 65"	32" - 65"
VESA® & Non-VESA fixings	VESA400 ,40cm	VESA400 ,40cm
Article Nr / EAN	7350073736959	7350073736966
Max Load	25kg (Per screen)	25kg (Per screen)
Bracket Type	Fixed (Tilt optional)	Fixed (Tilt optional)
Landscape / Portrait	Yes	Yes
Wire Length	300cm	600cm
Material	Aluminum + Steel (SPCC Graded)	Aluminum + Steel (SPCC Graded)
Colour (VESA Arms)	Black	Black
Colour (Wire)	Chrome	Chrome
Colour	Black	Black
Warranty	5 years	5 years



**M Pro Series Wire**

**M Pro Series Wire Back to Back**



up to  
600cm

**NEW!**

**PRO SERIES**

*FLOORSTANDS*

## Single Pole Series

The new range of Pro Series single pole flat panel floorstand 's are designed to provide the ideal display viewing placement and match the décor of any environment. Ideal for public areas like stores, training rooms, lobbies, classrooms, auditoriums, or exhibition halls. As with all Pro series products a full line-up of accessories offering tailor possibilities functionality to meet your specific requirements. Internal cable management hides the AV cabling, showing a clean look.

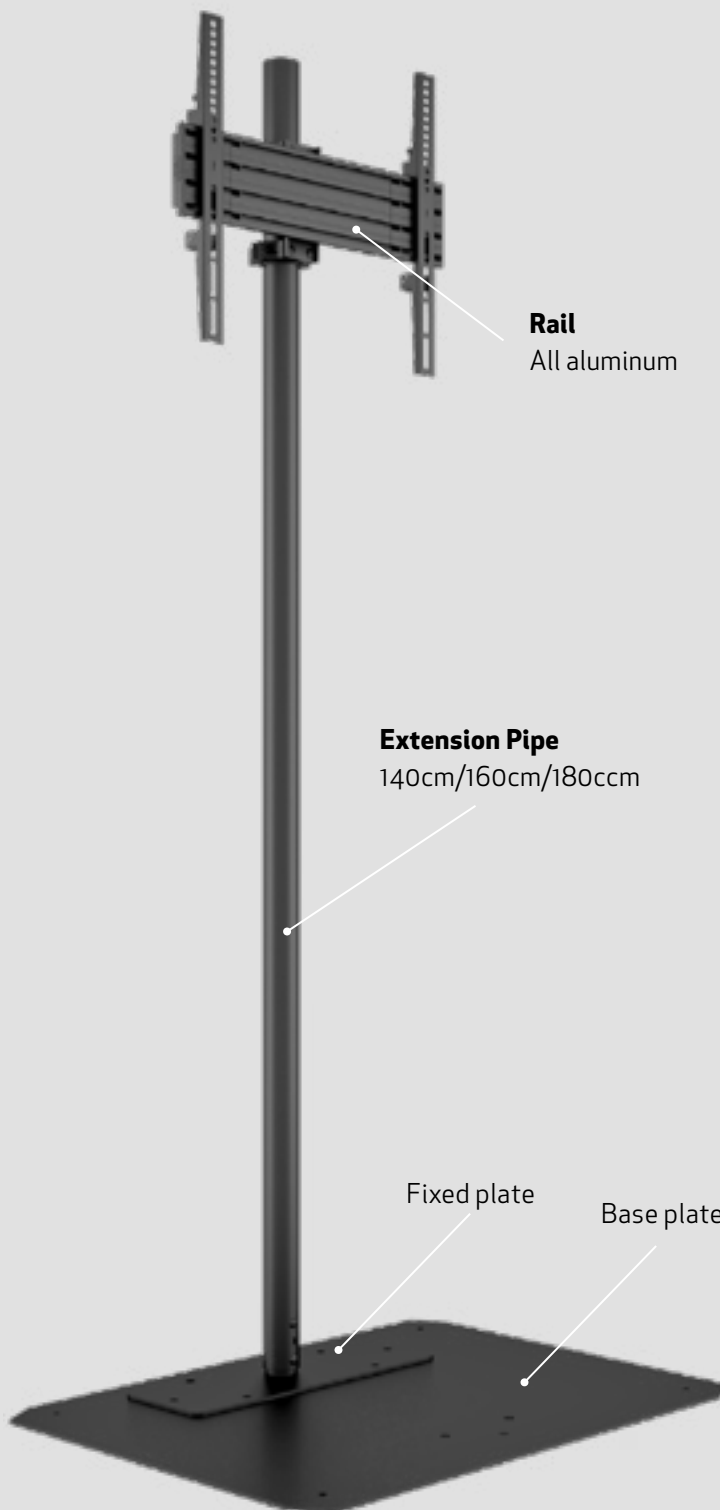

Optional round base

MB Pro Single Pole Series is available in a wide range of models

**SINGLE POLE FLOORMOUNT(BLACK)**



**SINGLE POLE FLOORBASE(BLACK)**



**SINGLE POLE FLOORMOUNT(CHROME)**



**SINGLE POLE FLOORBASE(CHROME)**



**SINGLE POLE FLOORMOUNT(WHITE)**



**SINGLE POLE FLOORBASE(WHITE)**



**NEW!**

**PRO SERIES**

*FLOORSTANDS*

## Dual Pole Series

The Dual Pole range of Pro Series floorstand 's designed to support one or two large size screens mounted back-to-back in either landscape or portrait. Simple to install, clean and attractive design, yet very robust and functional the Dual Pole series is ideal for a wide variety of applications and settings. Designed to provide the ideal display viewing placement and match the décor of any environment. Ideal for public areas like stores, training rooms, lobbies, classrooms, auditoriums, or exhibition halls. As with all Pro series products a full line-up of accessories offering tailor possibilities functionality to meet your specific requirements. Internal cable management hides the AV cabling, showing a clean look.

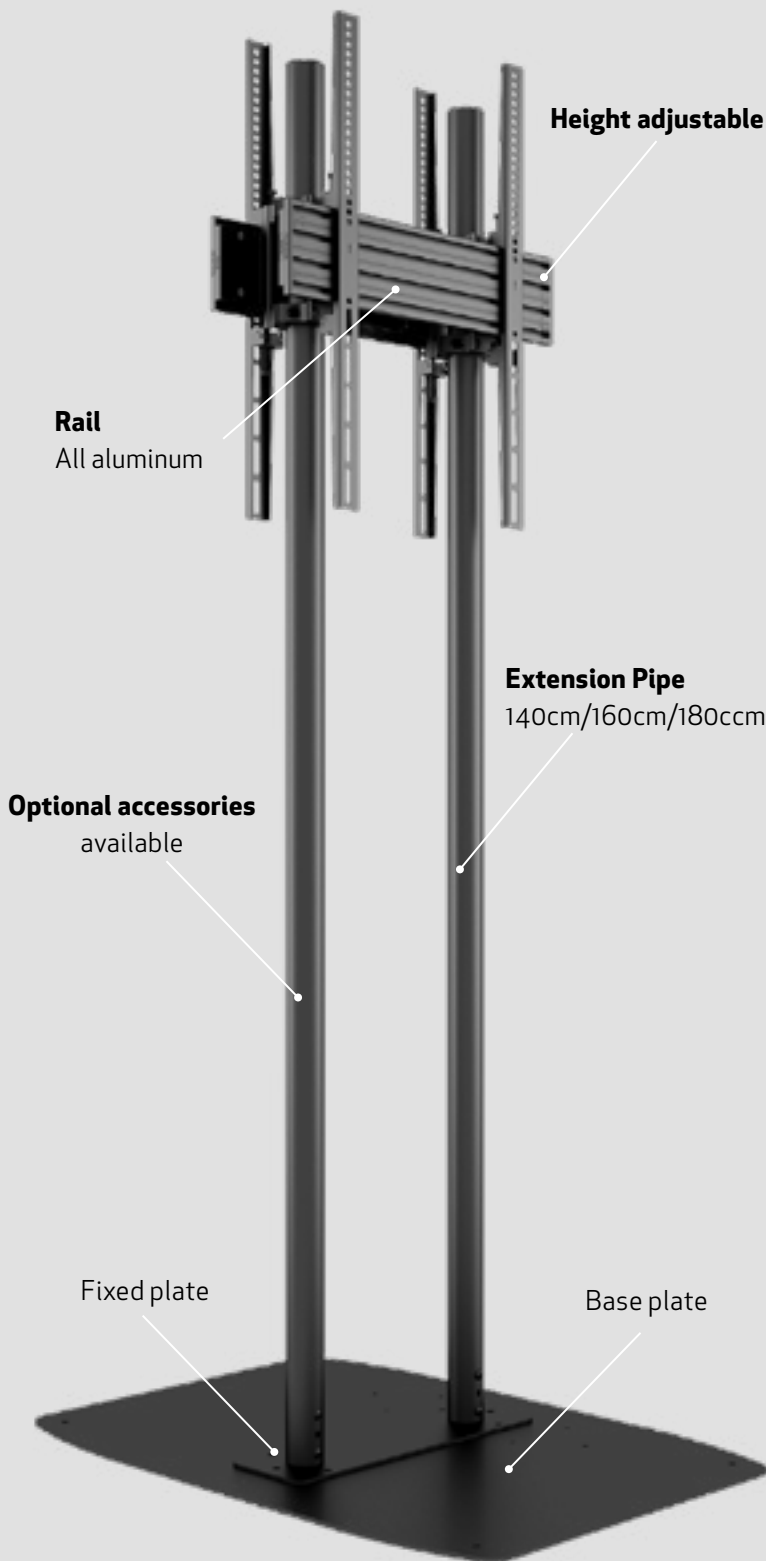

MB Pro Dual Pole Series is available in a wide range of models



## DUAL POLE FLOORMOUNT



## DUAL POLE FLOORBASE



## DUAL POLE FLOORMOUNT BACK TO BACK



## DUAL POLE FLOORBASE BACK TO BACK



Model name	Single Pole Floormount	Single Pole Floorbase	Dual Pole Floormount	Dual Pole Floorbase	Dual Pole Floormount B2B	Dual Pole Floorbase B2B
<b>Recommended screen size</b>	32" - 65"	32" - 65"	65" - 90"	65" - 90"	65" - 90"	65" - 90"
<b>VESA &amp; Non-VESA fixings</b>	400x400	400x400	800x400	800x400	800x400	800x400
<b>Article Nr / EAN</b>	TBD	TBD	TBD	TBD	TBD	TBD
<b>Max Load</b>	50 Kg	50 Kg	75 Kg	75 Kg	100 Kg	100 Kg
<b>Bracket type</b>	VESA	VESA	VESA	VESA	VESA	VESA
<b>Landscape / Portrait</b>	Yes	Yes	Yes	Yes	Yes	Yes
<b>Pole height (cm)</b>	145/160/180	145/160/180	180/Customized	180/Customized	180/Customized	180/Customized
<b>Colour options</b>	Black/Chrome/White	Black/Chrome/White	Black/Chrome/White	Black/Chrome/White	Black/Chrome/White	Black/Chrome/White
<b>Warranty</b>	5 years	5 years	5 years	5 years	5 years	5 years
<b>Accessories</b>	Yes (optional)	Yes (optional)	Yes (optional)	Yes (optional)	Yes (optional)	Yes (optional)

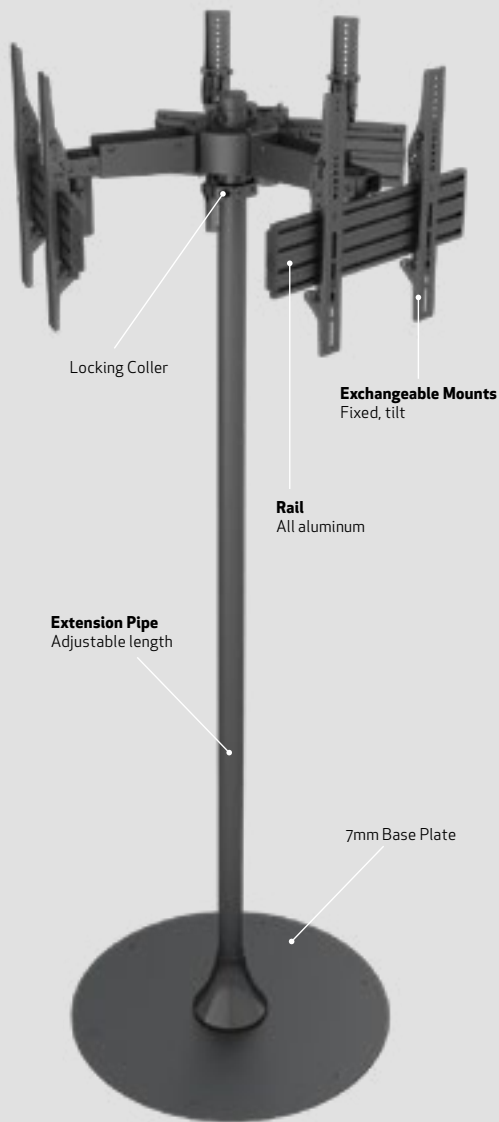

**NEW!**

**PRO SERIES**

FLOORSTANDS

# Pole Series

At Multibrackets we have a constant strive to improve the versatility and ease of use of our products. Listening to the feedback from installers and integrators it was apparent that the market requires a product range that can fulfill multiple requirements from a limited number of SKUs, our Pro Series was born. Pro Series is a truly Modular Series allowing the professional installer to configure their own bespoke flat panel or projector mounting solution.

**Tai/or Made**

Floorstand - Pro Series - Pole Series

With the unique modular set up the Pro Series range of floorstand 's designed to support one, two, three or more screens mounted in most ways imaginable in either landscape or portrait. Simple to install, clean and attractive design, yet very robust and functional the Dual Pole series is ideal for a wide variety of applications and settings. Designed to provide the ideal display viewing placement and match the décor of any environment. Ideal for public areas like stores, training rooms, lobbies, classrooms, auditoriums, or exhibition halls. As with all Pro series products a full line-up of accessories offering tailor possibilities functionality to meet your specific requirements. Internal cable management hides the AV cabling, showing a clean look.

MB Pro Floorstand Series is available in a wide range of models

**Triple Pro MBF3U****Triple Pro AddOn MBF3U****Quad Pro MBF4U****Quad Pro AddOn MBF4U****SPECIFICATION**

Model name	Triple Pro MBF3U	Triple Pro AddOn MBF3U	Quad Pro MBF4U	Quad Pro AddOn MBF4U
Recommended Screen Size	32"-65"	32"-65"	32"-65"	32"-65"
VESA® & Non-VESA fixings	VESA400,40cm	VESA400,40cm	VESA400,40cm	VESA 400x400
Article Nr / EAN	7350073737697	7350073737703	7350073737710	7350073737727
Max Load	50kg (TUV30kg) Per screen	50kg (TUV30kg) Per screen	50kg (TUV30kg) Per screen	50kg (TUV30kg) Per screen
Bracket Type	Tilt	Tilt	Tilt	Tilt
Landscape / Portrait	Yes	Yes	Yes	Yes
Colour (VESA Arms)	Black	Black	Black	Black
Colour (Horizontal Rail)	Black (Silver optional)	Black (Silver optional)	Black (Silver optional)	Black
Warranty	5 years	5 years	5 years	5 years
Accessories	Cover plate	Cover plate	Cover plate	Cover plate



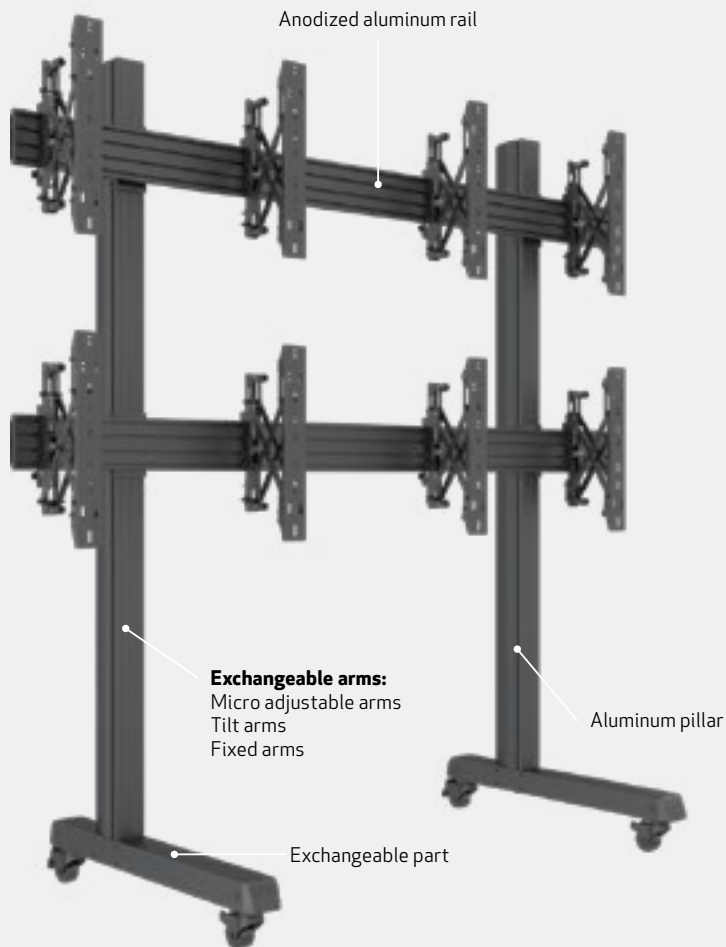

**NEW!**

**PRO SERIES**

# Free Standing Series

Create your own video wall & interact with the consumer

## EXCHANGABLE PARTS:

---



4" lockable casters



Adjustable Pro Feet



Fixed Pro Floorbase

MB Pro Free Standing Series is available in a wide range of models

**NEW!**

# Menu Boards for *Curved Screens*

The line up of M Pro Series Pole Brackets was designed to make it simple to add a display small or large and create tailored installations with the possibility to mix both computer displays with digital signage displays in any possible way imagined. With the M Pro Series Pole line of brackets it includes a variety of flexible and innovative solutions. From installing a single computer display to a row of computer displays all fitted to the M Pro Series 50mm poles. So start create any mixed solutions containing monitor displays and large size displays with tilt and turn possibilities. All the Pro Series Pole Brackets can be after installed or one can use one of our already configured products. Start utilizing our clean and simple Scandinavian designed brackets with durable construction and easy installation. A complete set of hardware is always included.

- ✓ Works with most curved screens the market has to offer.
- ✓ Fast & accurate assembly & installation.
- ✓ Easy & smooth push in pop out, or fixed installations.
- ✓ Simple access & quick rear service.

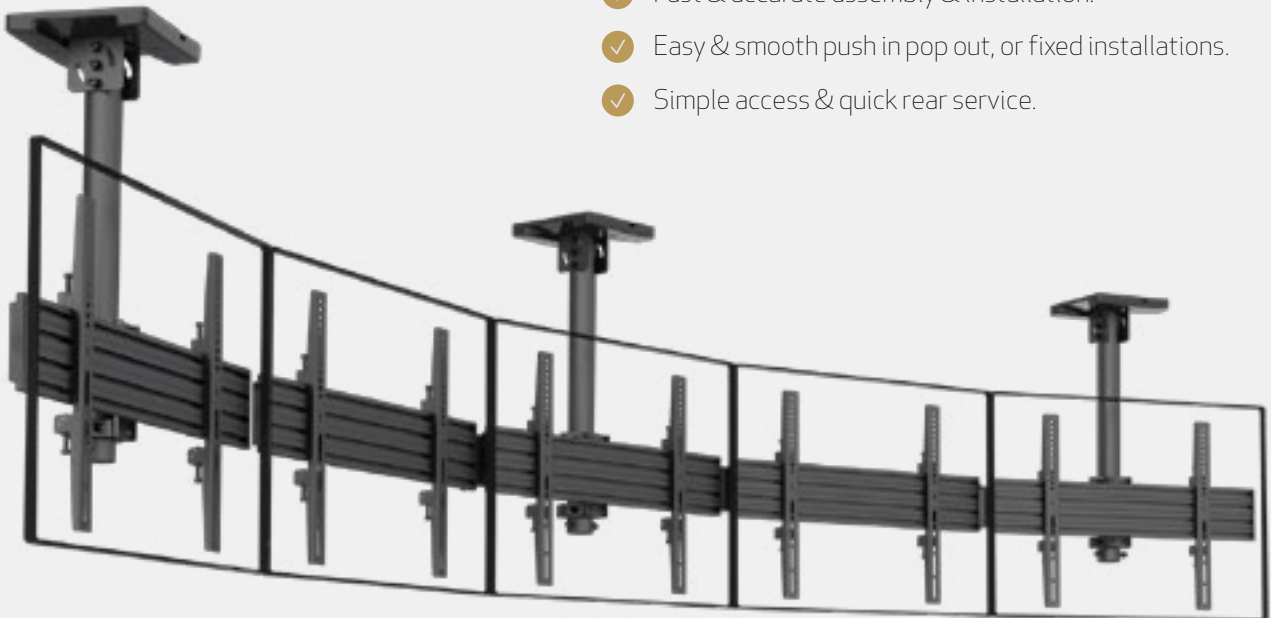

## **CURVED SCREEN RAIL JOINER**

**EAN:** 7350073736348

**Turn:** -45° ~ +45°

**Distance adjustment:** 0 ~ 200 mm



MB Pro Menu Boards Series is available in a wide range of models

# Create curved solutions with Pro Series

**Floor to Ceiling**

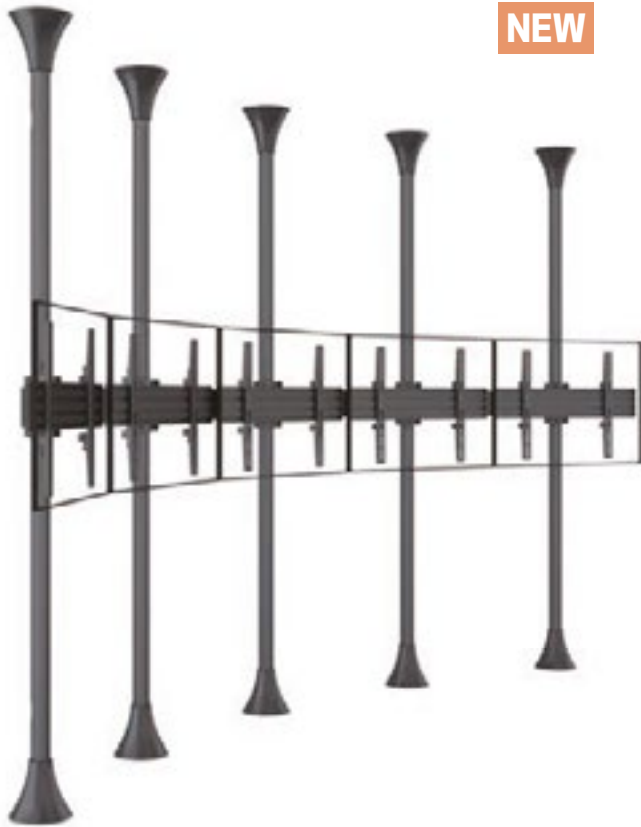

**Ceilingmount**



**Menu Boards**



**Floor stands**



# Keep your monitors protected from theft

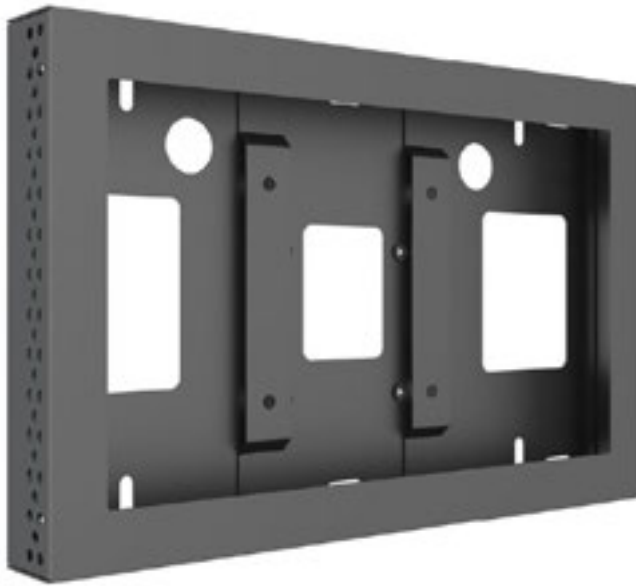

Anti theft

## M Pro Series Enclosure QB13R & QB13R-T

Keep your Samsung QB13R or QB13R-T easy accessible and well protected. Perfect in public or industrial indoor environments the brand new M Pro Series Enclosure QB13R & QB13R-T is targeted to keep your displays safe. Designed to accommodate QB13R or QB13R-T the M Pro Series Enclosure QB13R & QB13R-T carefully safeguards your display permitting placement in public environments.



**SAMSUNG** Models: QB13R & QB13R-T

**Article No:** 7350 073 738 519

**Colour:** Black

**Material:** Steel

**Surface Finish:** Powder coating

**VESA standard:** 100x100 mm

**Measurements:** 39.2x26.2x5cm

**Installation:** for Samsung screen QB13R & QB13R-T

**Weight:** 2 kg

**Max load:** 10 kg

**Warranty:** 5 years

### Highlights:

- Solid steel construction
- Encloses a small screen in a steel cage to protect from theft
- Simple to use in combination with the Samsung QB13R & QB13R-T series screens
- Locks with security screws
- Open air design provides the screen to ventilate at the similar level as when not using the cage.

## MULTIBRACKETS PRO SERIES M WALLMOUNT PRO MBSTH1U:

This is our innovative - ready to be installed Single-Display Wallmount.

This mount is suited for Ultra-Stretch Digital Signage screens like LG's.



**NEW!**

# Ultra Stretch

Stretch your digital signage installations.

With Multibrackets Pro Series you carry bracket solutions for most stretched displays on the market. Expand your digital signage installations and business limits with stretched monitor displays. Now you can present information, advertisements and branding in a new way, shape and form with stretched displays and our brackets distinctively versatile.

### **VESA:**

600x400

400x600

600x200

200x600







Image courtesy of LG C

# Ultra-Stretch Digital Signage

## PRO SERIES

Customized for

# LG<sup>®</sup>

L86BH5C



- A flexible system product ideal for video walls and menuboards
- Includes VESA adapters for compatibility up to VESA 200x600 / 600x200
- Module based aluminum rails creates desirable length without cutting
- Integrated cable management throughout the entire solution
- Power click install for an easy, fast and safe installation
- Dual wallplates included
- Portrait or landscape position of screen possible
- Hardware kit included

## SPECIFICATION

Model name	NEW LG MBSTH1U (STANDING)	NEW LG MBSTH1UP (LANDSCAPE)
Recommended Screen Size	40" - 100" stretched	40" - 100" stretched
VESA <sup>®</sup> & Non-VESA fixings	VESA 200x600	VESA 600x200
Article Nr / EAN	7350073734306	7350073734313
Max Load	30kg (Per screen)	30kg (Per screen)
Bracket Type	Fixed (Tilt optional)F	Fixed (Tilt optional)
Landscape / Portrait	Yes	Yes
Colour (VESA Arms)	Black	Black
Colour (Horizontal Rail)	Black (Silver optional)	Black (Silver optional)
Colour (Poles & Ceiling Mount)	Black	Black
Warranty	5 years	5 years

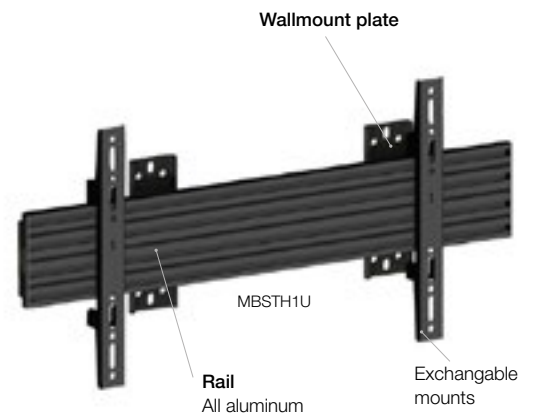

MBSTH1UP



Image courtesy of Samsung Corp

**PRO SERIES**

Customized for

# SAMSUNG®

OM55N-D / OM46N-D

- Ceilingmounts and floormounts dedicated to present bright content on a dual-display
- Modernizes and saves store space with its flexible design, offers more room to market your brand or products
- Dedicated side mounting points compatible with Samsung OMND back-to-back display models
- Highest level of finish to any client branding, bespoke colors available on request
- Semi Concealed hardware for sleek & stylish aesthetics
- A standalone floor base is optional
- Durable design, Multibrackets well known quality of materials and production process
- Complete hardware kit included



## PRO SERIES

# MB Pro Series OM55N-D / OM46N-D



Floorbase



Wheelbase



Ceilingmount



Ceilingmount  
with extension kit

Made for

**SAMSUNG**

These days many installers get the request to promote content with exceptional clarity in any storefront window. Multibrackets series of customized Floor or Ceiling Mounts for Samsung OMND display series is the ideal digital signage mounting solution for store windows. The Samsung OMN-D Series features a double-sided screen, with each side adjusted for the environments in which it is utilized. Samsung's OMN-D Series can be easily mounted on a stand or hung from a ceiling, giving retailers more options for positioning. The smart design creates a clean look and offers flexibility in how valuable floor space is designed and utilized.

The MFloormount Pro OM55N-D is the floormount designed for Samsung two sided screen OM55N-D. This dedicated mount allows businesses to create a platform for eye-catching content deliveries on a minimalistic mounting solution. By many installers considered the ideal display and mount solution for store window applications. A minimum of visible cables and screws from the outside. With a multitude of installer friendly features including concealed cable management for a professional appearance. This is an incredibly versatile solution that can be adapted to suit a wide range of both retail and commercial applications.

## M Floormount Pro OM46N-D



## M Floorbase OM46N-D



## 7529 + 7512



## M Ceiling Mount Pro OM46N-D



Model name	M Floormount Pro OM46N-D	M Floorbase OM46N-D	7529+7512	M Ceiling Mount Pro OM46N-D
Recommended Screen Size	SAMSUNG OM46N-D	SAMSUNG OM46N-D	SAMSUNG OM46N-D	SAMSUNG OM46N-D
Article Nr / EAN	7350073737529	7350073737512	7350073737529+7350073737512	7350073737536
Max Load	50kg (Per screen)	50kg (Per screen)	50kg (Per screen)	50kg (Per screen)
Bracket Type	Fixed	Fixed	Fixed	Tilt
Colour	Black	Black	Black	Black
Warranty	5 years	5 years	5 years	5 years

## M Floormount Pro OM55N-D



7529+ 7512

## M Floorbase OM55N-D



## M Ceiling Mount Pro OM55N-D



## M Wiremount Pro OM55N-D



## M Wheelbase OM55N-D



<b>Model name</b>	<b>M Floormount Pro OM55N-D</b>	<b>M Floorbase OM55N-D</b>	<b>7369+7352</b>	<b>M Ceiling Mount Pro OM55N-D</b>
<b>Recommended Screen Size</b>	SAMSUNG OM55N-D	SAMSUNG OM55N-D	SAMSUNG OM55N-D	SAMSUNG OM55N-D
<b>Article Nr / EAN</b>	7350073737369	7350073737352	7350073737369+7350073737352	7350073737376
<b>Max Load</b>	50kg (Per screen)	50kg (Per screen)	50kg (Per screen)	50kg (Per screen)
<b>Bracket Type</b>	Fixed	Fixed	Fixed	Tilt
<b>Colour</b>	Black	Black	Black	Black
<b>Warranty</b>	5 years	5 years	5 years	5 years
<b>Model name</b>	<b>M Floormount Pro OMND</b>	<b>M Wheelbase OM55N-D</b>		
<b>Recommended Screen Size</b>	SAMSUNG OM55ND	SAMSUNG OM55ND		
<b>Article Nr / EAN</b>	7350073737468	7350073737475		
<b>Max Load</b>	50kg (Per screen)	50kg (Per screen)		
<b>Bracket Type</b>	Fixed	Fixed		
<b>Colour</b>	Black	Black		
<b>Warranty</b>	5 years	5 years		





Image courtesy of Samsung Corp

Image courtesy of LG Corp

**PRO SERIES**  
**LED Wallmounts**  
**for SAMSUNG**

**IER series: SAMSUNG**

**NEW**

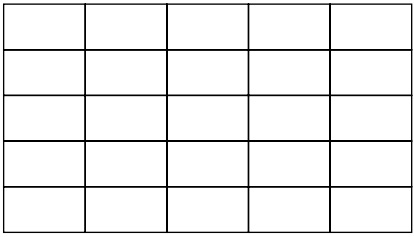

5x5

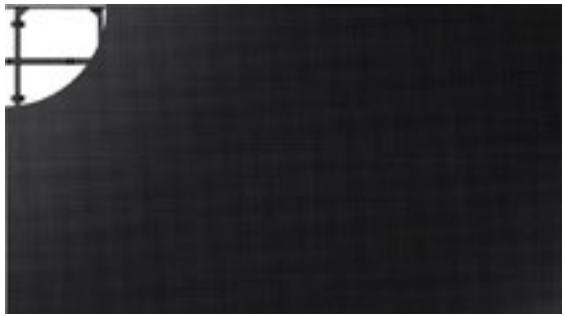

**NEW**

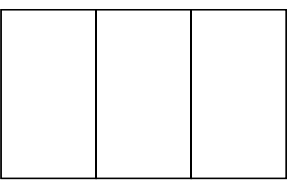

3x1

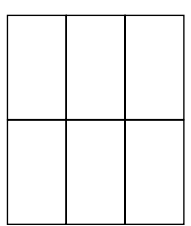

1x1, 3x3, 5x5, 10x10, 20x20

**Tai/er Made**

"Customized LED video walls for your needs"

# PRO SERIES LED Wallmounts for LG



Image courtesy of LG Corp

LAS series:  LG

NEW

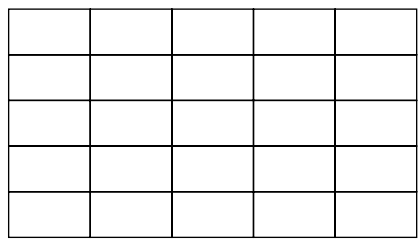

5x5

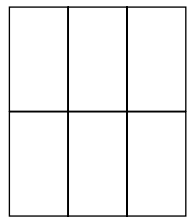
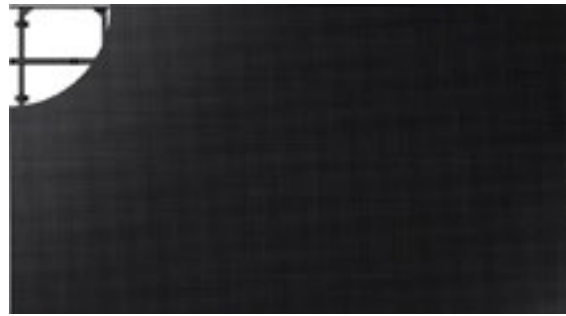

1x1, 3x3, 5x5, 10x10, 20x20

**Tai/or Made**

"Customized LED video walls for your needs"

	MB Ledmount for Samsung IER Series	MB Ledmount for LG LAS Series
<b>Model name:</b>	MB Ledmount for Samsung IER Series	MB Ledmount for LG LAS Series
<b>Non Vesa Fixing:</b>	Tailor made	Tailor made
<b>Article Nr / EAN:</b>	TBD	TBD
<b>Max Load:</b>	Tailor made for Samsung IER Series	Tailor made for LG LAS Series
<b>Bracket type:</b>	Fixed	Fixed
<b>Landscape / Portrait:</b>	Yes	Yes
<b>Fine tune adjustment:</b>	Yes, 3-axis	Yes, 3-axis
<b>Quick install:</b>	Yes	Yes
<b>Warranty:</b>	5 years	5 years



Image courtesy of BenQ Corp

**PRO SERIES**

Customized for

**BENQ**®

BH2801 / BH3801

**Ideal for  
Point of Sale  
marketing**

Ideal for point-of-sale marketing for advertising above shelves or in other limited spaces, offering maximal screen size and message impact in convenient long-and-narrow form factors.

Pro Series have packed solutions specifically designed to accommodate the Ultra Stretch Digital Signage screens. Using simple Pro Series installation and minimalistic design, the MB Pro Series stretched bracket solutions is fit to match most stretched screens in retail, commercial or hospitality settings.

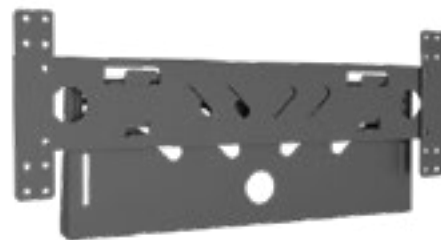

BH2801 / BH3801



BH2401 / BH3501

**SPECIFICATION**

Model name	Ceiling Mount Pro BH2401	Ceiling Mount Pro BH2801
Recommended Screen Size	BENQ BH2401 and BH3501	BENQ BH2801 and BH3801
Article Nr / EAN	7350073737499	7350073737505
Max Load	15kg	15kg
Bracket Type	FixedF	ixed
Landscape / Portrait	Yes	Yes
Colour	Black	Black
Warranty	5 years <sup>5</sup>	years







# Promote storefront content

## PRO SERIES

Customized for

# PHILIPS®

32BDL-4050D / 49BDL-4050D

- Ceiling mounts dedicated to present bright content on dual Philips displays in aisles and other open store spaces
- Modernizes and saves store space with its flexible design, offers more room to market your brand or products
- Dedicated side mounting points compatible with Philips display models
- Highest level of finish to any client branding, bespoke colors available on request
- Semi Concealed hardware for sleek & stylish aesthetics
- A standalone floor base is optional
- Durable design, Multibrackets well known quality of materials and production process
- Complete hardware kit included

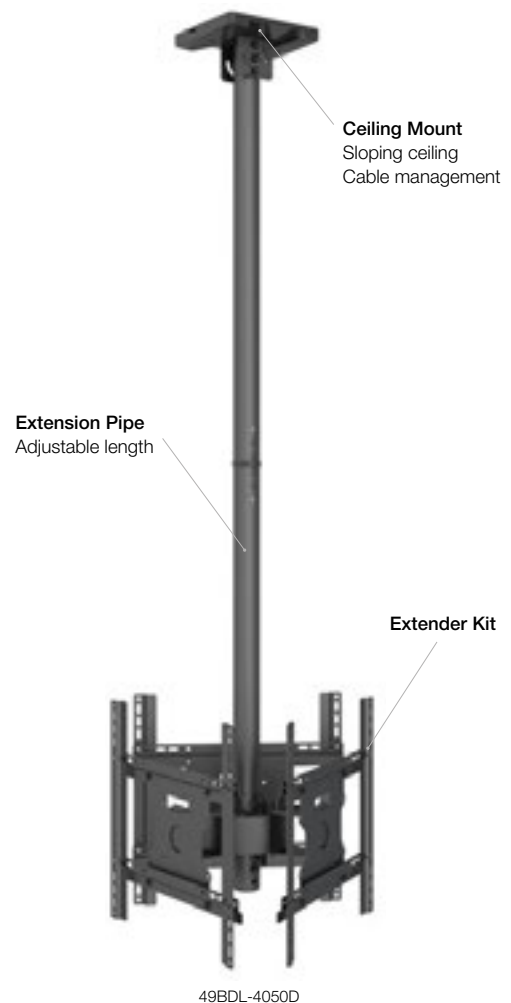



**Get full  
product  
attention**

**PRO SERIES**

Customized for

**PHILIPS**®

49BDL-4050D

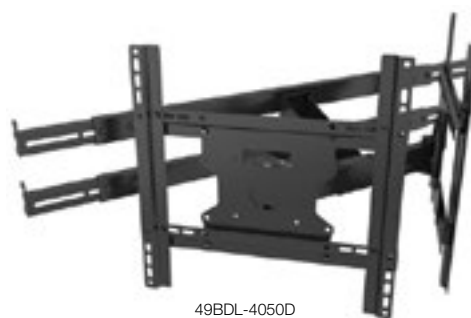

- Wallmounts dedicated to present bright content through dual Philips displays at the end of an aisle shelf system
- Modernizes and saves store space with its flexible design, offers more room to market your brand or products
- Dedicated side mounting points compatible with Philips display models
- Highest level of finish to any client branding, bespoke colors available on request
- Semi Concealed hardware for sleek & stylish aesthetics
- Durable design, Multibrackets well known quality of materials and production process
- Complete hardware kit included

## M Ceiling Mount Pro Dual 32BDL-4050D



## M Ceiling Mount Pro Triple 32BDL-4050D



## M Ceiling Mount Pro Dual 49BDL-4050D



## M Ceiling Mount Pro Triple 49BDL-4050D



### Dual 32BDL-4050D



### Dual 49BDL-4050D



Model name	Dual 32BDL-4050D	Triple 32BDL-4050D	Dual 32BDL-4050D	Dual 49BDL-4050D	Dual 32BDL-4050D	Dual 49BDL-4050D
Recommended screen size	32"	32"	49"	49"	32"	49"
VESA & Non-VESA fixings	VESA 200x200	VESA 200x200	VESA 400x400	VESA 400x400	VESA 200x200	VESA 400x400
Article Nr / EAN	7350073737543	7350073737550	7350073737574	7350073737581	7350073737567	7350073737598
Max Load	30kg (Per screen)	30kg (Per screen)	30kg (Per screen)	30kg (Per screen)	30kg (Per screen)	30kg (Per screen)
Bracket type	Fixed	Fixed	Fixed	Fixed	Fixed	Fixed
Pole length	80 - 150 cm	80 - 150 cm	80 - 150 cm	80 - 150 cm	-	-
Landscape / Portrait	-	-	-	-	Yes	Yes
Colour (VESA Arms)	Black	Black	Black	Black	Black	Black
Colour (Horizontal Rail)	-	-	-	-	Black	Black
Colour (Poles & ceiling mount)	Black	Black	Black	Black	Black	Black
Warranty	5 years	5 years	5 years	5 years	5 years	5 years
Accessories	Cover plate	Cover plate	Cover plate	Cover plate	Cover plate	Cover plate



# PRO SERIES DETAILS

## Rail gives installers function & freedom

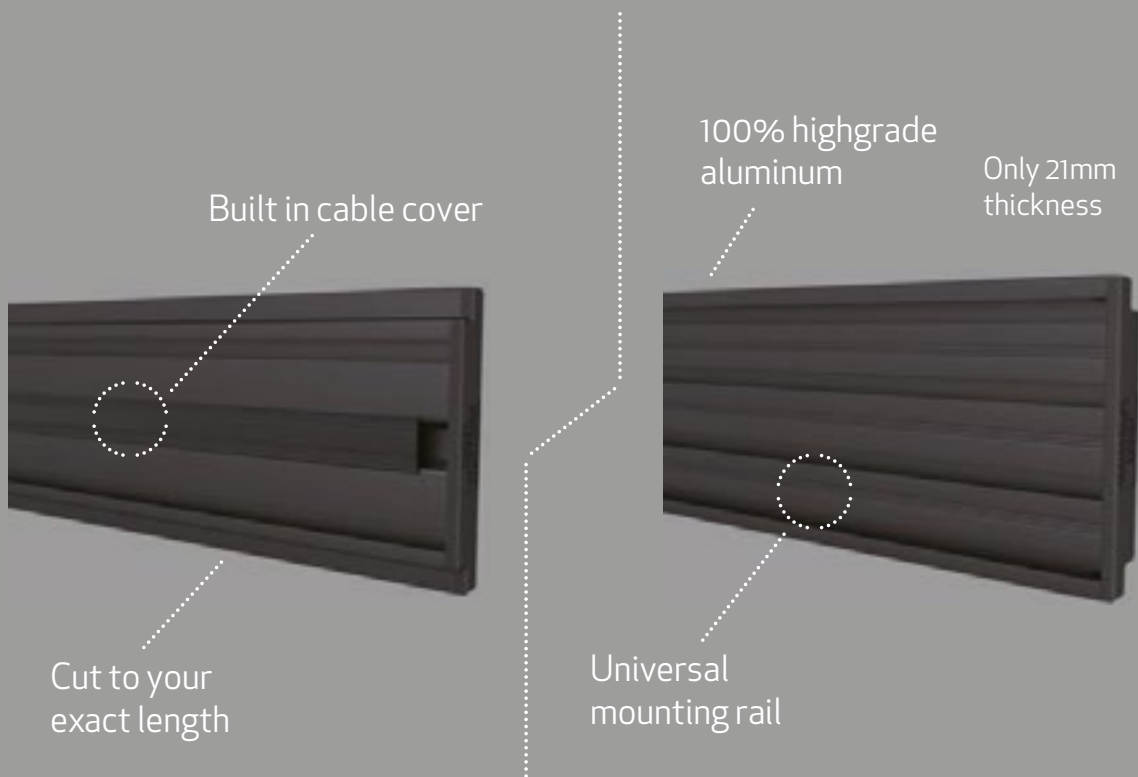

## M Wallmount Column



<b>Model name</b>	Pro Series - M Wallmount Column
<b>Article No:</b>	7 350 073 738 458
<b>For screen size:</b>	32"-65"
<b>Type:</b>	Single Side MBW1U
<b>Universal &amp; VESA standard:</b>	100x100 200x200 300x300 400x400 mm
<b>Material:</b>	Steel, Aluminium
<b>Color:</b>	Black
<b>Weight:</b>	5.4 kg
<b>Measurements</b>	75,0x98x16cm
<b>Max Load:</b>	35 kg
<b>Height Adjustement:</b>	Yes, 10mm
<b>Tilt:</b>	Yes, -6~15°
<b>Swivel:</b>	Yes, 360°
<b>Rotate:</b>	Yes, ±4°
<b>Warranty:</b>	5 years

# SPECIFICATION \ DETAILS

Model name	Single AL rail 48cm(black)	Single AL rail 48cm (silver)	Single AL rail 68cm(black)	Single AL rail 68cm (silver)
				
<b>Article Nr / EAN</b>	7350073735082	7350073735099	7350073733866	7350073733705
<b>Length</b>	48 cm	48cm	68cm	68cm
<b>Colour</b>	Black	Silver	Black	Silver
<b>Material</b>	Aluminum	Aluminum	Aluminum	Aluminum
<b>Warranty</b>	5 years	5 years	5 years	5 years

Model name	Dual AL rail (black)	Dual AL rail (silver)	Triple AL rail (black)	Triple AL rail (silver)
				
<b>Article Nr / EAN</b>	7350073733873	7350073733712	7350073733880	7350073733729
<b>Length</b>	196 cm	196cm	348cm	348 cm
<b>Colour</b>	Black	Silver	Silver	Silver
<b>Material</b>	Aluminum	Aluminum	Aluminum	Aluminum
<b>Warranty</b>	5 years	5 years	5 years	5 years

















Model name	Extension pipe 80cm	Extension pipe 150cm	Extension pipe 300cm	Extension pipe (chrome)
				
<b>Article Nr / EAN</b>	7350073733804	7350073733811	7350073733828	7350073733835
<b>Length</b>	80 cm	150 cm	300 cm	300 cm
<b>Colour</b>	Black	Black	Black	Chrome
<b>Material</b>	Steel (SPCC Graded)	Steel (SPCC Graded)	Steel (SPCC Graded)	Steel (SPCC Graded)
<b>Warranty</b>	5 years	5 years	5 years	5 years

Model name		AL rail extension bars	Big wall plate	Small wall plate
				
<b>Article Nr / EAN</b>	7350073733842	7350073733682	7350073733675	7350073734184
<b>Length</b>	300 cm	20 cm	---	---
<b>Colour</b>	Brass	Chrome	Black	Black
<b>Material</b>	Steel (SPCC Graded)	Steel (SPCC Graded)	Steel (SPCC Graded)	Steel (SPCC Graded)
<b>Warranty</b>	5 years	5 years	5 years	5 years









# SPECIFICATION \ DETAILS

Model name	Tilt arms (20cm)	Tilt arms (40cm)	Tilt arms (60cm)	Tilt arms (90cm)
<b>Article Nr / EAN</b>	7350073733910	7350073733743	7350073733767	7350073733781
<b>VESA® &amp; non-VESA fixings</b>	VESA200 ,20cm	VESA400 ,40cm	VESA600 ,60cm	VESA900 ,90cm
<b>Max Load</b>	50kg (TUV30kg) Per screen	50kg (TUV30kg) Per screen	50kg (TUV30kg) Per screen	50kg (TUV30kg) Per screen
<b>Bracket Type</b>	Tilt	Tilt	Tilt	Tilt
<b>Colour</b>	Black	Black	Black	Black
<b>Material</b>	Steel (SPCC Graded)	Steel (SPCC Graded)	Steel (SPCC Graded)	Steel (SPCC Graded)
<b>Warranty</b>	5 years	5 years	5 years	5 years
Model name	Fixed arms (20cm)	Fixed arms (40cm)	Fixed arms (60cm)	Fixed arms (90cm)
<b>Article Nr / EAN</b>	7350073733903	7350073733736	7350073733750	7350073733774
<b>VESA® &amp; non-VESA fixings</b>	VESA200 ,20cm	VESA400 ,40cm	VESA600 ,60cm	VESA900 ,90cm
<b>Max Load</b>	50kg (TUV30kg) Per screen	50kg (TUV30kg) Per screen	50kg (TUV30kg) Per screen	50kg (TUV30kg) Per screen
<b>Bracket Type</b>	Fixed	Fixed	Fixed	Fixed
<b>Colour</b>	Black	Black	Black	Black
<b>Material</b>	Steel (SPCC Graded)	Steel (SPCC Graded)	Steel (SPCC Graded)	Steel (SPCC Graded)
<b>Warranty</b>	5 years	5 years	5 years	5 years
Model name	M Push in pop out pro VESA 400	M Monitor Fixed Pro75/100	M Monitor Flex Pro75/100	400mm Push HD Arms
<b>Article Nr / EAN</b>	7350073734726	7350073736300	7350073736294	7350073733798
<b>VESA® &amp; non-VESA fixings</b>	VESA400 ,40cm	VESA 75 / 100	VESA 75 / 100	VESA400 ,40cm
<b>Max Load</b>	40kg (TUV30kg) Per screen	15kg	15kg	50kg (TUV30kg) Per screen
<b>Bracket Type</b>	Push in Pop out arms	Fixed	Tilt	Micro-Adjustable Arms
<b>Colour</b>	Black	Black	Black	Black
<b>Material</b>	Steel (SPCC Graded)	Steel (SPCC Graded)	Steel (SPCC Graded)	Steel (SPCC Graded)
<b>Warranty</b>	5 years	5 years	5 years	5 years
Model name	Pole joiner	AL plastic cap	Pole clamp	Dual pole clamp
<b>Article Nr / EAN</b>	7350073734191	7350073733699	7350073733668	7350073735068
<b>Material</b>	Steel (SPCC Graded)	Plastic	Steel (SPCC Graded)	Steel (SPCC Graded)
<b>Colour</b>	Chrome	Black	Black	Black
<b>Warranty</b>	5 years	5 years	5 years	5 years

# SPECIFICATION \ DETAILS

Model name	VESA Flexarm Pro 400	Ceiling plate with plastic cover	Pro series ceiling plate HD	IPE 6.6 to 46.6 cm
				
<b>Article Nr / EAN</b>	7350073736331	7350073735075	7350073734696	7350073736386
<b>VESA® &amp; non-VESA fixings</b>	VESA400,40cm	---	---	---
<b>Max Load</b>	31.8kg	---	---	---
<b>Bracket Type</b>	Tilt	---	---	---
<b>Colour</b>	Black	Black	Black	Black
<b>Material</b>	Plastic + Steel (SPCC Graded)	Plastic + Steel (SPCC Graded)	Steel(SPCC Graded)	Steel(SPCC Graded)
<b>Warranty</b>	5 years	5 years	5 years	5 years
Model name	Pole clamp wall bracket	Truss clamp for 50mm pole	Pole drill fixture	Curved Screen Rail Joiner
				
<b>Article Nr / EAN</b>	7350073734177	7350073734320	7350073734214	7350073736348
<b>Colour</b>	Black	Black	Black	Black
<b>Material</b>	Aluminum+Steel(SPCC Graded)	Aluminum+Steel(SPCC Graded)	Steel (SPCC Graded)	Steel (SPCC Graded)
<b>Warranty</b>	5 years	5 years	5 years	5 years
Model name	Floor to ceiling wall plate(Black)	Floor to ceiling wall plate(White)	Floor to ceiling wall plate(Chrome)	Floor to ceiling wall plate(Brass)
				
<b>Article Nr / EAN</b>	7350073733651	7350073733859	7350073736188	7350073736195
<b>Colour</b>	Black	White	Chrome	Brass
<b>Material</b>	Plastic + Steel (SPCC Graded)	Plastic + Steel (SPCC Graded)	Plastic + Steel (SPCC Graded)	Plastic + Steel (SPCC Graded)
<b>Warranty</b>	5 years	5 years	5 years	5 years
Model name	Inner Ceiling Plate Cover(Black)	Inner Ceiling Plate Cover(White)	External Pipe cover(Black)	External Pipe cover(White)
				
<b>Article Nr / EAN</b>	7350073736270	7350073736287	7350073734221	7350073736201
<b>Colour</b>	Black	White	Black	White
<b>Material</b>	Plastic	Plastic	Plastic	Plastic
<b>Warranty</b>	5 years	5 years	5 years	5 years

# SPECIFICATION\DETAILS

Model name	External Pipe cover(Chrome)	External Pipe cover(Brass)	M Pro Series AV Shelf	M Pro Series Base Plate
				
Article Nr / EAN	7350073736218	7350073736225	7350073736430	7350073736447
Colour	Chrome	Brass	Black	Black
Material	Plastic	Plastic	Steel (SPCC Graded)	Steel (SPCC Graded)
Warranty	5 years	5 years	5 years	5 years
Model name	M push in pop out extender kit 600	Adjustable Feet Pro	Fixed Floorbase Pro	Camera Shelf
				
Article Nr / EAN	7350073734733	7350073736577	7350073736584	7350073736638
VESA® & non-VESA fixings	VESA600,60cm	---	---	---
Max Load	30kg	---	---	---
Bracket Type	Push in Pop out arms	---	---	---
Colour	Black	Black	Black	Black
Material	Steel (SPCC Graded)	Aluminum +Steel(SPCC Graded)	Steel(SPCC Graded)	Steel(SPCC Graded)
Warranty	5 years	5 years	5 years	5 years
Model name	Soundbar holder	Wheelbase 180cm Pro inc castors	Wheelbase 270cm Pro inc castors	Wheelbase 300cm Pro inc castors
				
Article Nr / EAN	7350073736645	7350073736591	7350073736607	7350073736614
Colour	Black	Black	Black	Black
Material	Steel(SPCC Graded)	Aluminum +Steel(SPCC Graded)	Aluminum +Steel(SPCC Graded)	Aluminum +Steel(SPCC Graded)
Warranty	5 years	5 years	5 years	5 years
Model name	Connecting Plate	Cable Management	Single display plate from wall	Back to back display plate from wall
				
Article Nr / EAN	7350073736973	7350073737482	7350073737338	7350073737345
Colour	Black	Black	Black	Black
Material	Steel(SPCC Graded)	Plastic	Steel(SPCC Graded)	Steel(SPCC Graded)
Warranty	5 years	5 years	5 years	5 years



# PRO SERIES

## MODEL NAME STRUCTURE

**M B 2 X 1 U P**

Multibrackets

2 rows

x1 units

Portrait position



# M PUBLIC BASIC FLOORSTAND 150

## IDEAL FOR HOME, EXHIBITIONS, MEETINGS AND CLASSROOMS.

The Multibrackets Floorstand Basic TV Trolley, is a mobile TV -Stand capable of supporting any LCD, LED, or Interactive -display up to a screen size 60", 50kg in weight and up to 600 x 400mm VESA.

**Q**uick and easy to install, combining neat design touches with robust quality, this superb value TV Trolley will give a lifetime of enjoyable and reliable performance. Perfect for use in education; classrooms, lecture theatres, or in commercial environments, Floorstand Basic features a large and stable base with four robust wheels. You can now move your valuable display safely and easily from room to room with smooth passage through doorways and over thresholds.

### HIGHLIGHTS:

Simple & Smart Design

For displays up to 60" or 50kg 's

VESA up to 600x400mm

Toolless height adjustment

AV Shelf & camera shelf included

Full hardware kit included



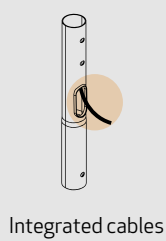

Integrated cables



Security lock

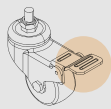

Locking casters

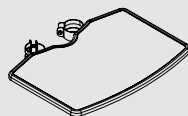

Storage shelf (included)

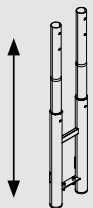

Height adjustment

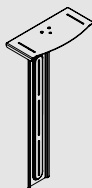

Camera shelf (included)

(These features are found in all Basic Floorstands)



**M Public Floorstand Basic 150**  
Shelf & Camera Holder included

<b>For screen size:</b>	32-60"
<b>Feature:</b>	Highly customizable
<b>Max VESA:</b>	600 x 400 mm
<b>VESA standard:</b>	100x100, 200x100, 200x200, 300x200, 300x300, 400x300, 400x400, 600x400 mm
<b>Article No:</b>	7350073732319
<b>Adjustable height:</b>	Yes
<b>Weight:</b>	16,5 kg
<b>Colour:</b>	Black
<b>Max load:</b>	50 kg
<b>DVD Shelf / Camera holder:</b>	Included
<b>Screen position:</b>	Landscape / Portrait
<b>Accessories:</b>	AV shelf and Camera holder included
<b>Lockable casters:</b>	Included (4 pcs)
<b>Warranty:</b>	5 years

# M PUBLIC BASIC FLOORSTAND 180

## PERFECT FOR EDUCATION OR COMMERCIAL ENVIRONMENTS

The Multibrackets Floorstand Basic TV Trolley 180, is a mobile TV-Stand capable of supporting most LCD, LED, or Interactive -displays up to a screen size 80", 90kg and holds VESA up to 800x500mm.

**F**its perfect for Video Conferencing, Classrooms, Trade exhibitions or other situations where viewers may be sitting or standing. You can choose the ideal height for the audience to whom you wish to deliver your presentation; whether sitting or standing and then make further fine height adjustments for even more optimal viewing. Our M Public Floorstand Basic 180 even allows easy adjustment of a screen for either Landscape or Portrait modes. In the case of our Basic 180 Trolley Stands, a camera shelf and av shelf are included, making these Mobile TV Stands the perfect all in one presentation solution.

### HIGHLIGHTS:

- Holds up to 80" and 90kg
- Robust design
- Tools free height adjustment
- AV shelf & Camera holder included
- Flat packed, Easy to assemble & disassemble





### M Public Floorstand Basic 180

Shelf & Camera Holder included

### M Public Floormount Basic 180

Shelf & Camera Holder included

### M Public Floorbase Basic 180

Shelf & Camera Holder included

<b>For screen size:</b>	55-80"	55-80"	55-80"
<b>Feature:</b>	Highly customizable	Highly customizable	Highly customizable
<b>Max VESA:</b>	800 x 500 mm	800 x 500 mm	800 x 500 mm
<b>VESA standard:</b>	200x200, 300x200, 300x300, 400x200, 400x400, 600x400, 800x400, 800x500mm	200x200, 300x200, 300x300, 400x200, 400x400, 600x400, 800x400, 800x500mm	200x200, 300x200, 300x300, 400x200, 400x400, 600x400, 800x400, 800x500mm
<b>Article No:</b>	7350073734627	7 350 073 737 246 Combination of Art: 4627+7222	7 350 073 737 239 Combination of Art: 4627+7215
<b>Size in mm: (WxDxH)</b>	850 x 600 x 2300 mm	850 x 600 x 2300 mm	850 x 600 x 2300 mm
<b>Adjustable height:</b>	Yes	Yes	Yes
<b>Weight:</b>	16,5 kg	16,5 kg	16,5 kg
<b>Colour:</b>	Black	Black	Black
<b>Max load:</b>	90 kg	90 kg	90 kg
<b>DVD Shelf / Camera holder:</b>	Included	Included	Included
<b>Package size:</b>	107,5 x 76,6 x 17,6 cm	107,5 x 76,6 x 17,6 cm	107,5 x 76,6 x 17,6 cm
<b>Screen position:</b>	Landscape (portrait possible but with limitations of bracket size/width)	Landscape (portrait possible but with limitations of bracket size/width)	Landscape (portrait possible but with limitations of bracket size/width)
<b>Accessories:</b>	AV shelf and Camera holder included	AV shelf and Camera holder included	AV shelf and Camera holder included
<b>Lockable casters:</b>	Included (4 pcs)	No	No
<b>Mount to floor:</b>	No	Yes (art no 7222 is included)	Yes (art no 7215 is included)
<b>Warranty:</b>	5 years	5 years	5 years

# M PUBLIC FLOORSTAND DUAL PILLAR 180 HD

## OUR MOST POWERFUL SOLUTION. DESIGNED TO INCLUDE ALL FEATURES YOU MAY NEED.

Introducing the M Public Floorstand Dual Pillar 180 HD with AV Cabinet a flat panel TV cart that was designed to include all of the features you may need, making it perfect for any application.

**T**he M Public Dual Pillar 180 HD is a unique designed product. Attractive and elegant it looks great placed in the center of the room or at the entrance of your office or reception. Suitable for large, heavy (up to 100kg) it can hold most displays in both landscape and portrait. The tool-less height adjustment is soft and quiet, readily available by the click of two buttons on each pillar. Cables and peripherals are completely hidden inside. With built in handles it is easy to move from room to room and allows you to work ergonomically.

### HIGHLIGHTS:

- Versatile design handling most applications
- Holds displays up to 100" or 90 kg 's
- VESA up to 1000x600
- A clean designed aluminum Heavy Duty construction
- Tool free height adjustment
- Intergrated cable management
- Optional AV cabinet, keeping your accessories in place
- Partially pre-assembled for quick assembly
- Full hardware kit included



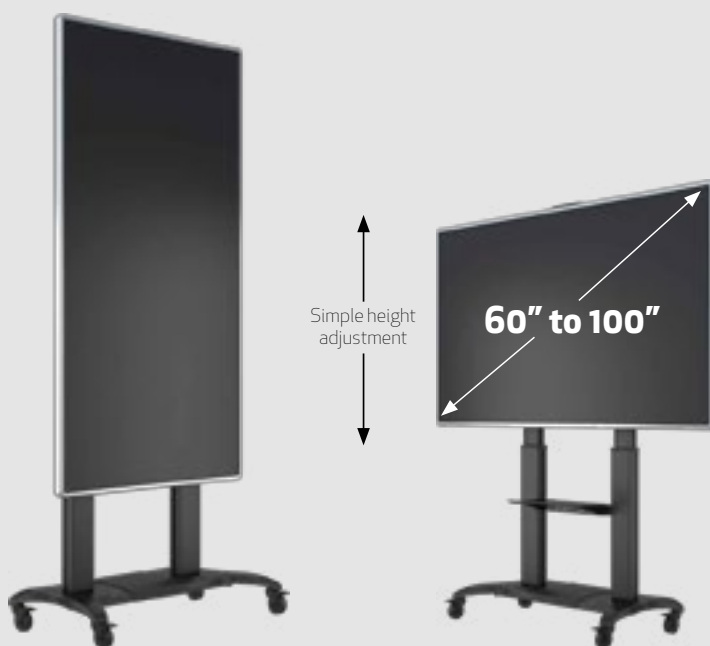

**M Public Floorstand  
Dual Pillar 180 HD**

**For screen size:** 60-100"

**Feature:** Large screen capacity

**Max VESA:** 1000 x 600 mm

**VESA standard:** 200x200 300x300 400x400  
600x400 600x600 700x500  
800x400 800x600 900x600  
up to 1000x600 mm

**Article No:** 7350073736324

**Size in mm: (WxDxH)** Package: 120x56x26 cm

**Adjustable height:** Yes, 1390-1740 mm

**Weight:** 45 kg

**Colour:** Black

**Max load:** 90 kg

**DVD Shelf / Camera holder:** Included

**Screen position:** Landscape / Portrait

**Lockable casters:** Included (4 pcs)

**Warranty:** 5 years

# M PUBLIC FLOORSTAND DUAL PILLAR 180 HD

## with AV Cabinet

Our M Public Dual Pillar 180 HD with AV Cabinet is a powerful and well-designed product suitable for multiple environments including education, corporate and digital signage.

With its lockable storage rack (the storage cabinet comes fully pre-assembled) it can store your AV components or videoconference tools. With its spacious cabinet it is perfect for video conferencing or any other corporate situation. Its massive capacity of up to 100" displays or 90kg weight capacity it is most suitable for larger displays. With its lockable castors makes the floorstand stay still where you want it. An intelligent and tool-less designed height adjustment built into the columns makes height adjustment possible. Cables & peripherals are neatly hidden within the backside of the columns making the installation look clean and easy to move around when needed.

### HIGHLIGHTS:

- Heavy Duty Design with 90kg weight capacity
- Lockable AV Storage
- Ready for videoconference
- Camera shelf included
- Holds VESA up to 1000x600
- Toolless height adjustment
- Cable management built in
- Partially pre-assembled for quick assembly
- Full hardware kit included



**M Public Floorstand  
Dual Pillar 180 HD  
with AV Cabinet**

<b>For screen size:</b>	60-100"
<b>Feature:</b>	Large screen capacity
<b>Max VESA:</b>	1000 x 600 mm
<b>VESA standard:</b>	200x200 300x300 400x400 600x400 600x600 700x500 800x400 800x600 900x600 up to 1000x600 mm
<b>Article No:</b>	7 350 073 737 680 Combination of Art: 6324+7673
<b>Size in mm: (WxDxH)</b>	Package: 120x56x26 cm
<b>Adjustable height:</b>	Yes, 1390-1740 mm
<b>Weight:</b>	45 kg
<b>Colour:</b>	Black
<b>Max load:</b>	90 kg
<b>DVD Shelf / Camera holder:</b>	Included
<b>Screen position:</b>	Landscape (Portrait possible w/o cabinet)
<b>Lockable casters:</b>	Included (4 pcs)
<b>Warranty:</b>	5 years





**CAMERA HOLDER** (Included)

**SECURITY LOCK**

**VARIABLE VESA STANDARD**  
Easy adjust VESA  
up to 1000x600

**VARIABLE HEIGHT**  
Easy adjust displays  
height for a perfect view

**AV CABINET WITH LOCK** (Included)

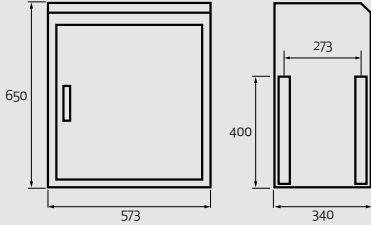

**NESTABLE**  
An open base design lets  
you nest floorstands  
and minimize your  
storage requirements

**ALL ALUMINUM BASE**

**LOCKING CASTERS**  
4 locking casters  
makes it easy to  
make this floorstand  
stay in place

## PUBLIC BASIC FLOORSTANDS 150

### M Public Floorstand Shelf Basic 150

<b>For:</b>	Static environments
<b>Feature:</b>	Perfect for conference rooms
<b>Material:</b>	Steel
<b>Article No:</b>	735007373215
<b>Adjustable height / Length:</b>	Yes, within the pillar / Yes
<b>Weight:</b>	1 kg
<b>Colour:</b>	Black
<b>Max load:</b>	10 kg
<b>Warranty:</b>	5 years



## M PUBLIC FLOORSTAND DUAL PILLAR 180

### M Public Floorstand Shelf Dual Pillar 180 HD

<b>For:</b>	PC, DVD or any other electronics
<b>Feature:</b>	Adjustable height
<b>Material:</b>	Steel
<b>Article No:</b>	735007373406
<b>Size in mm: (WxD)</b>	273x455 mm
<b>Adjustable height / Length:</b>	Yes, within the pillar / Yes
<b>Weight:</b>	0,5 kg
<b>Colour:</b>	Black
<b>Max load:</b>	10 kg
<b>Warranty:</b>	5 years



### AV Cabinet M Public Floorstand Dual Pillar 180 HD

<b>Suitable for:</b>	M Public Display Stand Series
<b>Feature:</b>	Safe storage for electronic equipment
<b>Article No:</b>	7350073737673
<b>Adjustable height / Door lock:</b>	Yes / Yes
<b>Measurements: (D/W/H)</b>	391x530x204mm
<b>Gross weight:</b>	13kg
<b>Net weight:</b>	12kg
<b>Colour:</b>	Black
<b>Cable management:</b>	Yes
<b>Warranty:</b>	5 years



## PUBLIC BASIC FLOORSTANDS 180

### M Public Floorstand Shelf Basic 180

<b>For:</b>	PC, DVD or any other electronics
<b>Feature:</b>	Adjustable height
<b>Material:</b>	Steel
<b>Article No:</b>	7350073737390
<b>Size in mm: (WxD)</b>	273x455 mm
<b>Adjustable height / Length:</b>	Yes, within the pillar / Yes
<b>Weight:</b>	0,5 kg
<b>Colour:</b>	Black
<b>Max load:</b>	10 kg
<b>Warranty:</b>	5 years



### M Public Floorstand Basic 180 Floorbase

<b>For:</b>	Static environments
<b>Feature:</b>	Perfect for conference rooms
<b>Material:</b>	Steel
<b>Article No:</b>	7350073737215
<b>Size in mm: (WxDxH)</b>	807x645x100mm
<b>Mount directly to floor:</b>	Yes
<b>Weight:</b>	21 kg
<b>Colour:</b>	Black
<b>Warranty:</b>	5 years



### M Public Floorstand Basic 180 Floormount

<b>For:</b>	Static environments
<b>Feature:</b>	Perfect for conference rooms
<b>Material:</b>	Steel
<b>Article No:</b>	7350073737222
<b>Size in mm: (WxDxH)</b>	389x180x95mm
<b>Mount directly to floor:</b>	Yes
<b>Weight:</b>	4 kg
<b>Colour:</b>	Black
<b>Warranty:</b>	5 years



# Officeline Pro

## Total flexibility - Build your desktop monitorwall after your needs

### HIGHLIGHTS:

- A high level designed productline for office use.
- Made for the semi professional user.
- Creates maximum ergonomic comfort for displays.
- Simplified installation and simple after adjustment possibilities.
- Plexi based cable management.

Officeline Pro 's key advantage is its modularity. This line up meets the needs of virtually every requirement in the modern computer workstation environment, offering exceptional adjustment; display, tilt, swivel and rotation and can accommodate a wide range of monitor weights and sizes.

Create the ideal multi display arrangement and position your monitors individually to increase productivity, reduce eye, neck and shoulder strain. At the same time, you will be saving space and creating the ultimate viewing position for each monitor with micro adjustment possibilities for each display. The products are slender and low profile yet the weighted base provides enhanced stability and minimize clutter with the intuitive cable management system.

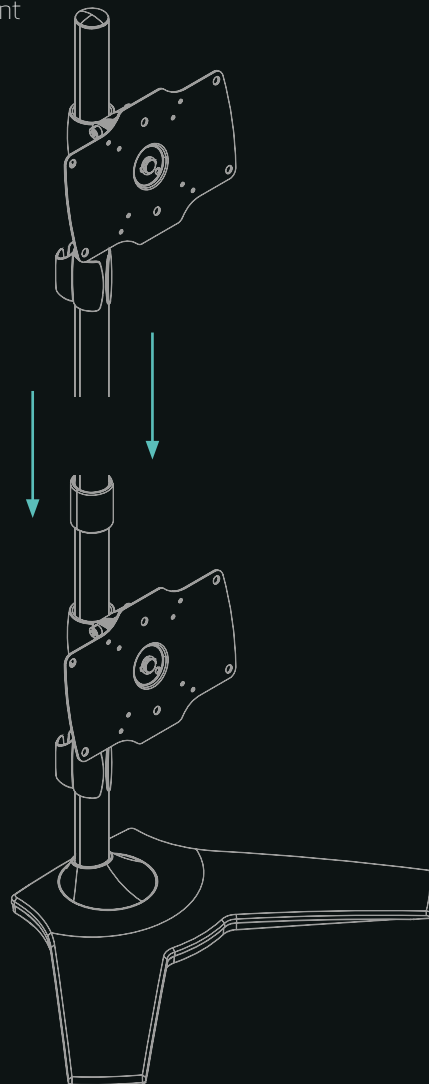

Portrait / Landscape



Vesa Standard



Height Adjustment



Cable Management



Tilt Adjustment



Extensibility

Perfect for designers,  
architects and other  
professional users





M VESA Desktopmount [Single Stand 24"-32"](#)



M VESA Desktopmount [Dual Stand 24"-32"](#)



M VESA Desktopmount [Triple Stand 15"-24"](#)



M VESA Desktopmount [Triple Stand 24"-32"](#)

**Officeline Pro - Specification**

Model:	M VESA Desktopmount <a href="#">Single Stand 24"-32"</a>	M VESA Desktopmount <a href="#">Dual Stand 24"-32"</a>	M VESA Desktopmount <a href="#">Triple Stand 15"-24"</a>	M VESA Desktopmount <a href="#">Triple Stand 24"-32"</a>
<b>For screen size:</b>	24"-32"	24"-32"	15"-24" (Max screen width: 575 mm)	24"-32"
<b>VESA standard:</b>	75x75, 100x100, 200x100	75x75, 100x100, 200x100	75x75 100x100	75x75 / 100x100 / 200x100 mm
<b>Article No:</b>	7 350 022 737 396	7 350 022 737 419	7 350 022 734 999	7 350 073 731 312
<b>Size in mm:</b>	Available shortly	Available shortly	1280x370x307(W*H*D)	1696x504x135 (W*H*D)
<b>Weight:</b>	3,5 kg	4,5 kg	5,3 kg	7 kg
<b>Colour:</b>	Black	Black	Black	Black
<b>Max load:</b>	15 kg for each screen	15 kg for each screen	8 kg for each screen	8 kg for each screen
<b>Material:</b>	Steel/ Aluminium Alloy/ Plastic	Steel/ Aluminium Alloy/ Plastic	Steel/ Aluminium Alloy/ Plastic	Steel/ Aluminium Alloy/ Plastic
<b>Tilt:</b>	Up to +/-20 degrees for each screen	Up to +/-20 degrees for each screen	Up to +/-20 degrees for each screen	+15° ~ -10°
<b>Rotate:</b>	Up to +/-90 degrees for each screen	Up to +/-90 degrees for each screen	Up to +/-90 degrees for each screen	Up to +/-360° for each screen
<b>Yaw:</b>	Not available	+/-10 degrees	+/-10 degrees	-
<b>Warranty:</b>	5 years	5 years	5 years	5 years



M VESA Desktopmount [Single Stand 24"-32"](#) Expansion Kit

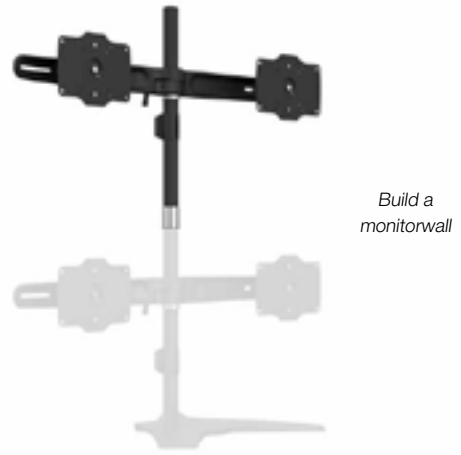

M VESA Desktopmount [Dual Stand 24"-32"](#) Expansion Kit

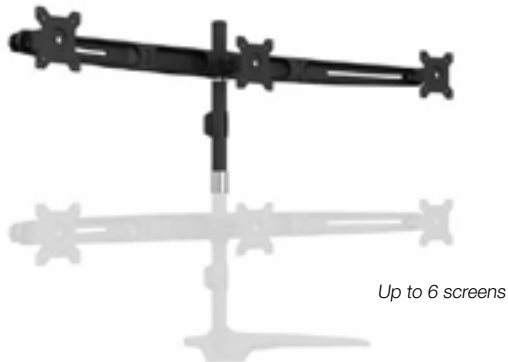

M VESA Desktopmount [Triple Stand 15"-24"](#) Expansion Kit

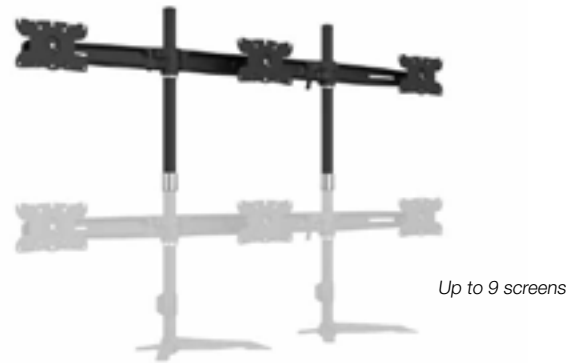

M VESA Desktopmount [Triple Stand 24"-32"](#) Expansion Kit

**Officeline Pro Expansion Kits - Specification**

Model:	M VESA Desktopmount <a href="#">Single Stand 24"-32"</a> Expansion Kit	M VESA Desktopmount <a href="#">Dual Stand 24"-32"</a> Expansion Kit	M VESA Desktopmount <a href="#">Triple Stand 15"-24"</a> Expansion Kit	M VESA Desktopmount <a href="#">Triple Stand 24"-32"</a> Expansion Kit
<b>For screen size:</b>	24"-32" (Max screen width: 575 mm)	24"-32" (Max screen width: 840 mm)	15"-24" (Max screen width: 575 mm)	24"-32"
<b>VESA standard:</b>	75x75, 100x100, 200x100	75x75, 100x100, 200x100	75x75 100x100	75x75 / 100x100 / 200x100mm
<b>Article No:</b>	7 350 022 737 402	7 350 022 737 426	7 350 022 735 002	7 350 073 731 329
<b>Size in mm:</b>	Available shortly	Available shortly	1280x388x77(W*H*D)	1696x946x135(W*H*D)
<b>Weight:</b>	2,5 kg	3,5 kg	4,5 kg	6,26 kg
<b>Colour:</b>	Black	Black	Black	Black
<b>Max load:</b>	12 kg for each screen	12 kg for each screen	8 kg for each screen	8 kg for each screen
<b>Tilt:</b>	Up to +/-20 degrees for each screen	Up to +/-20 degrees for each screen	Up to +/-20 degrees for each screen	Up to +15 / -10 degrees for each screen
<b>Rotate:</b>	Up to +/-90 degrees for each screen	Up to +/-90 degrees for each screen	Up to +/-90 degrees for each screen	Up to +/-360 degrees for each screen
<b>Yaw:</b>	Not available	+/-10 degrees	+/-10 degrees	-
<b>Warranty:</b>	5 years	5 years	5 years	5 years

# **Accessories**

*Officeline Pro*



<b>Model:</b>	<b>M Desktopmount</b> <b>VESA Adapter 200x200</b>
<b>Article No:</b>	7 350 073 731 909
<b>Suitable for:</b>	M VESA Desktopmount Officeline Pro
<b>Colour:</b>	Black
<b>Weight:</b>	0.26 kg
<b>Warranty:</b>	5 years



<b>Model:</b>	<b>M Desktopmount</b> <b>Single-Dual-Triple Stand</b> <b>Grommet Base</b>
<b>Article No:</b>	7 350 022 737 433
<b>Suitable for:</b>	M VESA Desktopmount Officeline Pro
<b>Colour:</b>	Black
<b>Weight:</b>	0.5 kg
<b>Warranty:</b>	5 years



<b>Model:</b>	<b>M Desktopmount</b> <b>Single-Dual-Triple Stand</b> <b>Desk Clamp</b>
<b>Article No:</b>	7 350 022 735 019
<b>Suitable for:</b>	M VESA Desktopmount Officeline Pro
<b>Colour:</b>	Black
<b>Weight:</b>	2 kg
<b>Warranty:</b>	5 years



<b>Model:</b>	<b>M Desktopmount</b> <b>Single / Dual / Triple</b> <b>Stand 46cm Pipe</b>
<b>Article No:</b>	7 350 022 737 440
<b>Suitable for:</b>	M VESA Desktopmount Officeline Pro
<b>Colour:</b>	Black
<b>Weight:</b>	1.5 kg
<b>Warranty:</b>	5 years



# Officeline

**Frees up space** - Allowing positioning of your display for greater productivity

## HIGHLIGHTS:

- A high level designed productline for office use.
- Made for the semi professional user.
- Creates maximum ergonomic comfort for displays.
- Simplified installation and simple after adjustment possibilities.
- Plexi based cable management.
- Optional through hole installation with Grommet Base.

From a simple single monitor desk stand to a more system like thinking capable of handling multiple monitors. Multibrackets Officeline offers a wide variety of stands to meet virtually any demand. Low-profile, single monitor stands allowing the user to freely position the monitor anywhere along the edge of the desk allowing a line of sight across the table.

At the other end of the spectrum, the multi monitor Officeline Dual and Quad mounting system offering great scalability: Start with two monitors and gradually expand to 3, 4, 6, or 8 monitors as your needs change, while independently adjusting each monitor to the precise position and angle you need.

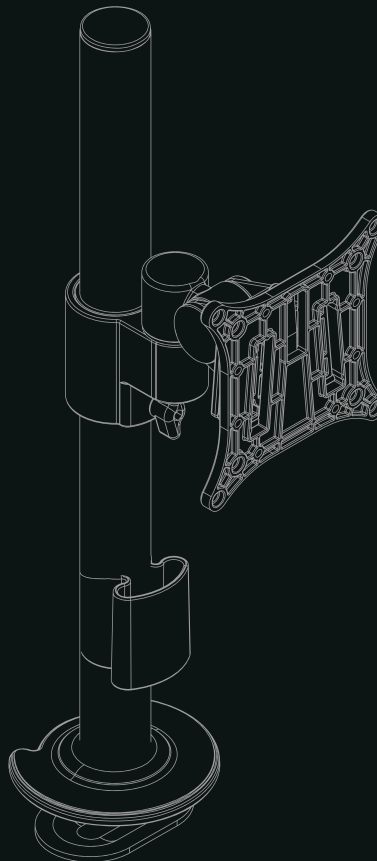

Portrait / Landscape



Vesa Standard



Height Adjustment



Back To Back



Cable Management



Tilt Adjustment

Aimed for office users  
searching for flexible design  
and attention to details





M VESA Desktop Mount Officeline [Single](#)



M VESA Desktop Mount Officeline [Single I](#)



M VESA Desktop Mount Officeline [Single II](#)



M VESA Desktop Mount Officeline [Dual](#)

**Officeline - Specification**

Model:	M VESA Desktop Mount Officeline <a href="#">Single</a>	M VESA Desktop Mount Officeline <a href="#">Single I</a>	M VESA Desktop Mount Officeline <a href="#">Single II</a>	M VESA Desktop Mount Officeline <a href="#">Dual</a>
<b>Article No:</b>	7 350 073 735 822	7 350 073 735 839	7 350 073 735 846	7 350 073 735 853
<b>Colour:</b>	Black	Black	Black	Black
<b>For screen size:</b>	15-30"	15-30"	15-30"	15-30"
<b>Universal &amp; VESA standard:</b>	75x75 100x100 mm	75x75 100x100 mm	75x75 100x100 mm	75x75 100x100 mm
<b>Material:</b>	Steel	Steel	Steel	Steel
<b>Max load:</b>	8 kg	8 kg	8 kg	8 kg per screen
<b>Weight:</b>	2.2 kg	2.5 kg	2.9 kg	2.5 kg
<b>Measurements:</b>	116x32x480 (D*W*H)	311x32x480 (D*W*H)	506x32x480 (D*W*H)	116x32x480 (D*W*H)
<b>Adjustable height from table top to VESA plate center:</b>	0 - 480mm	0 - 480mm	0 - 480mm	0 - 480mm
<b>Tilt:</b>	Yes 85° -60°	Yes 85° -60°	Yes 85° -60°	Yes 85° -60°
<b>Swivel:</b>	Yes 360°	Yes 360°	Yes 360°	Yes 360°
<b>Pivot:</b>	Yes ±90°	Yes ±90°	Yes ±90°	Yes ±90°
<b>Installation:</b>	Desk clamp, adjustable 10 - 50mm	Desk clamp, adjustable 10 - 50mm	Desk clamp, adjustable 10 - 50mm	Desk clamp, adjustable 10 - 50mm
<b>Option:</b>	M VESA Desktop Mount Officeline Grommet Base Black - Art: 5884	M VESA Desktop Mount Officeline Grommet Base Black - Art: 5884	M VESA Desktop Mount Officeline Grommet Base Black - Art: 5884	M VESA Desktop Mount Officeline Grommet Base Black - Art: 5884
<b>For desktop width:</b>	10 - 50mm	10 - 50mm	10 - 50mm	10 - 50mm
<b>Warranty:</b>	5 years	5 years	5 years	5 years



M VESA Deskmount Officeline [Dual B2B](#)



M VESA Deskmount Officeline [Dual Vertical](#)



M VESA Deskmount Officeline [Quad B2B](#)



M VESA Deskmount Officeline [Quad](#)

**Officeline - Specification**

Model:	M VESA Deskmount Officeline <a href="#">Dual B2B</a>	M VESA Deskmount Officeline <a href="#">Dual Vertical</a>	M VESA Deskmount Officeline <a href="#">Quad B2B</a>	M VESA Deskmount Officeline <a href="#">Quad</a>
<b>Article No:</b>	7 350 073 735 860	7 350 073 735 877	7 350 073 735 907	7 350 073 735 891
<b>Colour:</b>	Black	Black	Black	Black
<b>For screen size:</b>	15-30"	15-30"	15-30"	15-30"
<b>Universal &amp; VESA standard:</b>	75x75 100x100 mm	75x75 100x100 mm	75x75 100x100 mm	75x75 100x100 mm
<b>Material:</b>	Steel	Steel	Steel	Steel
<b>Max load:</b>	8 kg per screen	8 kg per screen	8 kg per screen	8 kg per screen
<b>Weight:</b>	4.1 kg	2.4 kg	4.1 kg	4.1 kg
<b>Measurements:</b>	506x32x480 (D*W*H)	116x32x910 (D*W*H)	506x32x900 (D*W*H)	506x32x900 (D*W*H)
<b>Adjustable height from table top to VESA plate center:</b>	0 - 480mm	0 - 910mm	0 - 900mm	0 - 900mm
<b>Tilt:</b>	Yes 85- -60°	Yes 85- -60°	Yes 85- -60°	Yes 85- -60°
<b>Swivel:</b>	Yes 360°	Yes 360°	Yes 360°	Yes 360°
<b>Pivot:</b>	Yes ±90°	Yes ±90°	Yes ±90°	Yes ±90°
<b>Installation:</b>	Desk clamp, adjustable 10 - 50mm	Desk clamp, adjustable 10 - 50mm	Desk clamp, adjustable 10 - 50mm	Desk clamp, adjustable 10 - 50mm
<b>Option:</b>	M VESA Deskmount Officeline Grommet Base Black - Art: 5884	M VESA Deskmount Officeline Grommet Base Black - Art: 5884	M VESA Deskmount Officeline Grommet Base Black - Art: 5884	M VESA Deskmount Officeline Grommet Base Black - Art: 5884
<b>For desktop width:</b>	10 - 50mm	10 - 50mm	10 - 50mm	10 - 50mm
<b>Warranty:</b>	5 years	5 years	5 years	5 years



M VESA Deskmount Officeline [Single](#)



M VESA Deskmount Officeline [Single I](#)



M VESA Deskmount Officeline [Single II](#)



M VESA Deskmount Officeline [Dual](#)

**Officeline - Specification**

Model:	M VESA Deskmount Officeline <a href="#">Single</a>	M VESA Deskmount Officeline <a href="#">Single I</a>	M VESA Deskmount Officeline <a href="#">Single II</a>	M VESA Deskmount Officeline <a href="#">Dual</a>
<b>Article No:</b>	7 350 073 735 150	7 350 073 735 167	7 350 073 735 174	7 350 073 735 181
<b>Colour:</b>	White	White	White	White
<b>For screen size:</b>	15-30"	15-30"	15-30"	15-30"
<b>Universal &amp; VESA standard:</b>	75x75 100x100 mm	75x75 100x100 mm	75x75 100x100 mm	75x75 100x100 mm
<b>Material:</b>	Steel	Steel	Steel	Steel
<b>Max load:</b>	8 kg	8 kg	8 kg	8 kg per screen
<b>Weight:</b>	2.2 kg	2.5 kg	2.9 kg	2.5 kg
<b>Measurements:</b>	116x32x480 (D*W*H)	311x32x480 (D*W*H)	506x32x480 (D*W*H)	116x32x480 (D*W*H)
<b>Adjustable height from table top to VESA plate center:</b>	0 - 480mm	0 - 480mm	0 - 480mm	0 - 480mm
<b>Tilt:</b>	Yes 85- -60°	Yes 85- -60°	Yes 85- -60°	Yes 85- -60°
<b>Swivel:</b>	Yes 360°	Yes 360°	Yes 360°	Yes 360°
<b>Pivot:</b>	Yes ±90°	Yes ±90°	Yes ±90°	Yes ±90°
<b>Installation:</b>	Desk clamp, adjustable 10 - 50mm	Desk clamp, adjustable 10 - 50mm	Desk clamp, adjustable 10 - 50mm	Desk clamp, adjustable 10 - 50mm
<b>Option:</b>	M VESA Deskmount Officeline Grommet Base White - Art: 5303	M VESA Deskmount Officeline Grommet Base White - Art: 5303	M VESA Deskmount Officeline Grommet Base White - Art: 5303	M VESA Deskmount Officeline Grommet Base White - Art: 5303
<b>For desktop width:</b>	10 - 50mm	10 - 50mm	10 - 50mm	10 - 50mm
<b>Warranty:</b>	5 years	5 years	5 years	5 years



M VESA Deskmount Officeline [Dual B2B](#)



M VESA Deskmount Officeline [Dual Vertical](#)



M VESA Deskmount Officeline [Quad B2B](#)



M VESA Deskmount Officeline [Quad](#)

**Officeline** - Specification

Model:	M VESA Deskmount Officeline <a href="#">Dual B2B</a>	M VESA Deskmount Officeline <a href="#">Dual Vertical</a>	M VESA Deskmount Officeline <a href="#">Quad B2B</a>	M VESA Deskmount Officeline <a href="#">Quad</a>
<b>Article No:</b>	7 350 073 735 198	7 350 073 735 297	7 350 073 735 594	7 350 073 735 587
<b>Colour:</b>	White	White	White	White
<b>For screen size:</b>	15-30"	15-30"	15-30"	15-30"
<b>Universal &amp; VESA standard:</b>	75x75 100x100 mm	75x75 100x100 mm	75x75 100x100 mm	75x75 100x100 mm
<b>Material:</b>	Steel	Steel	Steel	Steel
<b>Max load:</b>	8 kg per screen	8 kg per screen	8 kg per screen	8 kg per screen
<b>Weight:</b>	4.1 kg	2.4 kg	4.1 kg	4.1 kg
<b>Measurements:</b>	506x32x480 (D*W*H)	116x32x910 (D*W*H)	506x32x900 (D*W*H)	506x32x900 (D*W*H)
<b>Adjustable height from table top to VESA plate center:</b>	0 - 480mm	0 - 910mm	0 - 900mm	0 - 900mm
<b>Tilt:</b>	Yes 85- -60°	Yes 85- -60°	Yes 85- -60°	Yes 85- -60°
<b>Swivel:</b>	Yes 360°	Yes 360°	Yes 360°	Yes 360°
<b>Pivot:</b>	Yes ±90°	Yes ±90°	Yes ±90°	Yes ±90°
<b>Installation:</b>	Desk clamp, adjustable 10 - 50mm	Desk clamp, adjustable 10 - 50mm	Desk clamp, adjustable 10 - 50mm	Desk clamp, adjustable 10 - 50mm
<b>Option:</b>	M VESA Deskmount Officeline Grommet Base White - Art: 5303	M VESA Deskmount Officeline Grommet Base White - Art: 5303	M VESA Deskmount Officeline Grommet Base White - Art: 5303	M VESA Deskmount Officeline Grommet Base White - Art: 5303
<b>For desktop width:</b>	10 - 50mm	10 - 50mm	10 - 50mm	10 - 50mm
<b>Warranty:</b>	5 years	5 years	5 years	5 years

# **Accessories**

*Officeline*



**Model:** M VESA Deskmount Officeline  
75 100 Quick Release Plate

**Article No:** 7 350 073 735 389

**Suitable for:** M VESA Deskmount Officeline Series

**Colour:** Black

**Weight:** 0.1 kg

**Warranty:** 2 years



**Model:** M VESA Deskmount Officeline  
50 Quick Release Plate

**Article No:** 7 350 073 735 372

**Suitable for:** M VESA Deskmount Officeline Series

**Colour:** Black

**Weight:** 0.1 kg

**Warranty:** 2 years



**Model:** M VESA Deskmount Officeline  
Grommet Base Black

**Article No:** 7 350 073 735 884

**Suitable for:** M VESA Deskmount Officeline Series

**For screen size:** 15" - 32"

**Colour:** Black

**Warranty:** 5 years



**Model:** M VESA Deskmount Officeline  
Grommet Base White

**Article No:** 7 350 073 735 303

**Suitable for:** M VESA Deskmount Officeline Series

**For screen size:** 15" - 32"

**Colour:** Black

**Warranty:** 5 years



# Deskline

Increase your productivity & free up desk space  
Optimize your office or gaming setup

## HIGHLIGHTS:

- Gracefully adjust your monitors height and position.
- Rotate monitor to landscape or portrait mode.
- High grade materials with anti scratch surfaces.
- Built in cable management system.

This series of free standing or clamp based mount lets you install one, two, three or four displays up to 27", on a single base that you can place in virtually any workspace. The black finish complements your office decor. Set up a single or multi monitor workstation with this VESA monitor stand (75x75, 100x100 mm) to multitask faster and boost your productivity.

Compare and edit files on two screens with ease. Rotate your monitors 360 degrees for portrait or landscape viewing. Free up desk space with the low profile base and maximize the surface area. Its crossbar design keeps your monitors perfectly aligned and makes it easy to mount and finetune adjust two flat panel displays side by side. The monitor stand features a flat, low profile back so you can position your displays against an office wall or cubicle wall to free up space.

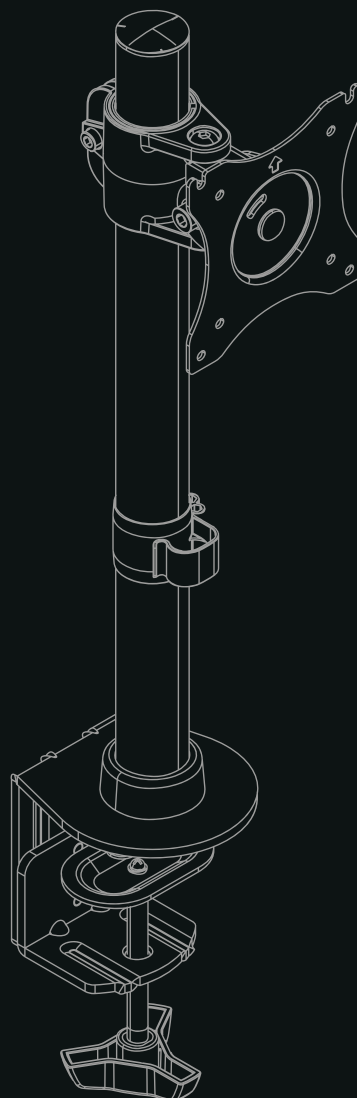

Portrait / Landscape



Vesa Standard



Height Adjustment



Cable Management



Tilt adjustment

Ramp up your ergonomic comfort at a great pricepoint





M Deskmount [Basic Single](#)



M Deskstand [Basic Single](#)



M Deskmount [Basic Dual](#)



M Deskstand [Basic Dual](#)

Deskline - Specification

Model:	M Deskmount <a href="#">Basic Single</a>	M Deskstand <a href="#">Basic Single</a>	M Deskmount <a href="#">Basic Dual</a>	M Deskstand <a href="#">Basic Dual</a>
<b>Article No:</b>	7 350 073 733 293	7 350 073 733 323	7 350 073 733 309	7 350 073 733 330
<b>Colour:</b>	Black	Black	Black	Black
<b>For screen size:</b>	15-27"	15-27"	15-27"	15-27"
<b>Universal &amp; VESA standard:</b>	75x75 100x100 mm	75x75 100x100 mm	75x75 100x100 mm	75x75 100x100 mm
<b>Material:</b>	Aluminum, Steel	Aluminum, Steel	Aluminum, Steel	Aluminum, Steel
<b>Weight:</b>	2.58 kg	3.58 kg	4.04kg	5.04 kg
<b>Measurements:</b>	11.6x12x55 cm	11.6x12x55 cm	11.6x12x55 cm	11.6x12x55 cm
<b>Max load:</b>	10 kg	10 kg	8 kg per screen	10 kg
<b>Adjustable height from table top to VESA plate center:</b>	100 - 450 mm	100 - 450 mm	100 - 400mm	100 - 450 mm
<b>Tilt:</b>	Yes ±45°	Yes ±45°	Yes ±45°	Yes ±45°
<b>Swivel:</b>	Yes ±45°	Yes ±45°	Yes ±45°	Yes ±45°
<b>Rotate:</b>	Yes 360°	Yes 360°	Yes 360°	Yes 360°
<b>Installation:</b>	Desk clamp, adjustable 10 - 85mm	Deskstand	Desk clamp, adjustable 10 - 85mm	Deskstand
<b>Option:</b>	*Article: 7350073733408, M Deskmount Grommet Base*	*Article: 7350073733408, M Deskmount Grommet Base*	*Article: 7350073733408, M Deskmount Grommet Base*	*Article: 7350073733408, M Deskmount Grommet Base*
<b>Warranty:</b>	5 years	5 years	5 years	5 years



M Deskmount [Basic Triple](#)



M Deskstand [Basic Triple](#)



M Deskmount [Basic Quad](#)



M Deskstand [Basic Quad](#)

Deskline - Specification

Model:	M Deskmount <a href="#">Basic Triple</a>	M Deskstand <a href="#">Basic Triple</a>	M Deskmount <a href="#">Basic Quad</a>	M Deskstand <a href="#">Basic Quad</a>
<b>Article No:</b>	7 350 073 733 385	7 350 073 733 392	7 350 073 733 316	7 350 073 733 347
<b>Colour:</b>	Black	Black	Black	Black
<b>For screen size:</b>	15-27"	15-27"	15-27"	15-27"
<b>Universal &amp; VESA standard:</b>	75x75 100x100 mm	75x75 100x100 mm	75x75 100x100 mm	75x75 100x100 mm
<b>Material:</b>	Aluminum, Steel	Aluminum, Steel	Aluminum, Steel	Aluminum, Steel
<b>Max load:</b>	8 kg per screen	8 kg per screen	8 kg per screen	8 kg per screen
<b>Weight:</b>	6.3 kg	7.8 kg	7.3kg	8.3 kg
<b>Measurements:</b>	144.8 x 12 x 55 cm	144.8 x 31.6 x 46.6 cm	144.8 x 31.6 x 46.6 cm	144.8 x 31.6 x 46.6 cm
<b>Adjustable height from table top to VESA plate center:</b>	100 - 450mm	100 - 450 mm	100 - 750mm	100 - 450 mm
<b>Tilt:</b>	Yes ±45°	Yes ±45°	Yes ±45°	Yes ±45°
<b>Swivel:</b>	Yes ±45°	Yes ±45°	Yes ±45°	Yes ±45°
<b>Rotate:</b>	Yes 360°	Yes 360°	Yes 360°	Yes 360°
<b>Installation:</b>	Desk clamp, adjustable 10 - 85mm	Deskstand	Desk clamp, adjustable 10 - 85mm	Deskstand
<b>Option:</b>	*Article: 7350073733408, M Deskmount Grommet Base*	*Article: 7350073733408, M Deskmount Grommet Base*	*Article: 7350073733408, M Deskmount Grommet Base*	*Article: 7350073733408, M Deskmount Grommet Base*
<b>Warranty:</b>	5 years	5 years	5 years	5 years

# **Accessories**

*Deskline*

**Model:** M VESA Monitor Slider Black

**Article No:** 7 350 073 737 796

**Suitable for:** Deskline

**For screen size:** 13" - 27"

**Colour:** Black

**Weight:** 0.74 kg

**Warranty:** 5 years



**Model:** M Basic Tablestand for Single/Dual/Triple/Quad Basic Arms

**Article No:** 7 350 073 735 457

**Suitable for:** Deskline

**Colour:** Black

**Weight:** 2 kg

**Warranty:** 5 years



**Model:** M Basic Clamp for Single/Dual/Triple/Quad M Basic Arm

**Article No:** 7 350 073 735 440

**Suitable for:** Deskline

**Colour:** Black

**Weight:** 2 kg

**Warranty:** 5 years



**Model:** M Deskmount Basic Single/Dual/Triple/Quad Grommet Base

**Article No:** 7 350 073 733 408

**Suitable for:** Deskline

**Colour:** Black

**Weight:** 1.5 kg

**Warranty:** 5 years



# Improve your posture

Office Ergonomics - How to battle a poor posture. With the continuing rise in popularity of computers and mobile devices, an increase in postural strain is being placed on our bodies. Poor posture while using desktops, notebooks and multiple screens on the desk place the

upper body in a position of increased neck flexion with rounded shoulder posturing. This can lead to a variety of musculoskeletal issues and postural deviations. Given the length of time spent in these postures on a daily basis, places office workers at an even higher risk of developing disorders.

For these reasons, it is important to ensure proper office ergonomics are in place. Maybe it's time for your business to discover a new level of refinement with our Monitor Stands and Gas lift solutions.



## 5 tips for an ideal sitting position

- Shoulders relaxed
- Straight back
- Circulation in legs
- Healthy hip and knee joints
- Feet flat on the floor

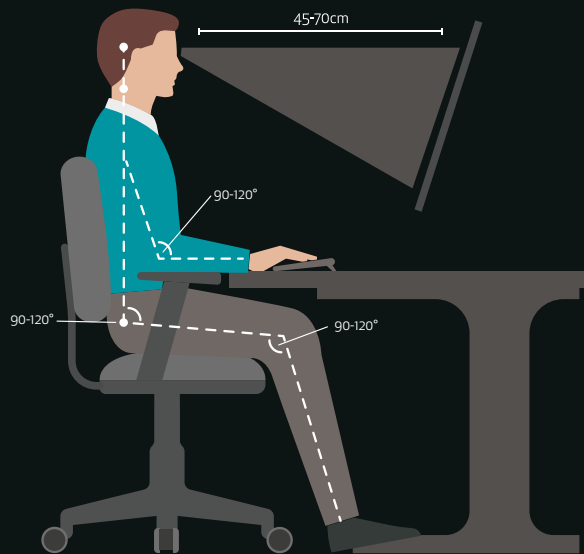

### MONITOR

Adjust distance and height top of the monitor at eye level and slightly tilted.

### ARMS

Relax shoulders and forearms parallel to the floor.

### CHAIR

Should have a backrest and armrests, adjust height.

### LEGS

Thighs parallel to the floor.

### FEET

Parallel to the floor, use a footrest if necessary.

## 5 tips for an ideal standing position

- Shoulders relaxed
- Straight back
- Pelvis in neutral alignment
- Circulation in legs
- Hip, knee and ankle joints aligned with gravity line

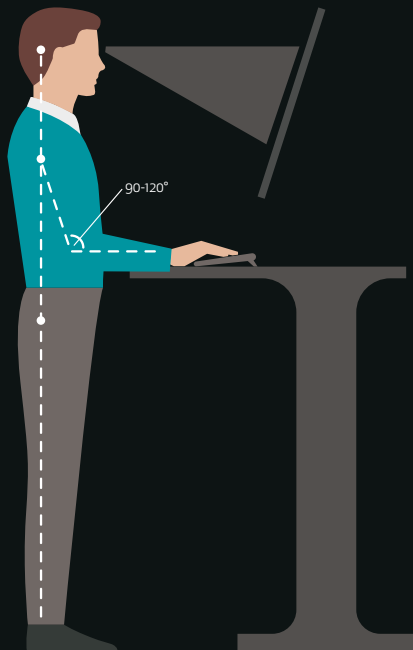

### MONITOR

Tilt your monitor back 10 - 20°.

### ARMS

Maintain keyboard height even with elbows.

### BODY

Change posture every 30 minutes.

### LEGS

Use an anti fatigue mat while standing.

### FEET

A foot rest is essential to shift your weight from one leg to another.

## ■ VESA GAS LIFT ARMS

# M VESA Gas Lift Arm Desk or Wall

Use it on a desk or fix it to a wall

### HIGHLIGHTS:

- Ultimate fit. Improve your monitors movement and overall ergonomics.
- Mounts on your desk or onto a wall.
- Works with most mid size displays up to 32".
- Saves space and holds your cables hidden.

The M VESA Gas Lift Arm Desk or Wall made out of a durable aluminum construction and uses a gas driven suspension technique. This makes the screen "float" and it can then be moved with near zero effort. Sleek and streamlined, the M VESA Gas Lift Arm frees up space and allows positioning of your display for greater productivity.

The unique counterbalance gas technology provides smooth adjustment in any direction. Easily move the screen from landscape to portrait position or move the screen close to the desk, high up, matching almost any wanted working position imaginable. In addition, this version of our Gas Arm can be mounted directly to the wall.

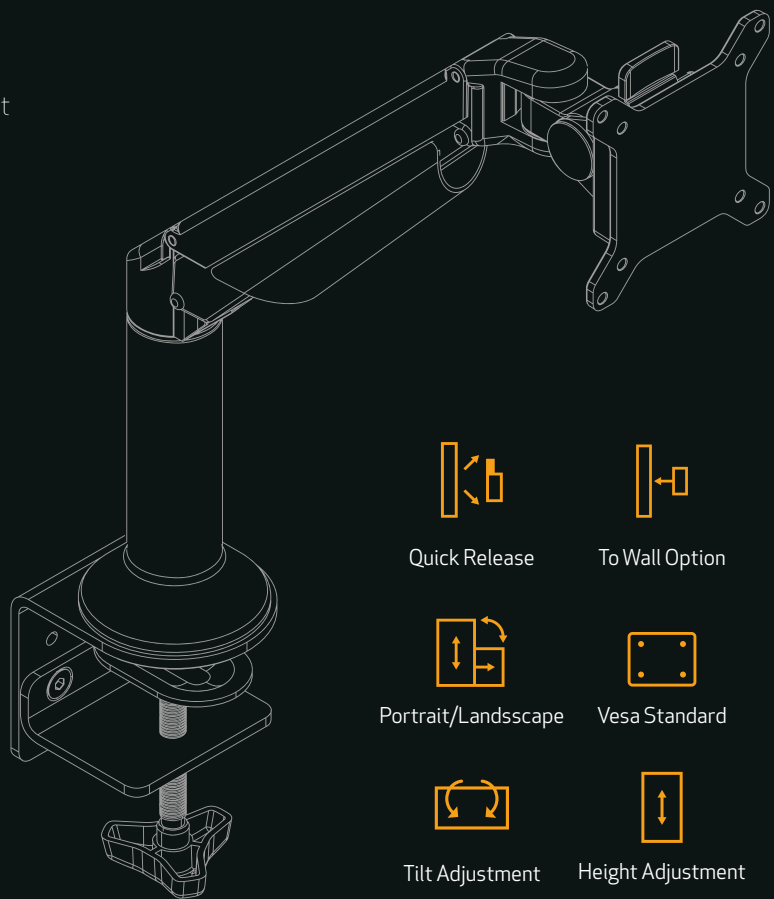

Quick Release



To Wall Option



Portrait/Landscape



Vesa Standard



Tilt Adjustment



Height Adjustment



Cable Management

Ultraflexible, higher, lower  
extended, retracted, tilt  
or 360-degree rotation



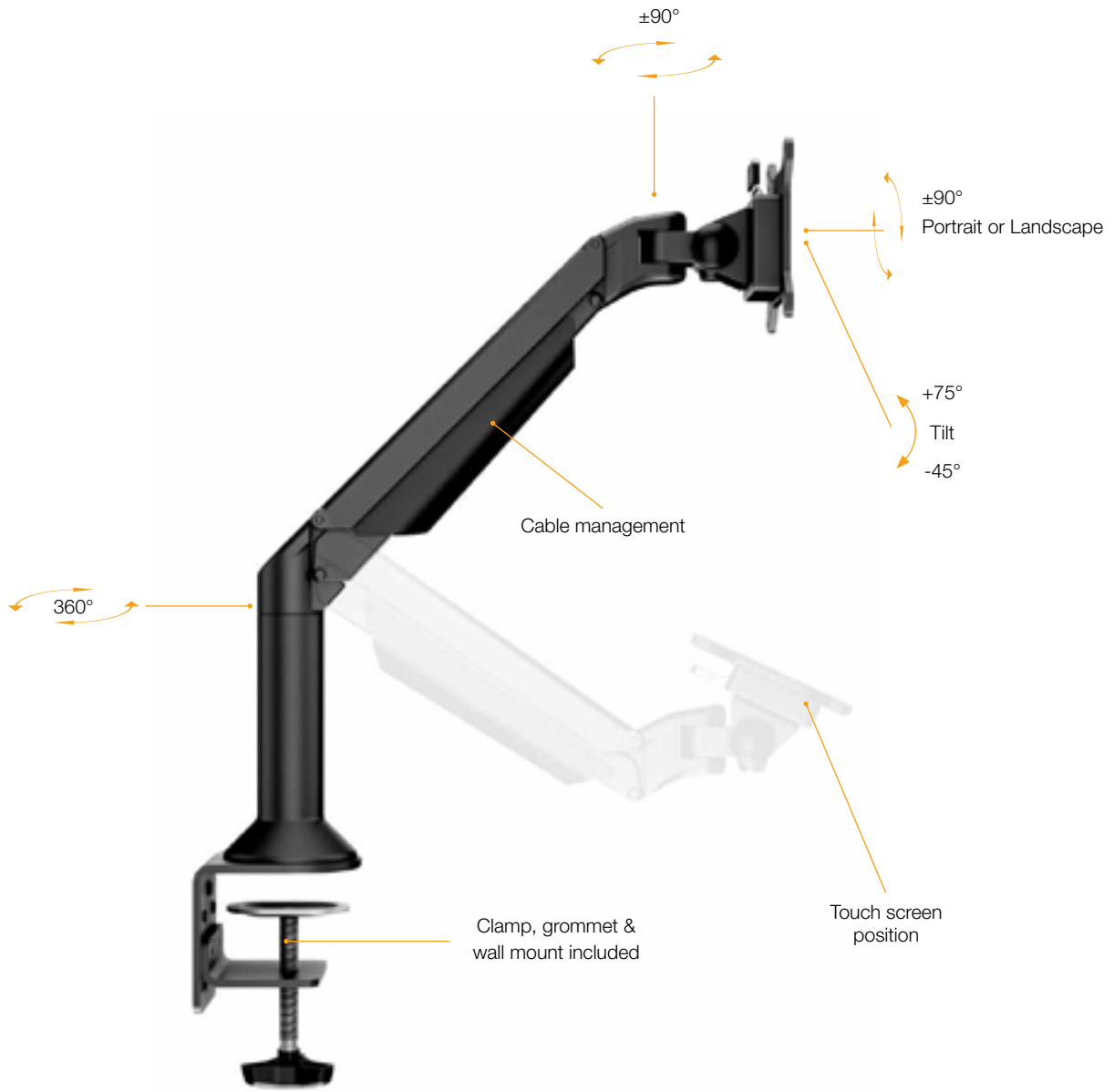

Choose the fixture that suits your work environment

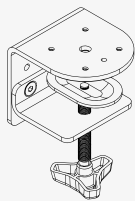

Desk Clamp  
(included)

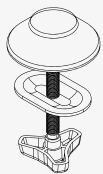

Grommet  
(included)

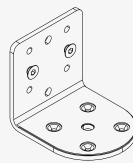

Wall Mount  
(included)



Wall Adapter  
(optional)



M VESA Gas Lift Arm Desk or Wall Basic Silver



M VESA Gas Lift Arm Desk or Wall Basic White



M VESA Gas Lift Arm Desk or Wall Black HD

M VESA Gas Lift Arm Desk or Wall Basic - Specification

Model:	M VESA Gas Lift Arm Desk or Wall Basic Black	M VESA Gas Lift Arm Desk or Wall Basic White	M VESA Gas Lift Arm Desk or Wall Basic Silver	M VESA Gas Lift Arm Desk or Wall Basic Black HD
<b>For screen size:</b>	15-32"	15-32"	15-32"	15-32"
<b>VESA standard:</b>	75x75 100x100 mm	75x75 100x100 mm	75x75 100x100 mm	75x75 100x100 mm
<b>Article No:</b>	7 350 022 739 369	7 350 022 739 376	7 350 022 739 383	7 350 073 732 432
<b>Colour:</b>	Black	White	Silver	Black
<b>Screen weight:</b>	Min. 2 kg - Max. 10 kg	Min. 2 kg - Max. 10 kg	Min. 2 kg - Max. 10 kg	Min. 9 kg — Max. 21 kg
<b>Function:</b>	Gas driven piston	Gas driven piston	Gas driven piston	Gas driven piston
<b>Warranty:</b>	2 years	2 years	2 years	2 years
<b>Weight:</b>	2,4 kg	2,4 kg	2,4 kg	2,4 kg
<b>Tilt angle:</b>	+75 - -45 degrees	+75 - -45 degrees	+75 - -45 degrees	+75 - -45 degrees
<b>Turn angle:</b>	+90 - -90 degrees	+90 - -90 degrees	+90 - -90 degrees	+90 - -90 degrees
<b>Rotate:</b>	90 degrees	90 degrees	90 degrees	90 degrees

# Originals

Our best seller. No time for discomfort.

## HIGHLIGHTS:

- **Flexible fit**  
Move your display to a perfect position, improve your daily use and ergonomics.
- **Better motion**  
This arm easily adjusts monitors up to 32" in size.
- **Space saving**  
Clear your desk and enlarge your working area.
- **Scandinavian design**  
We designed this with both mechanics and aesthetics in mind.
- **Quick release**  
Connects your screen to the arm with a snap.
- **Highest build quality**  
This gas arm is built to last longer than our competitors by passing our 10000 cycle motion test.

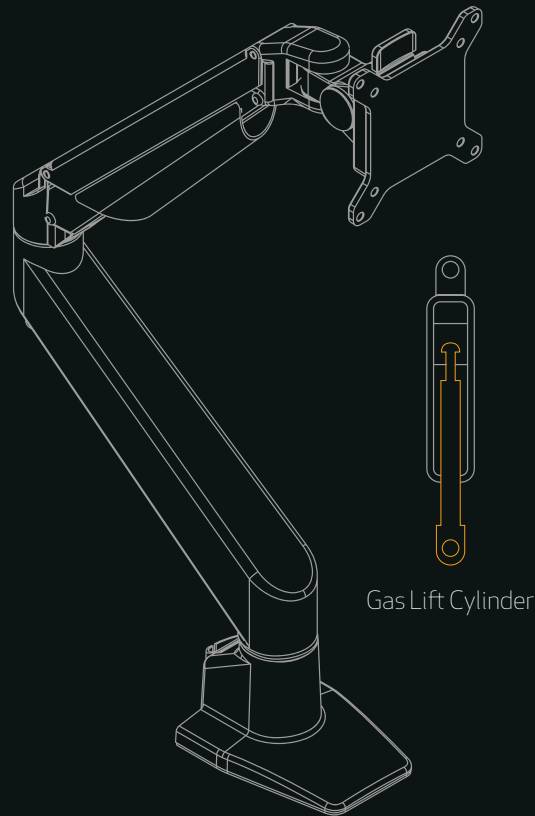

Quick Release



Cable Management



Tilt Adjustment



Portrait/Landscape



Vesa Standard



Height Adjustment

## Designed for everyday viewing comfort

Create the ultimate in monitor flexibility. This Full Motion Universal Desk Mount goes beyond simple movements by offering tool less movement and counter balance weight adjustment. The original M VESA Gas Lift Arm

is made out of a durable aluminum construction and uses a gas driven suspension technique. Always finding your best view, saving desk space and letting you discover your most productive self, the M VESA Gas Lift Monitor Arm

always deliver. Place your screen where you need it for each project, and then reclaim a space full of opportunities by folding the arm and pushing it aside during a much needed screen break.



**Aim for the highest quality**  
*We build our gasarms for 10000 cycle tests*



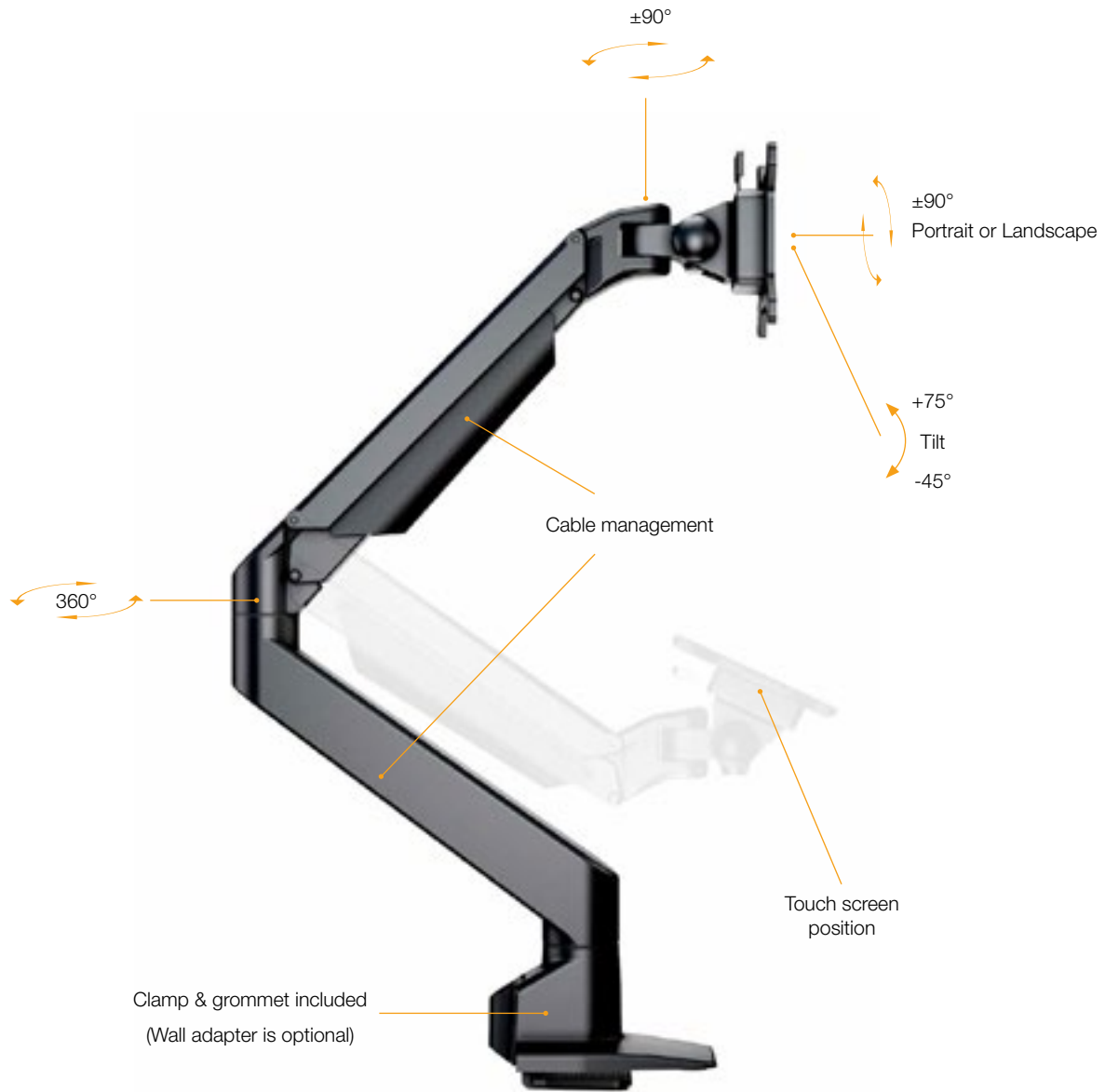

Originals - Specification

Model:	M VESA Gas Lift Arm Single Black	M VESA Gas Lift Arm Single Silver	M VESA Gas Lift Arm Single White
<b>For screen size:</b>	15-32"	15-32"	15-32"
<b>VESA standard:</b>	75x75 100x100 mm	75x75 100x100 mm	75x75 100x100 mm
<b>Article No:</b>	7 350 022 737 174	7 350 022 737 167	7 350 022 737 150
<b>Colour:</b>	Black	Silver	White
<b>Screen weight:</b>	Min. 2 kg – Max. 10 kg	Min. 2 kg – Max. 10 kg	Min. 2 kg – Max. 10 kg
<b>Function:</b>	Gas driven piston	Gas driven piston	Gas driven piston
<b>Warranty:</b>	2 years	2 years	2 years
<b>Weight:</b>	3,4 kg	3,4 kg	3,4 kg
<b>Tilt angle:</b>	+75 – -45 degrees	+75 – -45 degrees	+75 – -45 degrees
<b>Turn angle:</b>	+90 – -90 degrees	+90 – -90 degrees	+90 – -90 degrees
<b>Rotate:</b>	90 degrees	90 degrees	90 degrees





M VESA Gas Lift Arm **Single White HD**



M VESA Gas Lift Arm **Single Silver HD**



M VESA Gas Lift Arm **Single Black HD**

Originals - Specification

Model:	M VESA Gas Lift Arm <b>Single Black HD</b>	M VESA Gas Lift Arm <b>Single Silver HD</b>	M VESA Gas Lift Arm <b>Single White HD</b>
<b>For screen size:</b>	15-32"	15-32"	15-32"
<b>VESA standard:</b>	75x75 100x100 mm	75x75 100x100 mm	75x75 100x100 mm
<b>Article No:</b>	7 350 073 732 449	7 350 073 735 624	7 350 073 735 617
<b>Colour:</b>	Black	Silver	White
<b>Screen weight:</b>	Min. 9 kg — Max. 21 kg	Min. 9 kg — Max. 21 kg	Min. 9 kg — Max. 21 kg
<b>Function:</b>	Gas driven piston	Gas driven piston	Gas driven piston
<b>Warranty:</b>	2 years	2 years	2 years
<b>Weight:</b>	3,4 kg	3,4 kg	3,4 kg
<b>Tilt angle:</b>	+75 — -45 degrees	+75 — -45 degrees	+75 — -45 degrees
<b>Turn angle:</b>	+90 — -90 degrees	+90 — -90 degrees	+90 — -90 degrees
<b>Rotate:</b>	90 degrees	90 degrees	90 degrees

# Large Displays

Add versatility for your large, curved and extra wide displays

## HIGHLIGHTS:

- **Heavy duty**  
Move your large size display to a perfect position.
- **Better motion**  
This arm easily adjusts monitors up to 49" in size (check model and max size).
- **Space saving**  
Clear your desk and enlarge your working area.
- **Scandinavian design**  
We designed this with both mechanics and aesthetics in mind.
- **Quick release**  
Connects your screen to the arm with a snap.
- **Highest build quality**  
This gas arm is built to last longer than our competitors by passing our 10000 cycle motion test.

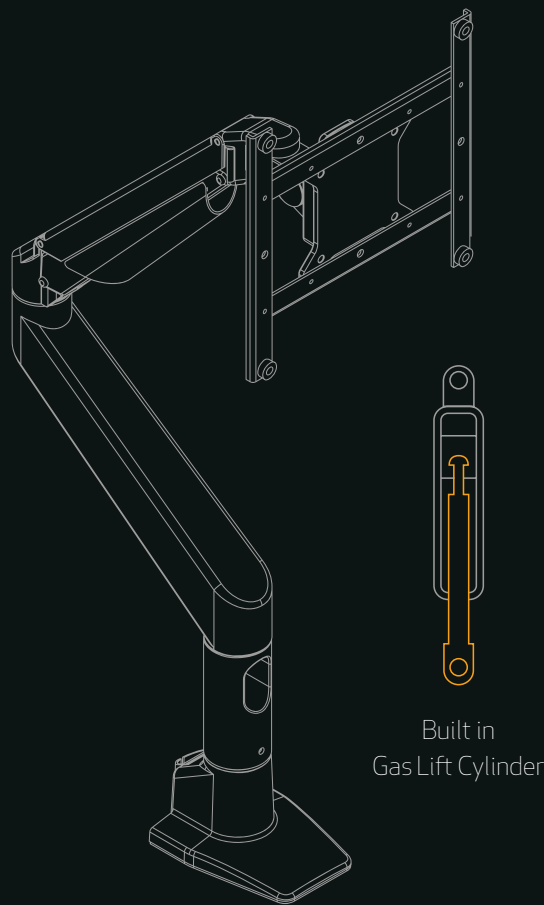

XL Screens



Portrait/Landscape



Vesa Standard



Height Adjustment



Heavy Duty



Cable Management



Tilt



Quick Release

Built in Gas Lift Cylinder

This gas arm is built to last longer than our competitors by passing our 10 000-cycle motion test. This Heavy Duty monitor arm series is cleverly designed and can be used with larger or heavier monitors on the market. All cables route through a smart cable management system solving the problem of messy cords over your desk

space. Finally, a Full Motion Universal Desk Mount goes beyond simple movements by offering tool-less movement and counter balance weight adjustment. The original MVESA Gas Lift Arm XL is made out of aerospace aluminium, it's construction utilizes a gas driven suspension system holding up to a massive 18kg. Always finding your best

view, saving desk space and letting you discover your most productive self, the MVESA Gas Lift Monitor Arm XL series always deliver. Place your screen where you need it for each project, and then reclaim a space full of opportunities by folding the arm and pushing it aside during a much-needed screen.

Perfect for users  
of large size and  
heavier displays



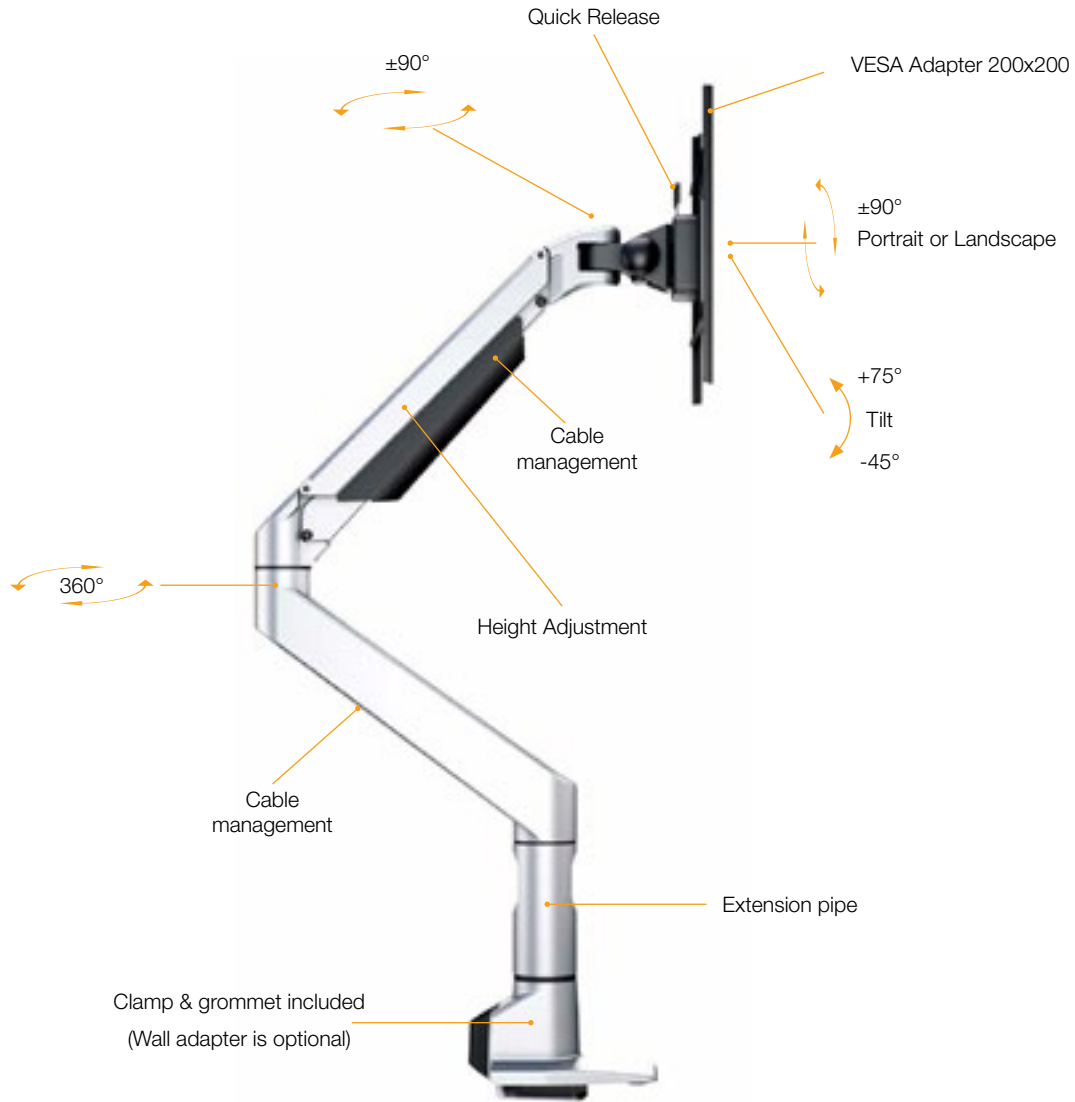

Choose the fixture that suits your work environment

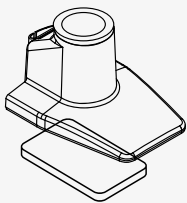

Desk clamp  
(included)

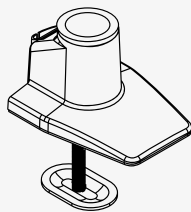

Grommet  
(included)

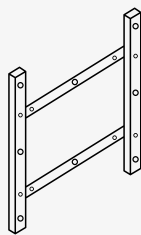

VESA 200x100,  
200x200  
(included)



Extension pipe  
(included)

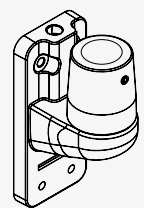

Wall Adapter  
(optional)



VESA 200x200 included

10 cm extension for large size screens

M VESA Gas Lift XL Single White HD



M VESA Gas Lift XL Single Silver HD



M VESA Gas Lift XL Single Black HD

Large Displays - Specification

Model:	M VESA Gas Lift XL Single Black	M VESA Gas Lift XL Single Silver	M VESA Gas Lift XL Single White	M VESA Gas Lift XL Single Black HD	M VESA Gas Lift XL Single Silver HD	M VESA Gas Lift XL Single White HD
<b>For screen size:</b>	15"-38"	15"-38"	15"-38"	15"-49"	15"-49"	15"-49"
<b>VESA standard:</b>	75x75 100x100 200x200 mm	75x75 100x100 200x200 mm	75x75 100x100 200x200 mm	75x75, 100x100 & 200x200 mm	75x75, 100x100 & 200x200 mm	75x75, 100x100 & 200x200 mm
<b>Article No:</b>	7 350 073 737 093	7 350 073 737 109	7 350 073 737 116	7 350 073 737 123	7 350 073 737 130	7 350 073 737 147
<b>SKU included:</b>	7174+5396+2548	7174+5396+2548	7174+5396+2548	2449+5396+2548	2449+5396+2548	2449+5396+2548
<b>Colour:</b>	Black	Silver	White	Black	Silver	White
<b>Screen weight:</b>	Min. 2 kg - Max. 10 kg	Min. 2 kg - Max. 10 kg	Min. 2 kg - Max. 10 kg	Min. 9 kg — Max. 18 kg	Min. 9 kg — Max. 18 kg	Min. 9 kg — Max. 18 kg
<b>Function:</b>	Gas driven piston	Gas driven piston	Gas driven piston	Gas driven piston	Gas driven piston	Gas driven piston
<b>Warranty:</b>	2 years	2 years	2 years	2 years	2 years	2 years
<b>Weight:</b>	3,4 kg	3,4 kg	3,4 kg	3,4 kg	3,4 kg	3,4 kg
<b>Tilt angle:</b>	+75 — -45 degrees	+75 — -45 degrees	+75 — -45 degrees	+75 — -45 degrees	+75 — -45 degrees	+75 — -45 degrees
<b>Turn angle:</b>	+90 — -90 degrees	+90 — -90 degrees	+90 — -90 degrees	+90 — -90 degrees	+90 — -90 degrees	+90 — -90 degrees
<b>Rotate:</b>	90 degrees	90 degrees	90 degrees	90 degrees	90 degrees	90 degrees

# Dual Monitor

## Increase effectivity

Reclaim desk space with dual monitors

### HIGHLIGHTS:

- **Double your display area**  
Perfectly aligns two LCD displays side by side, improve your daily use and increase efficiency.
- **Space saving**  
Clear your desk and enlarge your working area.
- **Better motion**  
This arm easily adjusts monitors up to 32" in size.
- **Scandinavian design**  
We designed this with both mechanics and aesthetics in mind.
- **Highest build quality**  
Our gas arms are built to last longer than our competitors by passing our 10000 cycle motion test.

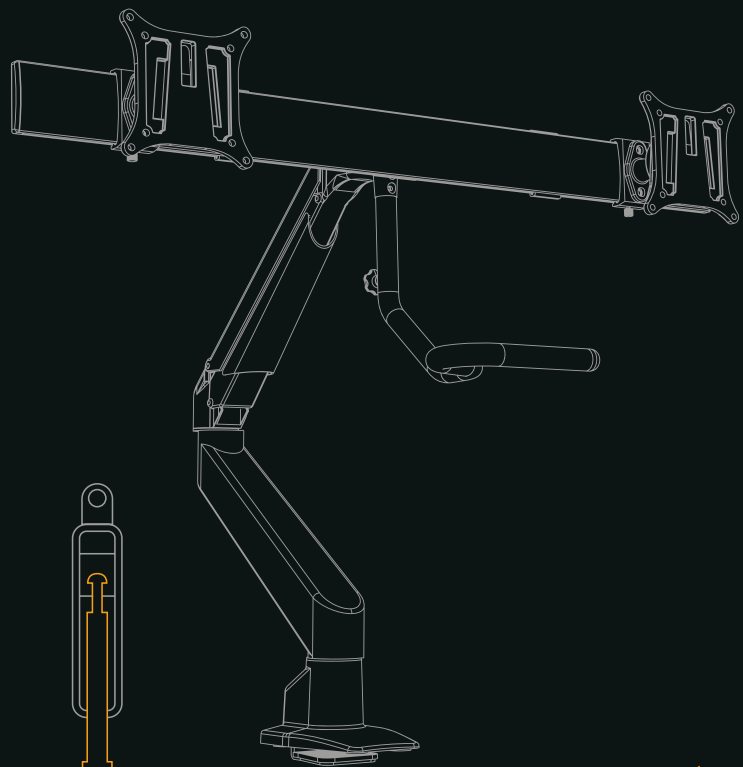

Built in  
Gas Lift Cylinder



Portrait/Landscape



Cable Management



Vesa Standard



Tilt



Height Adjustment



Quick Release



Dual Monitor

Did you know using dual monitors can increase productivity by up to 30%? In tests it has been found that considerable time can be saved if an employee uses more screens with documents open simultaneously, rather than opening and closing documents on a single screen. This low profile dual screen monitor arm series is aimed

to keep employees efficient as well as returning precious space. So, let's start reclaiming that desk space and get everyone more efficient while doing it. Create a fully adjustable dual monitor configuration that lifts both LCD screens simultaneously. Providing a compact range of motion and optimal ergonomic alignment.



Perfect for any user  
who multitask or use  
multiple documents  
open at one given time





M VESA Gas Lift Arm Single Black with Duo Crossbar



M VESA Gas Lift Arm Single Silver with Duo Crossbar



M VESA Gas Lift Arm Single White with Duo Crossbar

Dual Monitor - Specification

Model:	M VESA Gas Lift Arm Single Black with Duo Crossbar	M VESA Gas Lift Arm Single Silver with Duo Crossbar	M VESA Gas Lift Arm Single White with Duo Crossbar	M VESA Gas Lift Arm Single Black HD with Duo Crossbar
<b>For screen size:</b>	15-32"	15-32"	15-32"	15-32"
<b>VESA standard:</b>	75x75 100x100 mm	75x75 100x100 mm	75x75 100x100 mm	75x75 100x100 mm
<b>Article No:</b>	7 350 073 735 921	7 350 073 735 938	7 350 073 735 945	7 350 073 735 952
<b>Colour:</b>	Black	Silver	White	Black
<b>Screen weight:</b>	Min. 2 kg — Max. 10 kg <small>As crossbar weight is 1.75 kg, max screen weight is 8.25 kg</small>	Min. 2 kg — Max. 10 kg <small>As crossbar weight is 1.75 kg, max screen weight is 8.25 kg</small>	Min. 2 kg — Max. 10 kg <small>As crossbar weight is 1.75 kg, max screen weight is 8.25 kg</small>	Min. 9 kg — Max. 21 kg
<b>Function:</b>	Gas driven piston	Gas driven piston	Gas driven piston	Gas driven piston
<b>Warranty:</b>	2 years	2 years	2 years	2 years
<b>Weight:</b>	3.4 kg + 1.75 kg	3.4 kg + 1.75 kg	3.4 kg + 1.75 kg	3.4 kg + 1.75 kg
<b>Tilt angle:</b>	+75 — -45 degrees	+75 — -45 degrees	+75 — -45 degrees	+75 — -45 degrees
<b>Turn angle:</b>	+90 — -90 degrees	+90 — -90 degrees	+90 — -90 degrees	+90 — -90 degrees
<b>Rotate:</b>	90 degrees	90 degrees	90 degrees	90 degrees





M VESA Gas Lift Arm Single with Duo Crossbar 2 Black



M VESA Gas Lift Arm Single with Duo Crossbar 2 Silver



M VESA Gas Lift Arm Single with Duo Crossbar 2 White

### Dual Monitor- Specification

Model:	M VESA Gas Lift Arm with Duo Crossbar 2 Black	M VESA Gas Lift Arm with Duo Crossbar 2 Silver	M VESA Gas Lift Arm with Duo Crossbar 2 White
For screen size:	15" - 28"	15" - 28"	15" - 28"
VESA standard:	75x75 100x100 mm	75x75 100x100 mm	75x75 100x100 mm
Article No:	7 350 073 736 355	7 350 073 736 362	7 350 073 736 379
Colour:	Black	Silver	White
Screen weight:	Min. 2 x 2 kg - Max. 2 x 7 kg	Min. 2 x 2 kg - Max. 2 x 7 kg	Min. 2 x 2 kg - Max. 2 x 7 kg
Function:	Gas driven piston	Gas driven piston	Gas driven piston
Weight:	4.1 kg	4.1 kg	4.1 kg
Tilt angle:	+25 - -25°	+25 - -25°	+25 - -25°
Turn angle:	+90 - -90°	+90 - -90°	+90 - -90°
Rotate:	360°	360°	360°
Measurements:	665x120x515 (D*W*H)	665x120x515 (D*W*H)	665x120x515 (D*W*H)
Adjustable height from table top to VESA plate center:	175 - 515mm	175 - 515mm	175 - 515mm
Installation:	Desk clamp, adjustable 10 - 50mm	Desk clamp, adjustable 10 - 50mm	Desk clamp, adjustable 10 - 50mm
Warranty:	2 years	2 years	2 years

# Dual Monitor Side By Side

Optimize space, productivity and comfort with dual monitors side by side

## HIGHLIGHTS:

- **Super flexible**  
Designed for side by side, low, high screen angle views.
- **Space saving**  
Clears your desk, creates extra workspace.
- **Better motion**  
This arm positions two monitors up, down, landscape or portrait.
- **Scandinavian design**  
We designed this with both mechanics and aesthetics in mind.
- **Highest build quality**  
Our gas arms are built to last longer than our competitors by passing our 10000 cycle motion test.

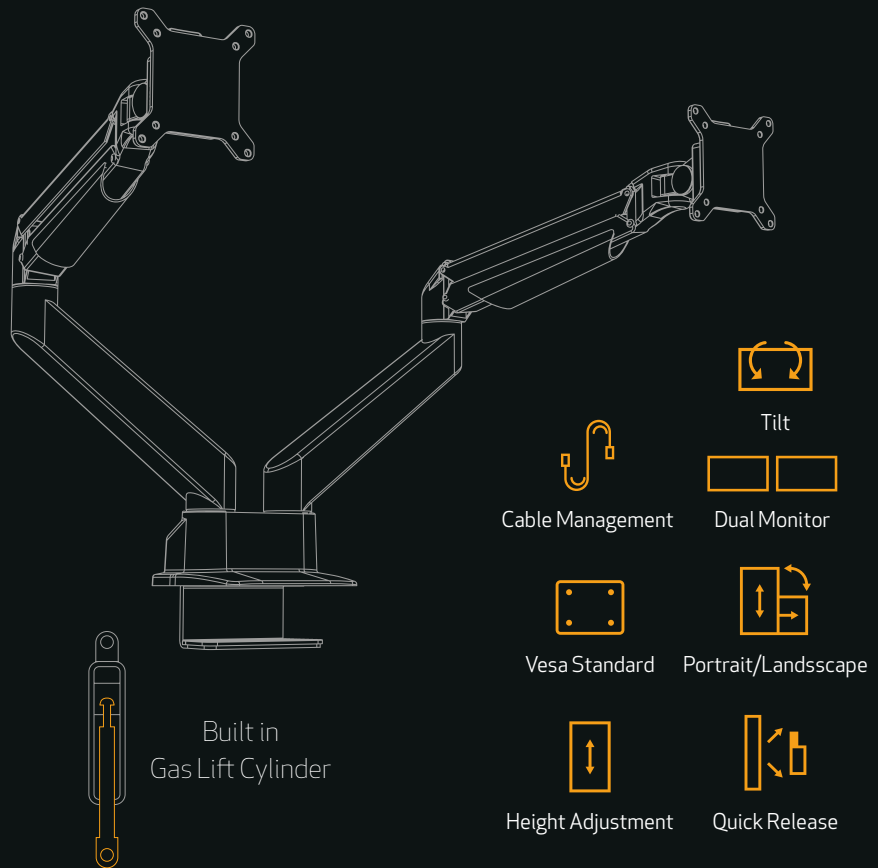

Increasingly, computer users are adding second monitors to their desk setups to allow for easier task switching and comparison between multiple files. Actually, using two displays side by side, according to independent tests, can increase productivity by up to 30%. Our range of side by side dual monitor

display, effortlessly adjusts to suit your needs. Featuring extendable and retractable arms which tilt to alter reading angles, not to mention rotating to either portrait or landscape modes. Having each monitor on individual gas driven arm allows one screen in landscape and the other in portrait as well

as having the displays at a different distance depending how your eyes are responding. Our Side by side dual screen monitor arm series is aimed to keep coworkers efficient as well as clear desk space.



Perfectly suited for users who require unparalleled range of motion or use multiple applications at once during their daily work

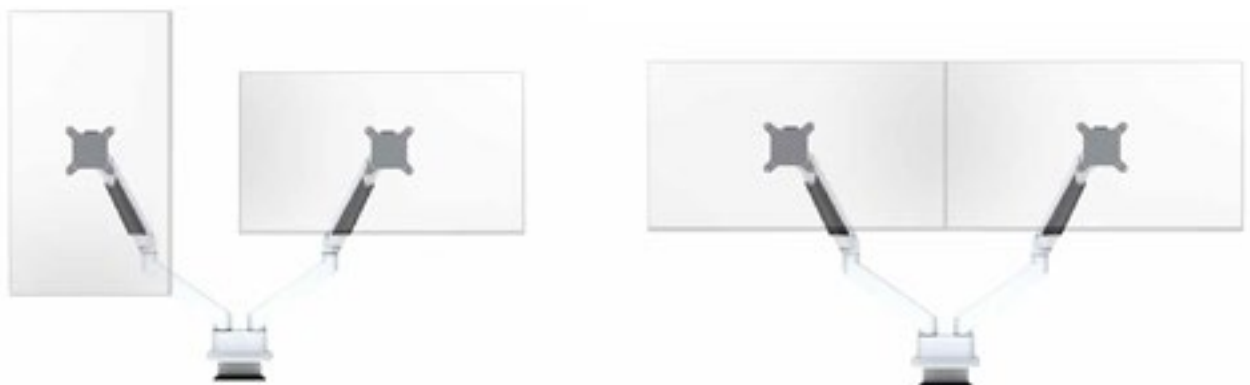

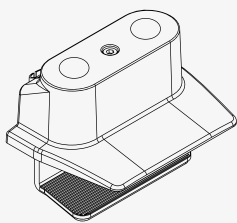
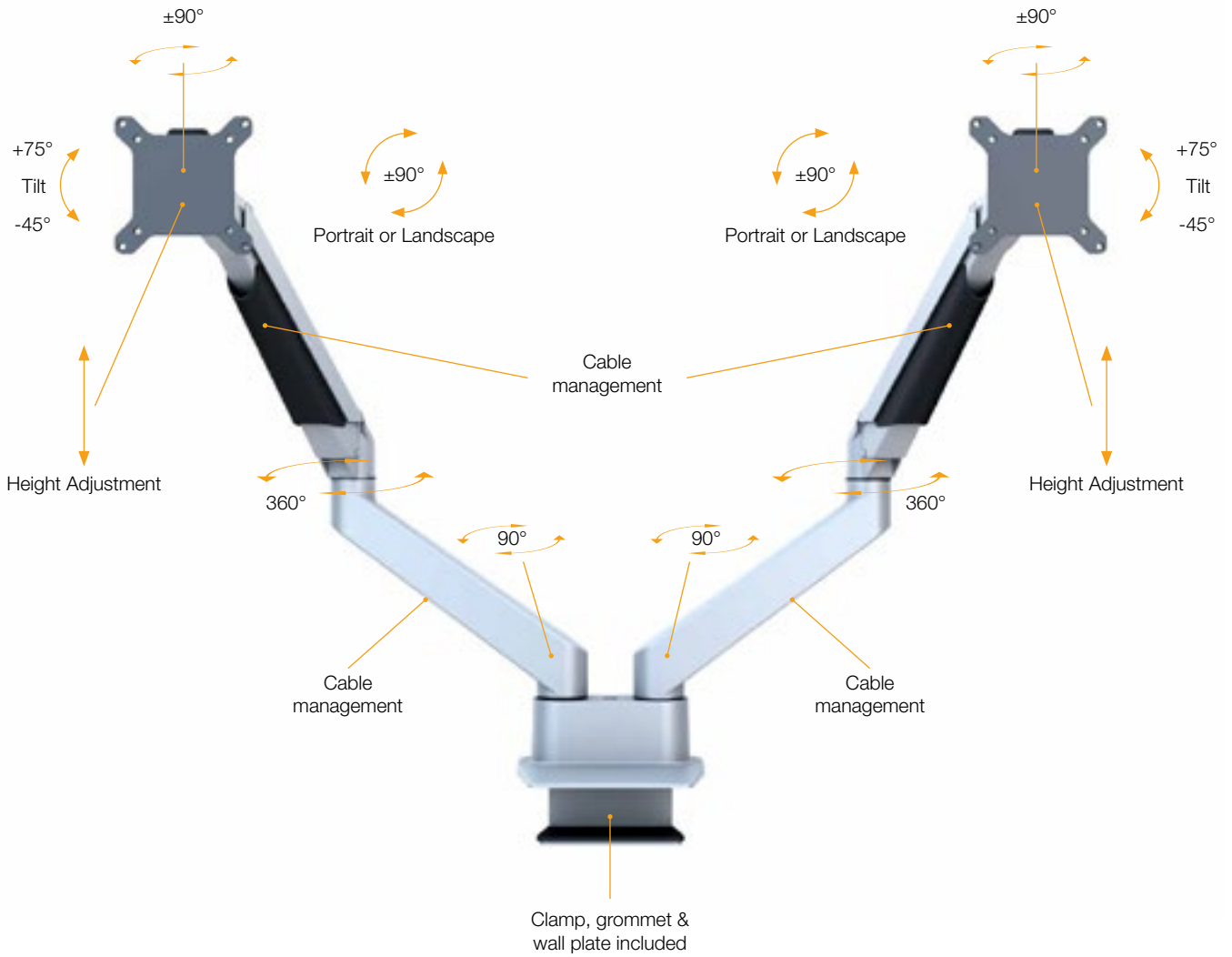

Desk clamp (included)

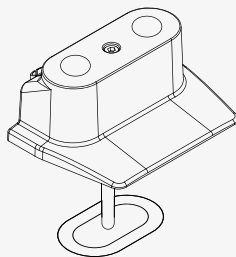

Grommet (included)

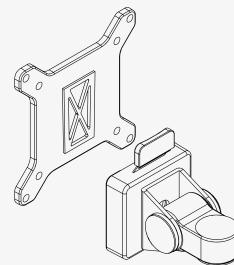

Quick release (included)



M VESA Gas Lift Arm Dual Side by Side Black



M VESA Gas Lift Arm Dual Side by Side White



M VESA Gas Lift Arm Dual Side by Side Silver

### Dual Monitor Side by Side - Specification

Model:	M VESA Gas Lift Arm Dual Side by Side Black	M VESA Gas Lift Arm Dual Side by Side White	M VESA Gas Lift Arm Dual Side by Side Silver	M VESA Gas Lift Arm Dual Side by Side Black HD
Article No:	7 350 073 733 965	7 350 073 733 989	7 350 073 733 972	7 350 073 734 207
Colour:	Black	White	Silver	Black
Surface Finish:	Powder coating	Powder coating	Powder coating	Powder coating
Material:	Aluminum, Steel	Aluminum, Steel	Aluminum, Steel	Aluminum, Steel
For screen size:	15"-32" * depending on screen type	15"-32" * depending on screen type	15"-32" * depending on screen type	15-32"
VESA standard:	75x75 100x100 mm	75x75 100x100 mm	75x75 100x100 mm	75x75 100x100 mm
Screen weight:	Min:2 kg Max. 10 kg	Min:2 kg Max. 10 kg	Min:2 kg Max. 10 kg	Min:9 kg - Max. 21 kg
Function:	Gas driven piston	Gas driven piston	Gas driven piston	Gas driven piston
Product size:	1300x650x605 mm	1300x650x605 mm	1300x650x605 mm	1300*650*605mm
Weight:	6.8 kg	6.8 kg	6.8 kg	6.8 kg
Tilt angle:	+75 - 45 degrees	+75 - 45 degrees	+75 - 45 degrees	+75 - 45 degrees
Turn angle:	+90 - 90 degrees	+90 - 90 degrees	+90 - 90 degrees	+90 - 90 degrees
Rotate:	90 degrees	90 degrees	90 degrees	90 degrees
Installation:	Desk clamp, adjustable 10-50 mm	Desk clamp, adjustable 10-50 mm	Desk clamp, adjustable 10-50 mm	Desk clamp, adjustable 10-85 mm
Cable Management:	Yes	Yes	Yes	Yes
Warranty:	2 years	2 years	2 years	2 years

# Multi Monitor Solutions

## Dual & Quad

Multiple monitors can streamline your work and increase your work productivity

### HIGHLIGHTS:

- **Super flexible**  
Two or four monitors independently adjustable to fit your daily needs.
- **Space saving**  
Clears your desk and creates extra workspace while maximizing comfort.
- **Heavy duty**  
Single Pole with heavy duty clamp.
- **Well designed**  
3rd generation Gas arm designed with both mechanics and aesthetics in mind.
- **Highest build quality**  
Our gas arms are built to last longer than our competitors by passing our 10000 cycle motion test.

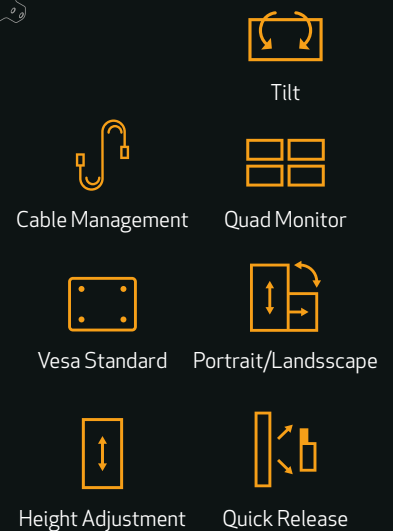
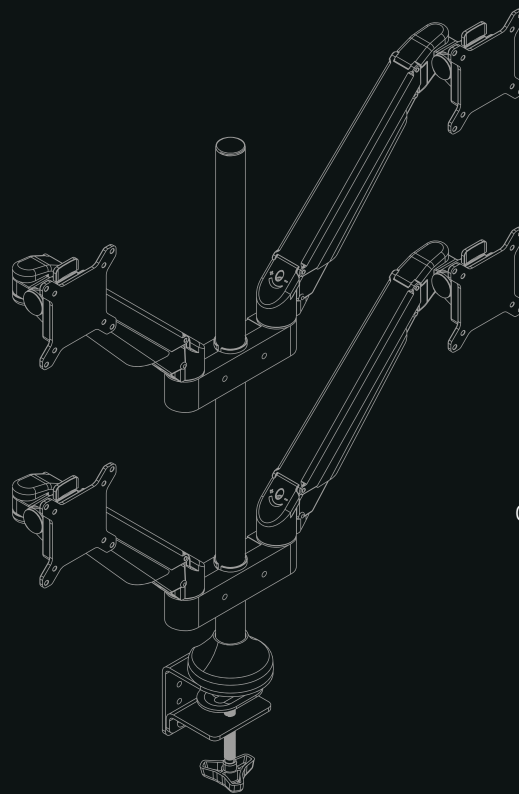

We believe the M VESA Gas Lift Arm Dual/Quad series to be one of the world's best multi monitor arm systems. The durable system made out of mainly aluminum can safely secure two or up to four monitors at once and with its accessories it can accommodate various configurations. Utilizing the Multibrackets new generation of Quick release monitor arms it provides

cutting edge features for any IT department to reduce downtime if monitor service is needed. M VESA Gas Lift Arm Dual/Quad is perfect for the modern workplace and encourages flexibility and collaboration at the workstation. After installation one can easily set each monitor at an optimal distance and height, this increases usable desk space and allows the user to work in

a healthy posture throughout the day even with as much as 4 different monitors at the desk. The built in innovative cable management system will guarantee that your desk remains uncluttered. With the aim to be simple to install, easy to use, this series provides an overall reduced cost of ownership.

Maximize  
desk space  
and improve  
productivity





M VESA Gas Lift Arm Dual Black



M VESA Gas Lift Arm Dual Silver



M VESA Gas Lift Arm Dual White

Multi Monitor Solutions - Dual - Specification

Model:	M VESA Gas Lift Arm Dual Black	M VESA Gas Lift Arm Dual Silver	M VESA Gas Lift Arm Dual White	M VESA Gas Lift Arm Dual Black HD
<b>For screen size:</b>	15-(32")*	15-(32")*	15-(32")*	15-(32")*
<b>VESA standard:</b>	75x75 100x100 mm	75x75 100x100 mm	75x75 100x100 mm	75x75 100x100 mm
<b>Article No:</b>	7 350 022 737 204	7 350 022 737 198	7 350 022 737 181	7 350 073 732 593
<b>Colour:</b>	Black	Silver	White	Black
<b>Screen weight:</b>	Min. 2 kg Max. 10 kg	Min. 2 kg Max. 10 kg	Min. 2 kg Max. 10 kg	Min. 9 kg Max. 21 kg
<b>Function:</b>	Gas driven piston	Gas driven piston	Gas driven piston	Gas driven piston
<b>Warranty:</b>	2 years	2 years	2 years	2 years
<b>Weight:</b>	10,3 kg	10,3 kg	10,3 kg	10,3 kg
<b>Tilt angle:</b>	+75 - 45 degrees	+75 - 45 degrees	+75 - 45 degrees	+75 - 45 degrees
<b>Turn angle:</b>	+90 - 90 degrees	+90 - 90 degrees	+90 - 90 degrees	+90 - 90 degrees
<b>Rotate:</b>	90 degrees	90 degrees	90 degrees	90 degrees





M VESA Gas Lift Arm Quad Black



M VESA Gas Lift Arm Quad Silver



M VESA Gas Lift Arm Quad White

Multi Monitor Solutions - Quad - Specification

Model:	M VESA Gas Lift Arm Quad Black	M VESA Gas Lift Arm Quad Silver	M VESA Gas Lift Arm Quad White	M VESA Gas Lift Arm Quad Black HD
For screen size:	15 - (32")	15 - (32")	15 - (32")	15 - (32")
VESA standard:	75x75 100x100 mm	75x75 100x100 mm	75x75 100x100 mm	75x75 100x100 mm
Article No:	7 350 022 737 235	7 350 022 737 228	7 350 022 737 211	7 350 073 732 609
Colour:	Black	Silver	White	Black
Screen weight:	Min. 2 kg Max. 10 kg	Min. 2 kg Max. 10 kg	Min. 2 kg Max. 10 kg	Min. 9 kg Max. 21 kg
Function:	Gas driven piston	Gas driven piston	Gas driven piston	Gas driven piston
Warranty:	2 years	2 years	2 years	2 years
Weight:	10,3 kg	10,3 kg	10,3 kg	10,3 kg
Tilt angle:	+75 - 45 degrees	+75 - 45 degrees	+75 - 45 degrees	+75 - 45 degrees
Turn angle:	+90 - 90 degrees	+90 - 90 degrees	+90 - 90 degrees	+90 - 90 degrees
Rotate:	90 degrees	90 degrees	90 degrees	90 degrees

# **Accessories**

## *Gas Lift Arms*



## M Laptop Holder Gaslift Arm

Lets start utilizing your notebook as a second screen. Add this accessory to a gaslift arm and start position your notebook computer where you need it most.

Works with most traditional laptops or the convertible notebooks, in either tablet or laptop mode.

## Give your gaslift more Flexibility

Multibrackets complete selection of accessories:  
*Add-ons to customize your mount*

### Lets find the right accessories to your work desk

Multibrackets complete selection of accessories and optional add ons for our Gas arm series. Lets customize your Multibrackets monitor mount to fit you and your workspace even better.

With one of the most comprehensive and wide assortments of Gasarms we also strive to have a wide assortment of accessories to add individualized freedom and flexibility even further.

This assortment is updated on a continuous basis, check online for the latest updates.





<b>Model:</b>	M VESA 75 100 Duo Crossbar with handle Black	M VESA 75 100 Duo Crossbar with handle Silver	M VESA 75 100 Duo Crossbar with handle White	M VESA 75 100 Duo Quick Release Plate Black
<b>Article No:</b>	7 350 073 734 894	7 350 073 734 900	7 350 073 734 917	7 350 073 730 711
<b>Suitable for:</b>	M VESA Gas Lift Arm Single	M VESA Gas Lift Arm Single	M VESA Gas Lift Arm Single	M VESA Gas Lift Arm Single
<b>For screen size:</b>	2 x 17-23"	2 x 17-23"	2 x 17-23"	2 x 17-23"
<b>Colour:</b>	Black	Silver	White	Black
<b>Weight:</b>	1.75 kg	1.75 kg	1.75 kg	2 kg
<b>Warranty:</b>	5 years	5 years	5 years	5 years



<b>Model:</b>	M Duo Deskmount Black	M Duo Deskmount Silver	M Duo Deskmount White	M Gas Lift VESA Adapter 200x200
<b>Article No:</b>	7 350 073 730 704	7 350 073 730 896	7 350 073 730 902	7 350 073 732 548
<b>Suitable for:</b>	M VESA Gas Lift Arm Single	M VESA Gas Lift Arm Single	M VESA Gas Lift Arm Single	M VESA Gas Lift Arm Series with VESA mounting
<b>Colour:</b>	Black	Silver	White	Silver
<b>Weight:</b>	2 kg	2 kg	2 kg	0.35 kg
<b>Warranty:</b>	5 years	5 years	5 years	5 years



<b>Model:</b>	M Extension Pipe 10cm for M VESA Gas Lift Arm Single Black	M Extension Pipe 10cm for M VESA Gas Lift Arm Single Silver	M Extension Pipe 10cm for M VESA Gas Lift Arm Single White	M VESA 75 100 Quick Release Plate
<b>Article No:</b>	7 350 073 735 396	7 350 073 735 402	7 350 073 735 419	7 350 073 738 014
<b>Suitable for:</b>	M VESA Gas Lift Arm Single / Single HD	M VESA Gas Lift Arm Single / Single HD	M VESA Gas Lift Arm Single / Single HD	M VESA Gas Lift Arm Single / Single HD
<b>Colour:</b>	Black	Silver	White	Black
<b>Weight:</b>	0.35 kg	0.35 kg	0.35 kg	0.1 kg
<b>Warranty:</b>	5 years	5 years	5 years	5 years



Model:	M Wall Adapter Single Black	M Wall Adapter Single Silver	M Wall Adapter Single White
Article No:	7 350 073 731 381	7 350 073 731 374	7 350 073 731 367
Suitable for:	M VESA Gas Lift Arm Single	M VESA Gas Lift Arm Single	M VESA Gas Lift Arm Single
Colour:	Black	Silver	White
Weight:	0.6 kg	0.6 kg	0.6 kg
Warranty:	5 years	5 years	5 years



Model:	M Wall Adapter Basic Black	M Wall Adapter Basic Silver	M Wall Adapter Basic White
Article No:	7 350 073 731 350	7 350 073 731 343	7 350 073 731 336
Suitable for:	M VESA Gas Lift Arm Basic	M VESA Gas Lift Arm Basic	M VESA Gas Lift Arm Basic
Colour:	Black	Silver	White
Weight:	0.6 kg	0.6 kg	0.6 kg
Warranty:	5 years	5 years	5 years



Model:	M Laptop Holder Gas Lift Arm Black	M Laptop Holder Gas Lift Arm Silver	M Laptop Holder Gas Lift Arm White
Article No:	7 350 022 737 525	7 350 022 737 532	7 350 022 737 518
Suitable for:	M VESA Gas Lift Arm or any other VESA mount	M VESA Gas Lift Arm or any other VESA mount	M VESA Gas Lift Arm or any other VESA mount
Colour:	Black	Silver	White
Weight:	0.5 kg	0.5 kg	0.5 kg
Warranty:	5 years	5 years	5 years

## ■ VESA GAS LIFT ARMS

# M Vesa Gas Lift Single & Dual

Battle today's fast paced environments with increased efficiency and reclaimed desk space

### HIGHLIGHTS:

- Exceptional range of flexible motion featuring 90° to +90° tilt, 180° swivel, and 180° rotation.
- Monitor can be placed in portrait or landscape.
- High grade aluminum arm features a stylish anti scratch surface.
- Smart built in cable management system.
- Supports monitors with VESA 75/100 from 1 kg up to 9 kg.
- Clamp and grommet included as standard.
- Easy installation and tool less monitor placement with perfect counterbalance presentation in all directions.

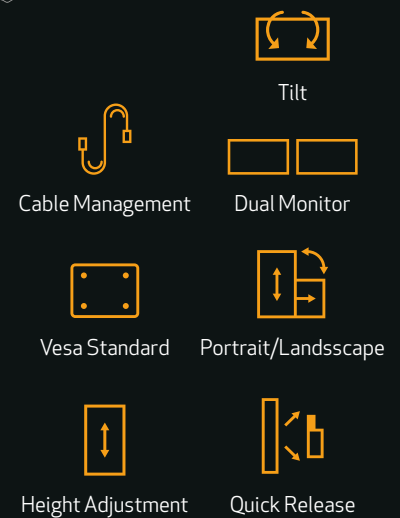
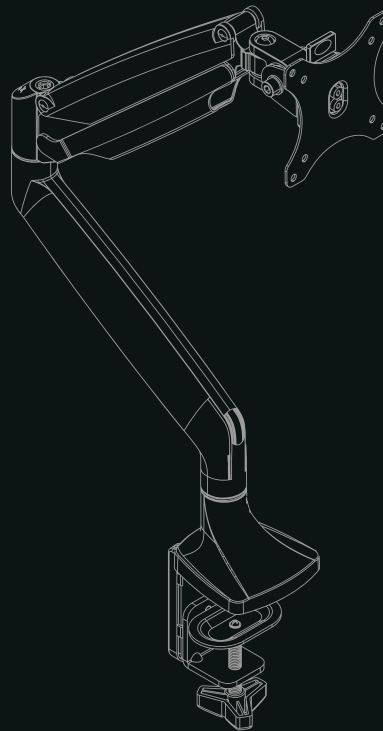

Our gas arms are built to last longer than our competitors by passing our 10 000 cycle motion test. We believe the M VESA Gas Lift Arm Dual/Quad series to be one of the world's best multi monitor arm systems. The durable system is mainly constructed from aluminium and can safely secure two or up to four monitors at once with accessories in various configurations. Utilizing Multibrackets new generation

of Quick release monitor arms it provides cutting edge features for any IT department to reduce downtime if monitor service and maintenance is needed. M VESA Gas Lift Arm Dual/Quad is perfect for the modern workplace and encourages flexibility and collaboration at the workstation. After installation one can easily set each monitor at an optimal distance and height. This also increase usable desk

space and allows the user to work in a healthy posture throughout the day even with as many as 4 different monitors on the desk. The built in innovative cable management system will guarantee that your desk remains uncluttered. With the aim to be simple to install, easy to use, this series provides an overall reduced cost of ownership.

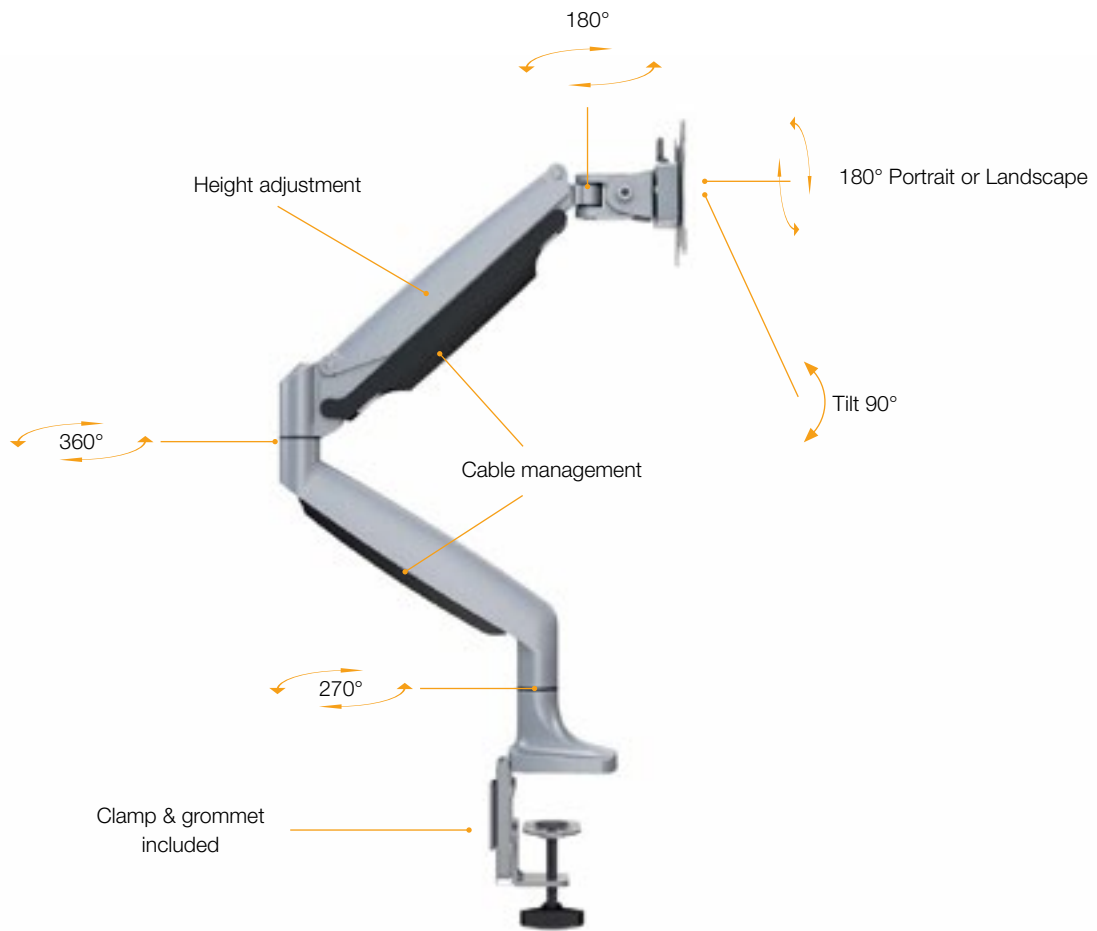

## Unparalleled range of motion

*The ideal solution for offices, classrooms, foyers or any other place you may need.*





M Deskmount Gas Spring **Single Black**



M Deskmount Gas Spring **Single Silver**



M Deskmount Gas Spring **Single White**

**M Deskmount Gas Spring Single - Specification**

Model:	M Deskmount Gas Spring <b>Single Black</b>	M Deskmount Gas Spring <b>Single Silver</b>	M Deskmount Gas Spring <b>Single White</b>
Article No:	7 350 073 733 262	7 350 073 733 255	7 350 073 737 079
Colour:	Black	Silver	White
For screen size:	15-27"	15-27"	15-27"
Universal & VESA standard:	75x75 100x100 mm	75x75 100x100 mm	75x75 100x100 mm
Material	Aluminum, Steel	Aluminum, Steel	Aluminum, Steel
Weight	3.4 kg	3.4 kg	3.4 kg
Max load:	Min load: 1 kg - Max load: 9 kg	Min load: 1 kg - Max load: 9 kg	Min load: 1 kg - Max load: 9 kg
Height:	170 - 505mm Adjustable from table top to VESA plate center	170 - 505mm Adjustable from table top to VESA plate center	170 - 505mm Adjustable from table top to VESA plate center
Tilt:	Yes	Yes	Yes
For desktop width:	10 - 85mm	10 - 85mm	10 - 85mm
Warranty:	2 years	2 years	2 years





M Deskmount Gas Spring Dual Black



M Deskmount Gas Spring Dual Silver



M Deskmount Gas Spring Dual White

### M Deskmount Gas Spring Dual - Specification

Model:	M Deskmount Gas Spring Dual Black	M Deskmount Gas Spring Dual Silver	M Deskmount Gas Spring Dual White
Article No:	7 350 073 733 286	7 350 073 733 279	7 350 073 737 086
Colour:	Black	Silver	White
For screen size:	15-27"	15-27"	15-27"
Universal & VESA standard:	75x75 100x100 mm	75x75 100x100 mm	75x75 100x100 mm
Material	Aluminum, Steel	Aluminum, Steel	Aluminum, Steel
Weight	6 kg	6 kg	6 kg
Max load:	Min load: 1 kg - Max load: 9 kg	Min load: 1 kg - Max load: 9 kg	Min load: 1 kg - Max load: 9 kg
Adjustable height from table top to VESA plate center:	170 - 505mm	170 - 505mm	170 - 505mm
Tilt:	Yes	Yes	Yes
For desktop width:	10 - 85mm	10 - 85mm	10 - 85mm
Warranty:	2 years	2 years	2 years

# Deskstands/Workstations

## Elevate productivity

Smart Workstation solutions promotes long term healthy computing

### HIGHLIGHTS:

- **Super flexible**  
Individually fine tune your monitor for how you work best.
- **Space saving**  
Clears your desk and creates extra workspace while maximizing comfort.
- **Stability & durability**  
Best in class stability & tested over 10000 times.
- **Effortless and Virtually Silent**  
No cranking, no clicking, your display will move effortlessly.
- **Build quality**  
Our Workstations are built to last longer than our competitors.



Our Workstations are built to last longer than our competitors. Whether you are sitting or standing our wall or desk mounted counterbalanced Workstation Arms let you position your monitor in the most ideal ergonomic position for you. For both Workstation Arms and Easy Stand there are no fixed heights, no cranking, no clicking unlike many other products out there. By elevating your monitor or monitors, you will free up the space below for other important items. That means you will have more

space for multitasking. Another benefit is the added viewing capabilities. Have you ever had to share a presentation at your desk or perhaps with a patient (medical applications)? Having a Workstation monitor arm can make that kind of viewing experience a whole lot more enjoyable.

Easy Stand Workstations is our range of counterbalanced height adjustable desktop Workstations. Available as a single and dual monitor solution this will reduce the strain on

your shoulders, neck, and eyes when properly positioned. A great solution for flexible and comfortable working year around. Easily placed onto any desktop it adds a worksurface that stays with you as you sit or stand. With a click you simultaneously lift your keyboard and LCD screens to proper height, with another click you can lower it back to the desktop.

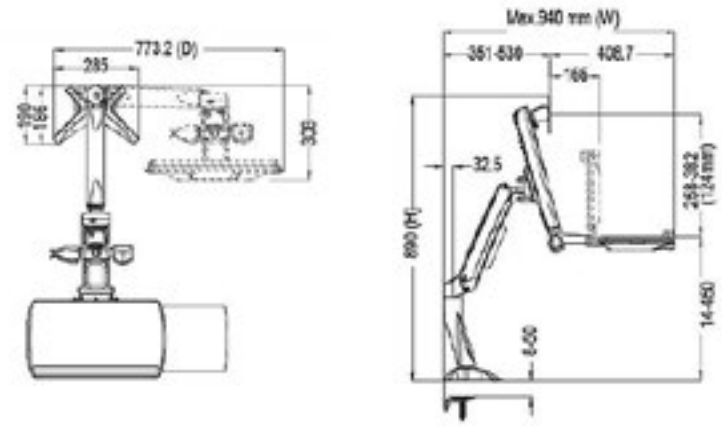

Specification

<b>Model:</b>	<b>M Flex Desk Workstation</b>
<b>Article No:</b>	7 350 073 734 634
<b>Colour:</b>	Black
<b>For screen size:</b>	15-27" (with rotated screen max 24")
<b>Universal &amp; VESA standard:</b>	75x75 100x100 mm M4
<b>Material</b>	Steel, Aluminum, Plastic
<b>Weight</b>	11.4 kg
<b>Size:</b>	940 x 890 x 773 mm
<b>Max load display:</b>	2-8kg
<b>Max load keyboard:</b>	2.5kg
<b>Keyboard area:</b>	449 x 207 mm
<b>Keyboard tilt:</b>	0 ~ 90°
<b>Hinge tilt:</b>	--5° ~ +35°
<b>Hinge swivel:</b>	+/-90°
<b>Hinge pivot:</b>	360°
<b>Height adjust:</b>	124mm / 436 mm
<b>Torque adjust:</b>	Yes
<b>Tilt arm adjust:</b>	- 30° ~ + 65°
<b>Cable Management:</b>	Yes
<b>Installation:</b>	Desk mount
<b>Warranty:</b>	2 years

**Model:** M Workstation Arm Single

**Article No:** 7 350 073 734 351

**Colour:** White

**For screen size:** 15-27" (with rotated screen max 24")

**Universal & VESA standard:** 75x75 100x100 mm M4

**Material:** Steel, Aluminum, Plastic

**Weight:** 9.3 kg

**Size:** 956 x 926 x 333 mm

**Max load display:** 2-8kg

**Max load keyboard:** 2.5kg

**Keyboard area:** 449 x 207 mm

**Keyboard tilt:** 0 ~ 90°

**Hinge tilt:** -5° ~ +35°

**Hinge swivel:** +/-90°

**Hinge pivot:** 360°

**Height adjust:** 124mm

**Torque adjust:** Yes

**Tilt arm adjust:** - 30° ~ + 65°

**Cable Management:** Yes

**Installation:** Wall mount

**Warranty:** 2 years



# M Workstation Arm Single

The M Workstation Arm is made of high grade aluminum and its Scandinavian design heritage can clearly be noticed. Made to free up space and allowing positioning of your display and keyboard for great productivity as well not being in the way when not needed.

## M Workstation Arm Single - Technical Drawing

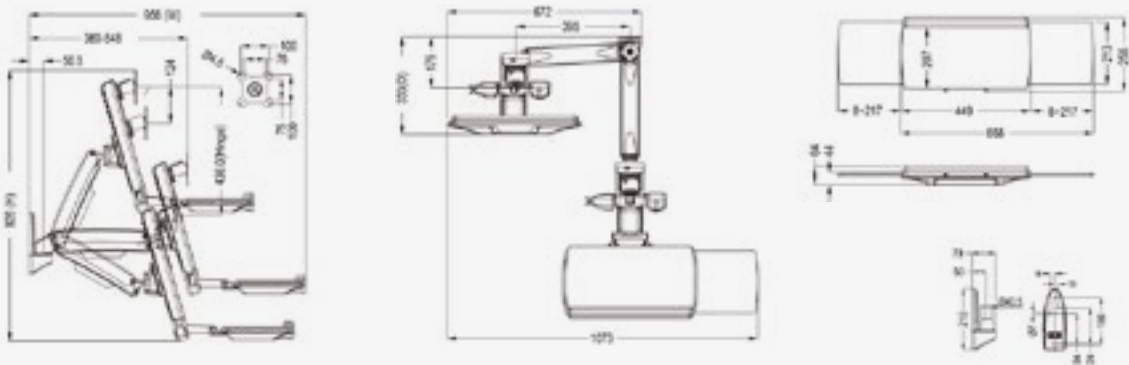

<b>Model:</b>	<b>M Workstation Arm</b> <b>Single Extended</b>
<b>Article No:</b>	7 350 073 734 368
<b>Colour:</b>	White
<b>For screen size:</b>	15-27" (with rotated screen max 24")
<b>Universal &amp; VESA standard:</b>	75x75 100x100 mm M4
<b>Material</b>	Steel, Aluminum, Plastic
<b>Weight</b>	11.4 kg
<b>Size:</b>	1346 x 925.3 x 322 mm
<b>Max load display:</b>	2-8kg
<b>Max load keyboard:</b>	2.5kg
<b>Keyboard area:</b>	449 x 207 mm
<b>Keyboard tilt:</b>	0 ~ 90°
<b>Hinge tilt:</b>	-5° ~ +35°
<b>Hinge swivel:</b>	+/-90°
<b>Hinge pivot:</b>	360°
<b>Height adjust:</b>	124mm
<b>Torque adjust:</b>	Yes
<b>Tilt arm adjust:</b>	- 30° ~ + 65°
<b>Cable Management:</b>	Yes
<b>Installation:</b>	Wall mount
<b>Warranty:</b>	2 years



## M Workstation Arm Single Extended

The M Workstation Arm is made of high grade aluminum and its Scandinavian design heritage can clearly be noticed. Made to free up space and allowing positioning of your display and keyboard for great productivity as well not being in the way when not needed.

M Workstation Arm Extended - Technical Drawing

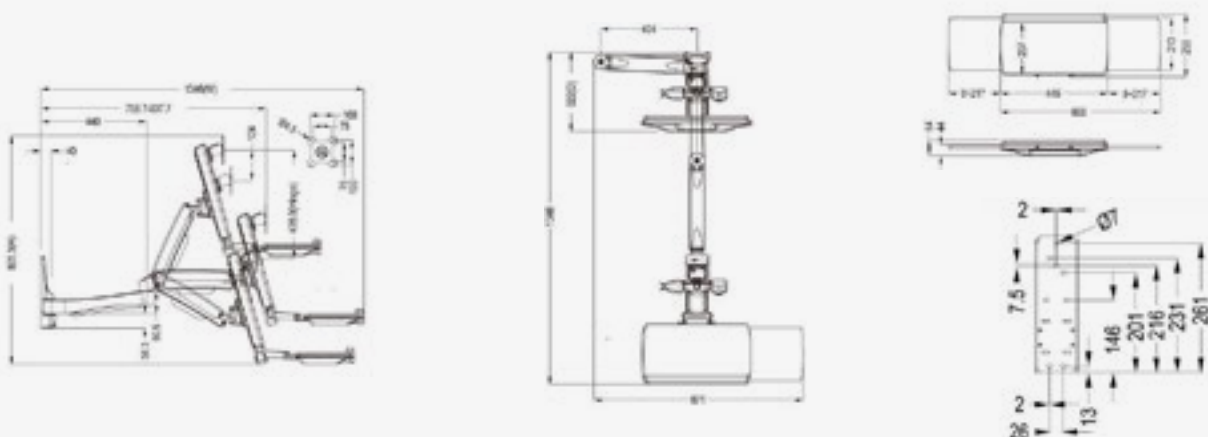



M Deskstand Workstation II

Usable in environments where monitor flexibility & presentations shared with colleagues is of essence



M Deskstand Workstation I

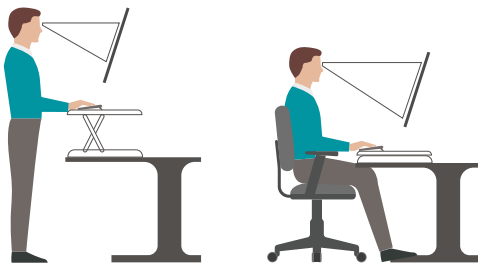

Combined sitting and standing position

M Deskstand Workstation - Specification

	M Deskstand Workstation I	M Deskstand Workstation II
<b>Model:</b>	M Deskstand Workstation I	M Deskstand Workstation II
<b>Article No:</b>	7 350 073 734 337	7 350 073 734 344
<b>For screen size:</b>	15"-27"	15"-27"
<b>Type:</b>	Sit and Stand Table	Sit and Stand Table
<b>Universal &amp; VESA standard:</b>	100x100 to 600x400 max	100x100 to 600x400 max
<b>Material:</b>	Steel, Wood, Plastic	Steel, Wood, Plastic
<b>Color:</b>	Black	Black
<b>Surface Finish:</b>	Plastic Black	Plastic Black
<b>Weight:</b>	24.3 kg	24.3 kg
<b>Measurements:</b>	915 x 607 x 485 mm	915 x 607 x 485 mm
<b>Max Load:</b>	2 kg ~15 kg	2 kg ~15 kg
<b>Height folded:</b>	115mm	115mm
<b>Height adjustment:</b>	370mm	370mm
<b>Height adjustment range:</b>	115mm ~ 485 mm	115mm ~ 485 mm
<b>Max.Working Space:</b>	915 x 600mm	915 x 600mm
<b>Keyboard tray:</b>	No	Yes, 525 x 190mm
<b>Options recommended:</b>	Deskmount arm	Deskmount arm
<b>Certifications:</b>	CE	CE
<b>Warranty:</b>	5 years	5 years



M Easy Stand Desktop Black

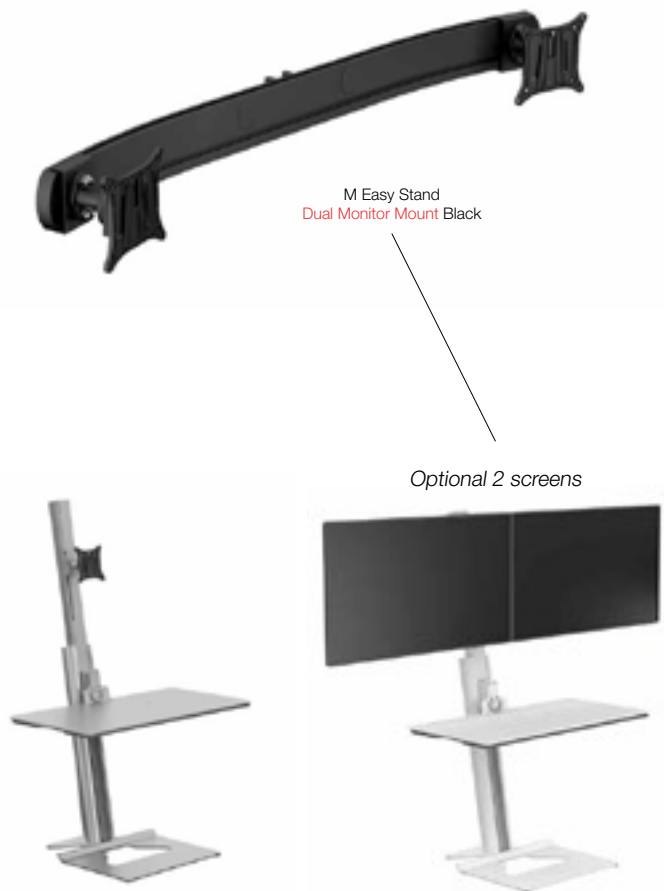

M Easy Stand Desktop Silver

M Easy Stand Desktop White

**M Easy Stand Desktop - Specification**

Model:	M Easy Stand Desktop Black	M Easy Stand Desktop White	M Easy Stand Desktop Silver	M Easy Stand Dual Monitor Mount Black
Article No:	7 350 073 733 156	7 350 073 733 170	7 350 073 733 163	7 350 073 733 187
Colour:	Black	White	Silver	Black
Material:	Aluminum	Aluminum	Aluminum	Aluminum
For screen size:	< 30"	< 30"	< 30"	< 30"
Screen weight:	1.5 - 7.5 kg	1.5 - 7.5 kg	1.5 - 7.5 kg	1 - 3 kg / monitor
VESA standard:	75x75 100x100	75x75 100x100	75x75 100x100	75x75 100x100
Screen adjustment:	140 mm	140 mm	140 mm	140 mm
Height adjustment:	460 mm	460 mm	460 mm	460 mm
Screen tilt:	Yes, ± 25°	Yes, ± 25°	Yes, ± 25°	Yes, ± 25°
Screen rotate:	Yes, 360°	Yes, 360°	Yes, 360°	Yes, 360°
Table size:	640x360 mm (WxD)	640x360 mm (WxD)	640x360 mm (WxD)	640x360 mm (WxD)
Table weight:	0-10 kg	0-10 kg	0-10 kg	0-10 kg
Weight:	13.6 kg	13.6 kg	13.6 kg	15.5 kg
Max load:	7.5 kg	7.5 kg	7.5 kg	3 kg / monitor
Warranty:	5 years	5 years	5 years	5 years

# Headset Holders

Often imitated, never duplicated.

## HIGHLIGHTS:

- Uniquely designed and handmade.
- The original universal Headphones stand.
- Made out of one piece solid material.
- Makes your office desk stand out.

Brass, copper, stainless steel. A headset stand in solid metal, heavy weight.

Looking for a premium level headset stand for your over ear headphones? Our headset stands have become a classic. Often copied and imitated but never duplicated, today the Standard, 'how an exclusive headset stands should look'. So, keep your on ear headphones secure and above all, neat, hanging freely in the air they are unstressed, ensuring a long lasting, good fit, and all whilst being displayed as if in a boutique store.

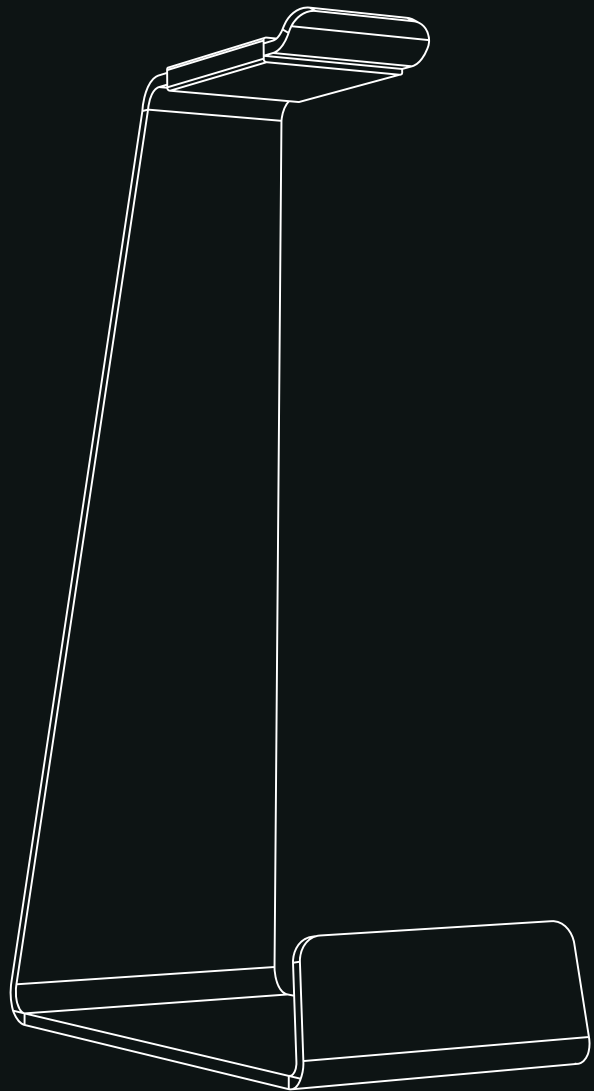



Making you and your  
officedesk stand out



Table



M Headset Holders - TABLE STAND - Specification

Model:	M Headset Holder Table Stand Black	M Headset Holder Table Stand Silver	M Headset Holder Table Stand White	M Headset Holder Table Stand Brass	M Headset Holder Table Stand Copper	M Headset Holder Table Stand Stainless Steel
Article No:	7 350 073 731 893	7 350 073 732 050	7 350 073 731 862	7 350 073 732 845	7 350 073 732 852	7 350 073 734 610
Product measurements:	253x148x80mm	253x148x80mm	253x148x80mm	253x148x80mm	253x148x80mm	253x148x80mm
Weight:	272 g	272 g	272 g	272 g	272 g	272 g
Colour:	Black	Silver	White	Brass	Copper	Stainless Steel
Max load:	1 kg	1 kg	1 kg	1 kg	1 kg	1 kg
Gift box measurements:	260x150x80mm	260x150x80mm	260x150x80mm	260x150x80mm	260x150x80mm	260x150x80mm
Warranty:	5 years	5 years	5 years	5 years	5 years	5 years

## Desk



Black



Silver



White

## Wall



Brass



Copper



Stainless Steel

## M Headset Holders - DESK / WALL - Specification

Model:	M Headset Holder Desk <b>Black</b>	M Headset Holder Desk <b>Silver</b>	M Headset Holder Desk <b>White</b>	M Headset Holder Wall <b>Black</b>	M Headset Holder Wall <b>Silver</b>	M Headset Holder Wall <b>White</b>
<b>Article No:</b>	7 350 073 731 886	7 350 073 732 043	7 350 073 731 855	7 350 073 731 879	7 350 073 732 036	7 350 073 731 848
<b>Product measurements:</b>	112x56x40mm	112x56x40mm	112x56x40mm	112x56x40mm	112x56x40mm	112x56x40mm
<b>Weight:</b>	52 g	52 g	52 g	37 g	37 g	37 g
<b>Colour:</b>	Black	Silver	White	Black	Silver	White
<b>Max load:</b>	1 kg	1 kg	1 kg	1 kg	1 kg	1 kg
<b>Gift box measurements:</b>	120x60x45mm	120x60x45mm	120x60x45mm	120x60x45mm	120x60x45mm	120x60x45mm
<b>Warranty:</b>	5 years	5 years	5 years	5 years	5 years	5 years

# Cable Socks

Versatile, with flexible properties Cable Socks gives abrasion resistance for delicate cables

## HIGHLIGHTS:

- Expands easily to ensure complete coverage and protection.
- Offers general protection from abrasion, chemicals and temperature for optimal protection.
- Available in various sizes and colors.
- Designed to adjust and expand to irregular shapes.
- Keeps its flexibility under a wide range of temperatures and over time.
- Constructed from tightly woven polyester material.
- Provides easy installation on already existing applications simply unwrap the cable sock and apply directly to your cable or product.
- Highly versatile with flexible properties, excellent for office/commercial/ industrial uses.



What's special about Cable Socks, and why would they be needed? Leaving delicate cables exposed to the outside elements puts them at risk of costly abrasive damage and UV degradation. Adding Multibrackets cable sock solutions to cables in high traffic or high friction areas will help extend cable

life and save you money down the road. Unlike traditional braided sleeving or wire loom, these cable socks install easily with no special tools or endless sliding. Our unique colour options also allow colour coding and easy identification of cable infrastructure. A good choice for AV cables, computer cables

(inside and out), server halls, data-centres optical cables (5mm version), hospitals, hotel rooms and anywhere else one might need high quality cable socks. Our Cable Socks are also fire retardant.



Protecting and grouping of wires after installation  
*To be used - everywhere!*





<b>Model:</b>	5mm Yellow	10mm Yellow	19mm Yellow	25mm Yellow	40mm Yellow
<b>Article No:</b>	7 350 073 734 382	7 350 073 734 429	7 350 073 734 467	7 350 073 734 504	7 350 073 734 542
<b>Colour:</b>	Yellow	Yellow	Yellow	Yellow	Yellow
<b>Diameter:</b>	Min: 5mm - Max: 9mm	Min: 10mm - Max: 14mm	Min: 19mm - Max: 30mm	Min: 25mm - Max: 35mm	Min: 40mm - Max: 50mm



<b>Model:</b>	5mm Orange	10mm Orange	19mm Orange	25mm Orange	40mm Orange
<b>Article No:</b>	7 350 073 734 399	7 350 073 734 436	7 350 073 734 474	7 350 073 734 511	7 350 073 734 559
<b>Colour:</b>	Orange	Orange	Orange	Orange	Orange
<b>Diameter:</b>	Min: 5mm - Max: 9mm	Min: 10mm - Max: 14mm	Min: 19mm - Max: 30mm	Min: 25mm - Max: 35mm	Min: 40mm - Max: 50mm



<b>Model:</b>	5mm Red	10mm Red	19mm Red	25mm Red	40mm Red
<b>Article No:</b>	7 350 073 734 412	7 350 073 734 450	7 350 073 734 498	7 350 073 734 535	7 350 073 734 573
<b>Colour:</b>	Red	Red	Red	Red	Red
<b>Diameter:</b>	Min: 5mm - Max: 9mm	Min: 10mm - Max: 14mm	Min: 19mm - Max: 30mm	Min: 25mm - Max: 35mm	Min: 40mm - Max: 50mm



<b>Model:</b>	5mm Blue	10mm Blue	19mm Blue	25mm Blue	40mm Blue
<b>Article No:</b>	7 350 073 734 405	7 350 073 734 443	7 350 073 734 481	7 350 073 734 528	7 350 073 734 566
<b>Colour:</b>	Blue	Blue	Blue	Blue	Blue
<b>Diameter:</b>	Min: 5mm - Max: 9mm	Min: 10mm - Max: 14mm	Min: 19mm - Max: 30mm	Min: 25mm - Max: 35mm	Min: 40mm - Max: 50mm



<b>Model:</b>	5mm White	10mm White	19mm White	25mm White	40mm White
<b>Article No:</b>	7 350 073 733 194	7 350 073 733 224	7 350 022 734 203	7 350 073 732 777	7 350 073 732 807
<b>Colour:</b>	White	White	White	White	White
<b>Diameter:</b>	Min: 5mm - Max: 9mm	Min: 10mm - Max: 14mm	Min: 19mm - Max: 30mm	Min: 25mm - Max: 35mm	Min: 40mm - Max: 50mm



<b>Model:</b>	5mm Silver	10mm Silver	19mm Silver	25mm Silver	40mm Silver
<b>Article No:</b>	7 350 073 733 200	7 350 073 733 231	7 350 022 734 180	7 350 073 732 784	7 350 073 732 814
<b>Colour:</b>	Silver	Silver	Silver	Silver	Silver
<b>Diameter:</b>	Min: 5mm - Max: 9mm	Min: 10mm - Max: 14mm	Min: 19mm - Max: 30mm	Min: 25mm - Max: 35mm	Min: 40mm - Max: 50mm



<b>Model:</b>	5mm Black	10mm Black	19mm Black	25mm Black	40mm Black
<b>Article No:</b>	7 350 073 733 217	7 350 073 733 248	7 350 022 734 197	7 350 073 732 791	7 350 073 732 821
<b>Colour:</b>	Black	Black	Black	Black	Black
<b>Diameter:</b>	Min: 5mm - Max: 9mm	Min: 10mm - Max: 14mm	Min: 19mm - Max: 30mm	Min: 25mm - Max: 35mm	Min: 40mm - Max: 50mm

**Accessories**



<b>Model:</b>	M Cable Sock Heat Cutter	M Cable Sock Quicktool
<b>Article No:</b>	7 350 022 732 926	7 350 073 734 689
<b>Colour:</b>	Light Blue	Blue
<b>Warranty:</b>	1 year	1 year

**M Universal Cable Socks Self Wrapping - Specification**

<b>Material:</b>	Polyester
<b>Self wrapping:</b>	Yes
<b>Sock length:</b>	25 m
<b>Working temp. :</b>	-50°C+ 150°C
<b>Melting point:</b>	240±10°C
<b>Flammability:</b>	8s6853 lb UL94 V-0 FMVSS 302
<b>Monofilament diameter:</b>	0,25mm
<b>Safety:</b>	Fire retardant material
<b>Certificate:</b>	RoHS
<b>Warranty:</b>	5 years
<b>Weight:</b>	Depending on size

**Wear-resisting level:**  
ISO6722, Load 7N, Number of scratches ≥3000 times, high wear resistance.

**Application:**  
It is widely used in electrical wiring, cables, wiring harness and hoses for high-speed trains, cars, automation equipment, instruments, and especially for irregularly wiring harness.

# M LAPTOP WORKSTATION SIT AND STAND WHEN WORKING FROM HOME

Own your space, move up and down while infusing your workdays with movement and ergonomics.

Introducing an easy stand desk solution for everyone at work or at home. Now you can convert any open space into a Deskstand Workstation in a matter of seconds. Lets start enable easy height adjustment and great ergonomics with effortless touch, at home. Once you started to use this you will never go back to an old desk again, trust us - this way of work will be addictive!

This height-adjustable sit and standing desk moves quietly straight up and down as you go from sit to stand. Take your worksurface, Notebook and pivot to new heights in seconds.

This ingenious product converts any open surface to a workspace. Simply hold the handle on the side of the desk and move your M Laptop Workstation to a standing or sitting position. The worksurface holds your notebook and is ultra flexible to use with your most common accessories.



## M Laptop Workstation White / Black

**Article No:** 7350073739141 - White  
7350073739127 - Black

**Height adjustment:** 60-420mm

**Table size:** 580x320 mm

**Material:** Steel, Aluminum, Plastic

**Surface Finish:** Powder Coating

**Colour:** White / Black

**Max load:** 2~10kg

**Function:** Gas driven piston

**Tilt angle:** :+0°~-30°

**Installation:** Freestanding

**Measurements:** 580x420x170mm

**Weight:** 7.2 kg

**Warranty:** 2 years

## SIT & STAND

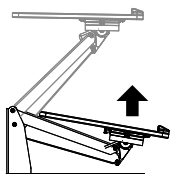

Improve your posture  
Switch between standing  
and sitting position



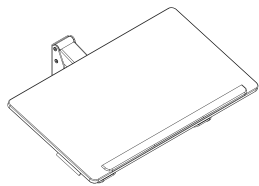

**Small & compact**  
Designed to fit small tables and work spaces

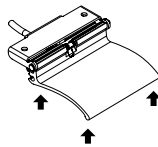

**Quick elevation**  
Adjust the release handle to elevate the table quickly

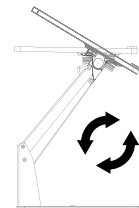

**Tiltable table**  
Easily tilt your laptop for better viewing

## HIGHLIGHTS

- Improve your productivity by switching between sitting and standing position whilst at work
- Save your back long term as you can choose to stand up or sit down
- Provides ample of smooth vertical height adjustment
- User-friendly torque adjust holds the display weight and the rest of your work area in position with ease
- Designed for ultimate productivity in areas where less surface is available

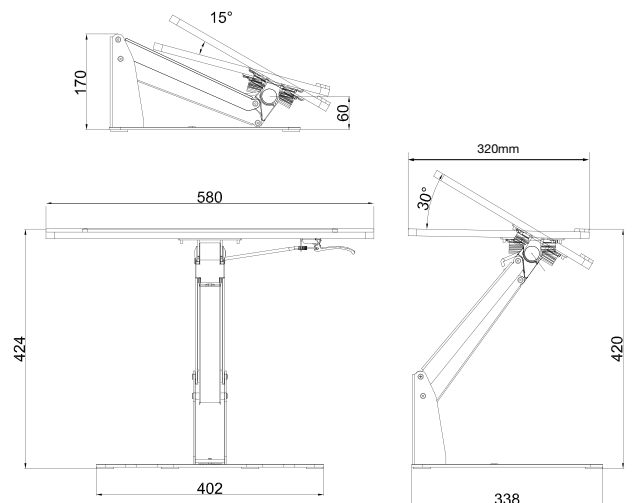

# M DESKMOUNT SLIM BASIC SINGLE A HIGH-EFFICIENCY WORKSPACE SOLUTION

Free up occupied desk space through a unique design that provides easier maneuverability and capable of moving even to fit flush against a wall.

Perfect for 17" up to some 32" monitors, this monitor arm offers height as well as screen angle adjustments for your optimal viewing and ergonomic posture. With a maximum weight capacity of 8kg, it can be easily mounted on most desktop surfaces with a clamp-on design that reduces installation time.

If your workspace isn't too big, Multibrackets new minimal monitor mount M Deskmount Slim Basic Single could help by freeing you up some space. The newly unveiled M Deskmount Slim Basic Single, a screen that clamps onto your desk and according to the company can increase your desk space by up to 40 percent. Flexible, sleek and streamlined, the M Deskmount Slim Basic Single frees up space and allows positioning of your display for greater productivity.

## SPACE SAVER

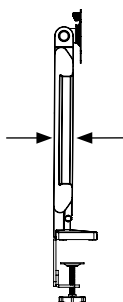

Save 40% desk space!  
Designed to fit small  
tables and work spaces



### M Deskmount Slim Basic Single

<b>For screen size:</b>	17"-32"
<b>Feature:</b>	Space saver
<b>VESA standard:</b>	75x75,100x100
<b>Article No:</b>	735007373 9974
<b>Size in mm: (H*W*D)</b>	114 x 92 x 615mm
<b>Fits Curved Screens?</b>	Yes
<b>Tilt:</b>	Yes, approx. -5 to 90 degrees
<b>Swivel:</b>	N/A
<b>Rotation of TV plate:</b>	Yes, approx. -180°~+180° degrees
<b>Cable Management:</b>	Yes
<b>Weight:</b>	3.22 kg (weight of one packed unit)
<b>Colour:</b>	Black
<b>Max load:</b>	2-8 kg
<b>Distribution package:</b>	6 pcs
<b>Warranty:</b>	5 years

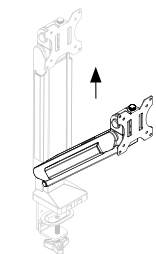

**Adjust height**  
Adjust the height of the screen

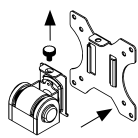

**Detachable VESA**  
Detachable VESA plate makes installation easy

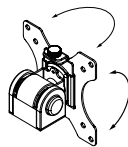

**Tilt & swivel**  
Easily adjust the screen for better view

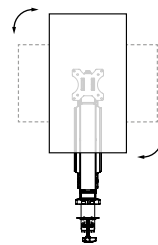

**Portrait & landscape**  
Rotate the screen for a suitable view

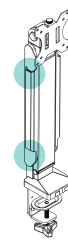

**Cable Management**  
Easily hide your cables in good order

## HIGHLIGHTS

- Space-Saving Design
- Detachable VESA plate makes installation easy
- Built in Cable management
- Adjust height for an optimal ergonomic position

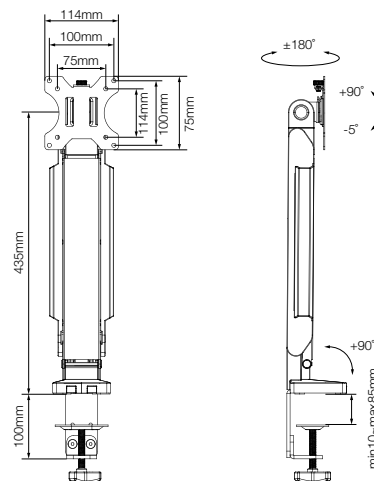

# M DESKMOUNT SLIM BASIC DUAL A HIGH-EFFICIENCY WORKSPACE SOLUTION

If your workspace isn't too big and you still want two displays, you should take a closer look at this product.

A well designed high efficiency workspace solution. This product aims at freeing up occupied desk space through a unique design that provides easier maneuverability and capable of moving even to fit flush against a wall. Perfect for displays ranging between 17" and 27" in size, this monitor arm offers height as well as screen angle adjustments for your optimal viewing and ergonomic posture. With a maximum weight capacity of 6.5kg per screen it can be easily mounted on most desktop surfaces with a clamp-on design that reduces installation time.

If your workspace isn't too big and you still want two displays, you should take a closer look at this product.



## M Deskmount Slim Basic Single

<b>For screen size:</b>	17"-32"
<b>Feature:</b>	Space saver
<b>VESA standard:</b>	75x75,100x100
<b>Article No:</b>	735007373 9981
<b>Size in mm: (H*W*D)</b>	717 x 128 x 628mm
<b>Fits Curved Screens?</b>	Yes
<b>Tilt:</b>	Yes, approx. -20° to 45° degrees
<b>Swivel:</b>	15°~ -15° degrees
<b>Rotation of TV plate:</b>	Yes, approx. -180°~+180° degrees
<b>Cable Management:</b>	Yes
<b>Weight:</b>	5.56kg ( weight of one packed unit)
<b>Colour:</b>	Black
<b>Max load (per screen):</b>	2~6.5kg
<b>Warranty:</b>	5 years

# SPACE SAVER

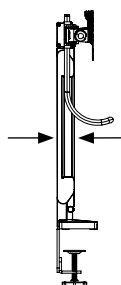

Save 40% desk space!  
Designed to fit small tables and work spaces

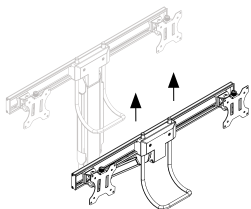

**Adjust height**  
Easily adapt the height of the screen

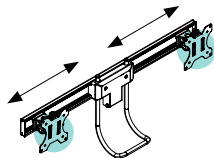

**Lateral Shift**  
Slide each monitor horizontally with ease

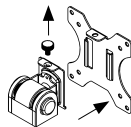

**Detachable VESA**  
Detachable VESA plate makes installation easy

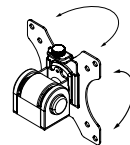

**Tilt & swivel**  
Easily tilt your screen for better viewing

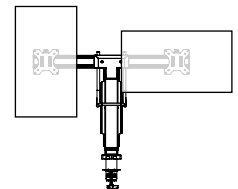

**Portrait & landscape**  
Rotate the screen for a suitable view

## HIGHLIGHTS

- Dual display space-saving design
- Built in handle for easy grip & reposition both screens at once
- Detachable VESA plates makes installation easy
- Lateral shift possible
- Built in Cable management
- Adjust height for an optimal ergonomic position

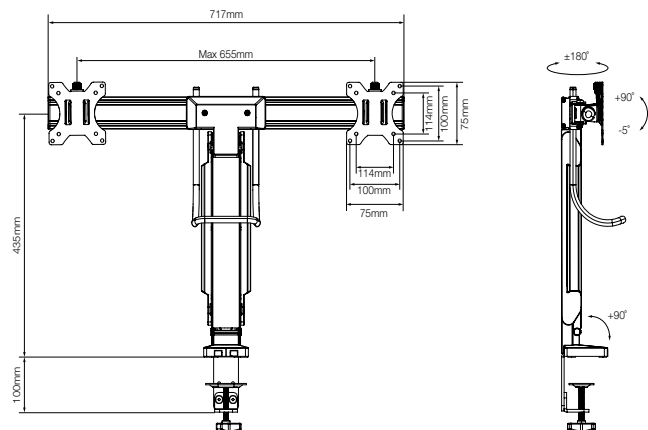

# M DESKMOUNT XL

## THE NEW BIG SIZE LIFESTYLE MONITORS WORKS AS TV AND DISPLAY IN ONE! UP TO 55"

Versatile and affordable 'do-it-all' screen offers flexibility for work, learning and entertainment at home.

This is a height adjustable tabletop mount for large size displays with an ultra slim design. With the increasing demand for large size displays and video conference equipment and more focus on collaborative working, we introduced the M Deskmount XL Black.

Easily Mount 32"-55" Monitors or TVs to a Multimedia Table for Use in Conferences, Displays or Presentations. With support of interactive displays, and other large size displays, our mounts can attach quickly to most any surface and support for video conferences or training, group discussions or presentations in offices, especially in huddle rooms. Rear back hides hardware for a clean look.



## SPACE SAVER

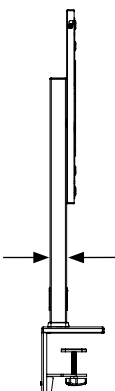

Ultra slim  
Designed to fit small  
tables and work spaces

### M Deskmount XL White / Black

**Article No:** 7350105210129 - Black  
7350105210136 - White

**Colour:** Black / White

**For screen size:** 32" - 55"

**VESA standard:** 75x75, 100x100, 200x200, 300x300, 400x400

**Max load:** 35 kg

**Height adjustment:** Yes. 440/490/540mm

**Cable Management:** Yes

**Size in mm: (H\*W\*D)** 460 x 150 x 924 mm

**Weight:** 8.1

**Warranty:** 5 years

**Dual Use  
TV & Monitor**

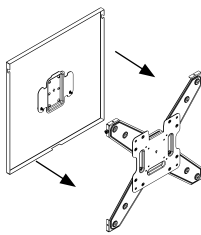

**Detachable VESA**  
Detachable VESA plate makes installation easy

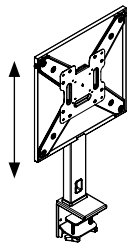

**Height adjustment**  
Height can be adjusted to three different stages

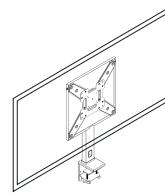

**Extra Large Screens**  
Handles large size screens & displays

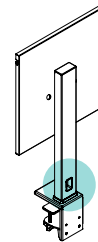

**Cable Management**  
Easily hide your cables in good order

**HIGHLIGHTS**

- Handles large size displays 32" - 55"
- Ultra slim and space saving
- Three stage height adjustment
- Built in cable management
- Detachable VESA plate
- Elegantly designed back coverplate

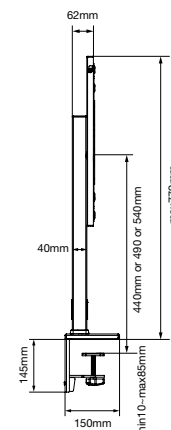
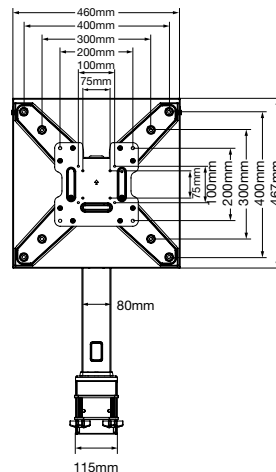

# M VESA GAS LIFT ARM SINGLE

## UNIQUE GAS TECHNOLOGY THAT PROVIDES SMOOTH ADJUSTMENT IN ANY DIRECTION

A triple jointed gas suspended monitor arm, designed by Multibrackets to optimize your productivity and help reducing strain on neck, back and eyes.

These Full Motion Universal Desk Mounts goes beyond simple movements by offering tool less movement and counter balance weight adjustment. The original M VESA Gas Lift Arms are made out of a durable aluminum construction and uses a gas driven suspension technique. Always finding your best view, saving desk space and letting you discover your most productive self, the M VESA Gas Lift Monitor Arms always deliver.

Place your screen where you need it for each project, and then reclaim a space full of opportunities by folding the arm and pushing it aside during a much needed screen break.

Wide

27"-32"

16:9

27"-37"

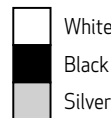

White  
Black  
Silver



Gas Lift cylinder

### M VESA Gas lift Arm Single

**Article No:** 7350022737174 - Black  
7350022737167 - Silver  
7350022737150 - White

**For screen size:** 15-32"

**VESA standard:** 75x75, 100x100mm

**Colour:** Black / silver / white

**Screen weight:** Min. 2 kg - Max. 10 kg

**Function:** Gas driven piston

**Rotate:** 90°

**Weight:** 3.4 kg

**Tilt angle:** +75° to -45°

**Turn angle:** +90° to -90°

**Warranty:** 2 years



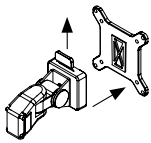

Detachable VESA  
For easy installation

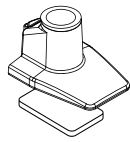

Desk clamp  
(included)

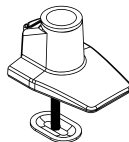

Grommet  
(included)

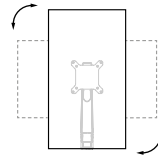

Portrait & landscape  
For a suitable view

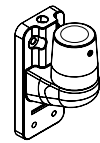

Wall Adapter  
(optional)

## HIGHLIGHTS

- Move your display to a perfect position, improve your daily use and ergonomics
- This arm easily adjusts monitors up to 32" in size
- Clear your desk and enlarge your working area
- We designed this with both mechanics and aesthetics in mind
- Connects your screen to the arm with a snap
- This gas arm is built to last longer than our competitors by passing our 10 000 cycle motion test

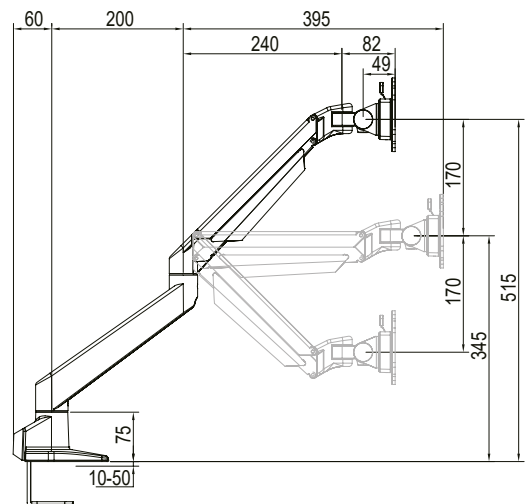

# M VESA GAS LIFT ARM SINGLE XL HD MAKING YOUR WIDESCREEN FLOAT LIKE A FEATHER

Frees up space and allows positioning of your extra large screen for greater productivity.

These Full Motion Universal Desk Mounts goes beyond simple movements by offering tool less movement and counter balance weight adjustment. The original M VESA Gas Lift Arms are made out of a durable aluminum construction and uses a gas driven suspension technique.

Always finding your best view, saving desk space and letting you discover your most productive self, the M VESA Gas Lift Monitor Arms always deliver. Place your screen where you need it for each project, and then reclaim a space full of opportunities by folding the arm and pushing it aside during a much needed screen break.

Wide

**27" - 37"**

16:9

**15" - 55"**

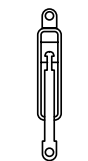
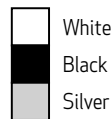

Gas Lift cylinder

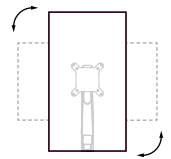

Portrait & landscape  
For a suitable view

## M VESA Gas lift Arm Single XL HD

**Article No:** 7350073737123 - Black  
7350073737130 - Silver  
7350073737147 - White

**For screen size:** 15"-49"

**VESA standard:** 75x75, 100x100, 200x200mm

**Colour:** Black / white / silver

**Screen weight:** Min. 9 kg - Max. 18 kg

**Function:** Gas driven piston

**Rotate:** 90°

**Weight:** 4,4 kg

**Tilt angle:** +75° to -45°

**Turn angle:** +90° to -90°

**Warranty:** 2 years

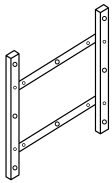

VESA 200x100 & 200x200  
For extra large screens

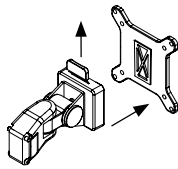

Detachable VESA  
Makes installation easy

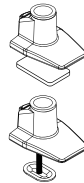

Desk clamp & grommet  
(included)

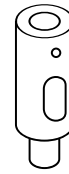

Extension pipe  
(included)

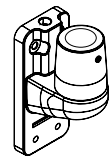

Wall Adapter  
(optional)

## HIGHLIGHTS

- Move your display to a perfect position, improve your daily use and ergonomics
- This arm easily adjusts monitors up to 32" in size
- Clear your desk and enlarge your working area
- We designed this with both mechanics and aesthetics in mind
- Connects your screen to the arm with a snap
- This gas arm is built to last longer than our competitors by passing our 10 000 cycle motion test

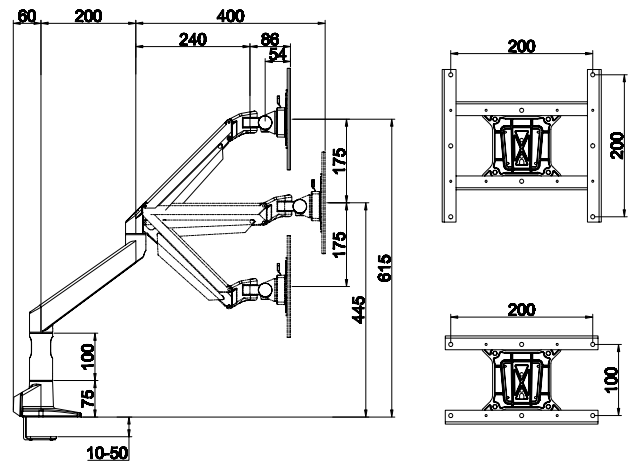

# M VESA DESKMOUNT HD DUAL VERTICAL WIDE 32"-50" STACKING DESKTOP MONITORS INCREASES EFFICIENCY & SAVES SPACE

While desk widths at home often are scarce, ceilings are (so far) staying put. So while you may not have the room to put two or three displays side by side at home, there's almost always ample room to go up, into what is otherwise unused space.

With the new large size widescreen curved monitors hitting the market Multibrackets mounting systems can handle stacked displays as large as twin 50 inch. curved monitors, creating a vast, immersive working canvas.

This is a height adjustable tabletop mount for large size displays with an ultra slim design. With the increasing demand for large size displays and video conference equipment and more focus on collaborative working, we introduced the M Deskmount XL Black.

Easily Mount 37"-55" Monitors or TVs to a Multimedia Table for Use in Conferences, Displays or Presentations. With support of interactive displays and other large size displays our mounts can attach quickly to most any surface and support for video conferences or training, group discussions or presentations in offices, especially in huddle rooms. Rear back hides hardware for a clean look.



## M VESA Deskmount Dual Vertical Wide 32"-50"

<b>Article No:</b>	7350105210556	7350105210563	7350105210570
<b>Colour:</b>	Black	Black	Black
<b>Material:</b>	Aluminum / Steel	Aluminum	Aluminum
<b>Weight:</b>	8 kg	0.5 kg	3.1 kg
<b>Measurements:</b>	800x170x190 mm	210x210x40mm	410x395x40mm
<b>Warranty:</b>	5 years	5 years	5 years
<b>For screen size:</b>	32" - 50"		
<b>Tilt:</b>	Yes -15° - +20°		
<b>Swivel:</b>	Yes ±20°		
<b>Rotate:</b>	Yes 360°		
<b>Installation:</b>	Desk clamp, adjustable 10-60 mm		
<b>Univesal VESA standard:</b>	75x75 100x100 mm		
<b>Max load:</b>	24 kg per screen		
<b>Adjustable height upper screen:</b>	560-790 mm		
<b>Adjustable height lower screen:</b>	185-415mm		
<b>Cable Management:</b>	Yes		

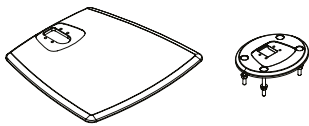
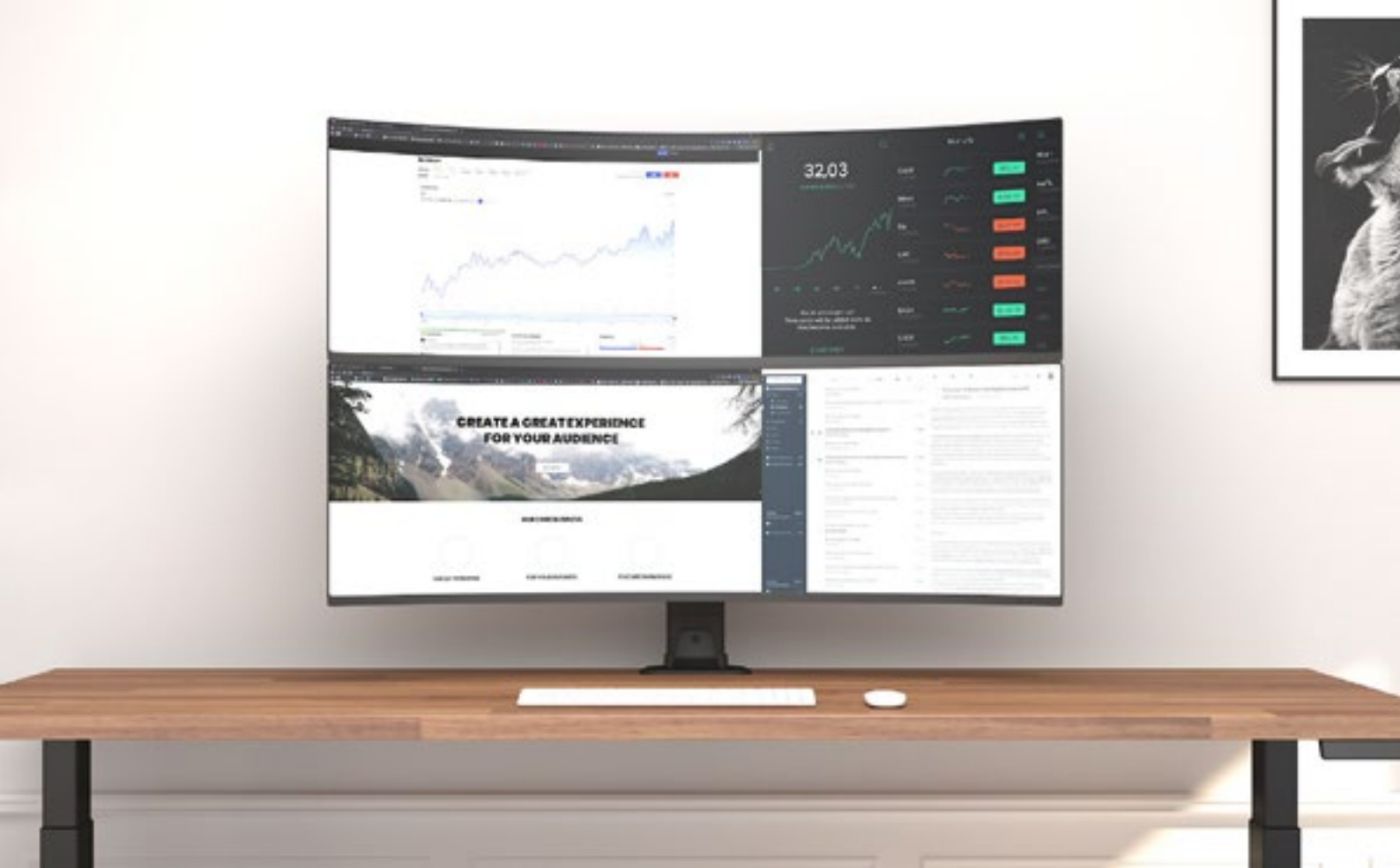

**Exchangeable Base**  
Attach a different base according to your needs

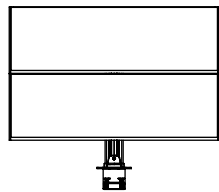

**Large Screens**  
Easily mount two screens on top of each other

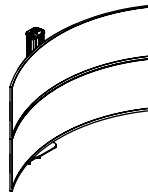

**Curved Screens**  
Specially designed for curved screens

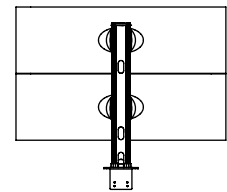

**Cable Management**  
Integrated cable management for clean installation

## HIGHLIGHTS

- A high level designed productline for office use
- Made for the professional user
- Creates maximum ergonomic comfort for displays up to 50"
- Simplified installation and simple after adjustment possibilities
- Plexi based cable management (included)
- Optional through hole installation with Grommet Base



±20° Swivel

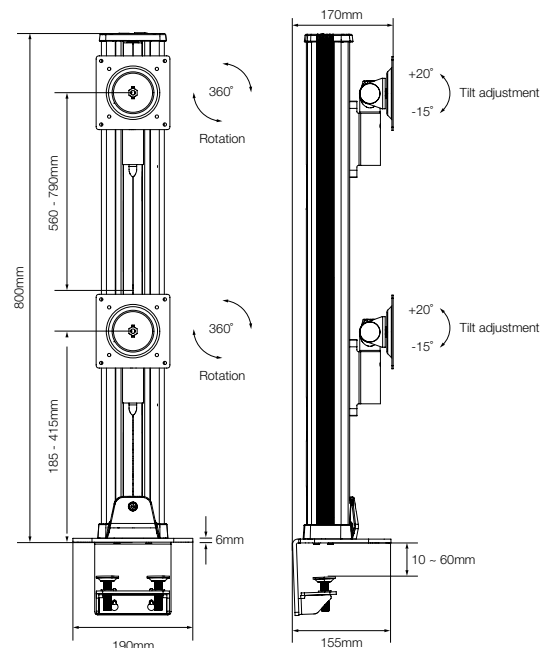

# HEADSET HOLDERS

## MAKING YOU AND YOUR OFFICE DESK STAND OUT!

Brass, copper, stainless steel. A headset stand in solid metal, heavy weight.

Looking for a premium level headset stand for your over ear headphones? Our headset stands have become a classic. Often copied and imitated but never duplicated, today the Standard, 'how an exclusive headset stands should look'. So, keep your on ear headphones secure and above all, neat, hanging freely in the air they are unstressed, ensuring a long lasting, good fit, and all whilst being displayed as if in a boutique store.

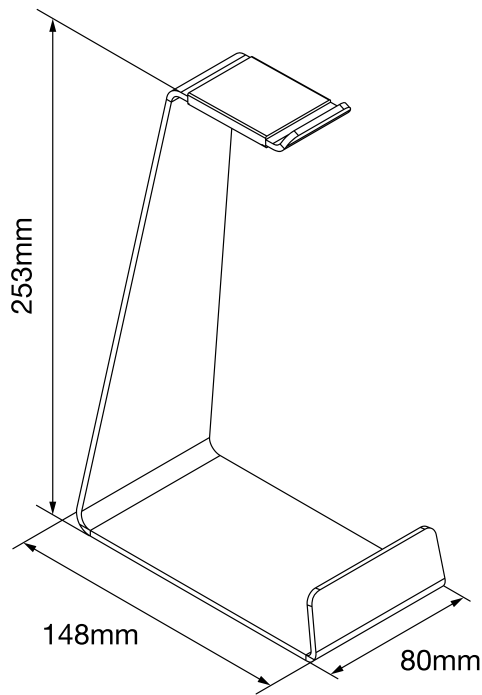

Table Stands



<b>Article No:</b>	7350 073 731 893	7350 073 732 050	7350 073 731 862	7350 073 732 845	7350 073 732 852	7350 073 734 610
<b>Product measurements:</b>	253x148x80mm	253x148x80mm	253x148x80mm	253x148x80mm	253x148x80mm	253x148x80mm
<b>Weight:</b>	272 g	272 g	272 g	272 g	272 g	272 g
<b>Colour:</b>	Black	Silver	White	Brass	Copper	Stainless Steel
<b>Max load:</b>	1 kg	1 kg	1 kg	1 kg	1 kg	1 kg
<b>Gift box measurements:</b>	260x150x80mm	260x150x80mm	260x150x80mm	260x150x80mm	260x150x80mm	260x150x80mm
<b>Warranty:</b>	5 years	5 years	5 years	5 years	5 years	5 years



## HIGHLIGHTS

- Uniquely designed and handmade
- The original universal Headphones stand
- Made out of one piece solid material
- Makes your office desk stand out

Desk



Wall



<b>Article No:</b>	7 350 073 731 886	7 350 073 732 043	7 350 073 731 855	7 350 073 731 879	7 350 073 732 036	7 350 073 731 848
<b>Product measurements:</b>	112x56x40mm	112x56x40mm	112x56x40mm	112x56x40mm	112x56x40mm	112x56x40mm
<b>Weight:</b>	52 g	52 g	52 g	37 g	37 g	37 g
<b>Colour:</b>	Black	Silver	White	Black	Silver	White
<b>Max load:</b>	1 kg	1 kg	1 kg	1 kg	1 kg	1 kg
<b>Gift box measurements:</b>	120x60x45mm	120x60x45mm	120x60x45mm	120x60x45mm	120x60x45mm	120x60x45mm
<b>Warranty:</b>	5 years	5 years	5 years	5 years	5 years	5 years

# CABLE SOCKS ELEGANT RESISTANCE FOR DELICATE CABLES

Versatile, with flexible properties Cable Socks gives abrasion resistance for delicate cables.

Leaving delicate cables exposed to the outside elements puts them at risk of costly abrasive damage and UV degradation. Adding Multibrackets cable sock solutions to cables in high traffic or high friction areas will help extend cable life and save you money down the road. Unlike traditional braided sleeving or wire loom, these cable socks install easily with no special tools or endless sliding. Our unique colour options also allow colour coding and easy identification of cable infrastructure. A good choice for AV cables, computer cables (inside and out), server halls, datacentres optical cables (5mm version), hospitals, hotel rooms and anywhere else one might need high quality cable socks. Our Cable Socks are also fire retardant.

## HIGHLIGHTS

- Expands easily to ensure complete coverage and protection.
- Offers general protection from abrasion, chemicals and temperature for optimal protection.
- Available in various sizes and colors.
- Designed to adjust and expand to irregular shapes.
- Keeps its flexibility under a wide range of temperatures and over time.

## 25m rolls!



### M Universal Cable Socks Self Wrapping

<b>Material:</b>	Polyester
<b>Self wrapping:</b>	Yes
<b>Sock length:</b>	25m
<b>Working temp. :</b>	-50°C-+ 150°C
<b>Melting point:</b>	240±10°C
<b>Flammability:</b>	8s6853 lb UL94 V-0 FMVSS 302
<b>Monofilament diameter:</b>	0.25mm
<b>Safety:</b>	Fire retardant material
<b>Certificate:</b>	RoHS
<b>Warranty:</b>	5 years
<b>Weight:</b>	Depending on size

#### Wear-resisting level:

ISO6722, Load 7N, Number of scratches ≥3000 times, high wear resistance.

#### Application:

It is widely used in electrical wiring, cables, wiring harness and hoses for high-speed trains, cars, automation equipment, instruments, and especially for irregularly wiring harness.

<b>Model:</b>	<b>M Cable Sock Heat Cutter</b>
<b>Article No:</b>	7 350 022 732 926
<b>Colour:</b>	Light Blue
<b>Warranty:</b>	1 year

































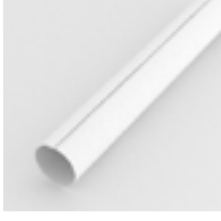

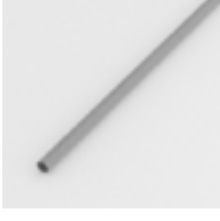

<b>Model:</b>	<b>M Cable Sock Quicktool</b>
<b>Article No:</b>	7 350 073 734 689
<b>Colour:</b>	Blue
<b>Warranty:</b>	1 year



- Constructed from tightly woven polyester material.
- Provides easy installation on already existing applications simply unwrap the cable sock and apply directly to your cable or product.
- Highly versatile with flexible properties, excellent for office/commercial/ industrial uses.



Diameter:	5mm - 9mm	10mm - 14mm	19mm - 30mm	25mm - 35mm	40mm - 50mm
<i>YELLOW</i>	 7350 073 734 382	 7350 073 734 429	 7350 073 734 467	 7350 073 734 504	 7350 073 734 542
<i>ORANGE</i>	 7350 073 734 399	 7350 073 734 436	 7350 073 734 474	 7350 073 734 511	 7350 073 734 559
<i>RED</i>	 7350 073 734 412	 7350 073 734 450	 7350 073 734 498	 7350 073 734 535	 7350 073 734 573
<i>BLUE</i>	 7350 073 734 405	 7350 073 734 443	 7350 073 734 481	 7350 073 734 528	 7350 073 734 566
<i>WHITE</i>	 7350 073 733 194	 7350 073 733 224	 7350 022 734 203	 7350 073 732 777	 7350 073 732 807
<i>GREY</i>	 7350 073 733 200	 7350 073 733 231	 7350 022 734 180	 7350 073 732 784	 7350 073 732 814
<i>BLACK</i>	 7350 073 733 217	 7350 073 733 248	 7350 022 734 197	 7350 073 732 791	 7350 073 732 821

Up to **85"**



**NEW!**

## MVESA FLEXARM XL FULL MOTION DUAL

This uniquely designed low profile MVESA Flexarm XL FullMotionDual mount fits flat panels up to 85" or 45 kgs. Well suited for those applications where seamless integration counts the most offering a slim design without compromising on functionality. Moreover, this flexarm has an extended profile of 500 mm from the wall.

### SPECIFICATION MVESA FLEXARM XL FULL MOTION DUAL

<b>For screen size:</b>	40" - 85"
<b>Tilt:</b>	-5° ~ +8°
<b>Turn:</b>	Up to -60° ~ +60°, screen size dependant.
<b>Leveling adjustment:</b>	+4° / -4°
<b>VESA standard:</b>	200x100, 200x200, 300x300, 300x200, 400x200, 400x400, 600x400.
<b>Article No:</b>	7 350 073 736 317
<b>Size in mm:</b>	640*450*58-500 (W*H*D)
<b>Distance to wall:</b>	58 - 500 mm
<b>Weight:</b>	8 kg
<b>Colour:</b>	Black
<b>Max load:</b>	45 kg
<b>Warranty:</b>	5 years

Up to **60"**



## MVESA FLEXARM FULL MOTION DUAL

The MVESA Flexarm FullMotionDual is part of the Slim Series of fixed, tilt and cantilever mounts offering a slim design without compromising on functionality. The Flexarm FullMotionDual has an extended profile of 488 mm from the wall.

### SPECIFICATION MVESA FLEXARM FULL MOTION DUAL

<b>For screen size:</b>	40" - 60"
<b>Tilt:</b>	-2° ~ +10°
<b>Turn:</b>	Up to -45° ~ +45°, screen size dependant.
<b>VESA standard:</b>	100x100, 200x100, 200x200, 300x300, 300x200, 400x200, 400x400, 600x400.
<b>Article No:</b>	7 350 073 731 732
<b>Size in mm:</b>	595*294*46-488 (W*H*D)
<b>Distance to wall:</b>	46 mm
<b>Weight:</b>	8 kg
<b>Colour:</b>	Black
<b>Max load:</b>	45 kg
<b>Warranty:</b>	5 years

Up to **50"**



## MVESA FLEXARM FULL MOTION SINGLE

MVESA Flexarm FullMotion Single is suitable for a wide range of screens sized up to 50". The VESA standards that are supported by this mount up to 400 and an extended profile up to 498 mm.

### SPECIFICATION MVESA FLEXARM FULL MOTION SINGLE

<b>For screen size:</b>	32" - 50"
<b>Tilt:</b>	-5° ~ +8°
<b>Turn:</b>	Up to -45° ~ +45°, screen size dependant.
<b>VESA standard:</b>	100x100, 200x100, 200x200, 300x300, 300x200, 400x200, 400x400.
<b>Article No:</b>	7 350 073 731 725
<b>Size in mm:</b>	595*294*46-488 (W*H*D)
<b>Distance to wall:</b>	50 mm
<b>Weight:</b>	8,4 kg
<b>Colour:</b>	Black
<b>Max load:</b>	30 kg
<b>Warranty:</b>	5 years

Technical specifications & other details may change without further notice. All rights reserved Multibrackets 2018.

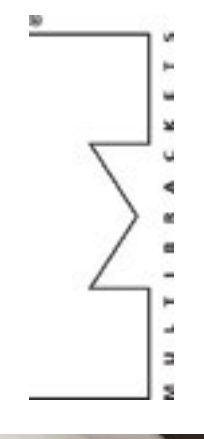

# CABLE COVERS

## MULTIBRACKETS



# Range Details

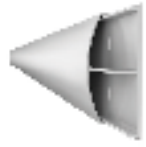

- 1. Super Slim (SS) Cable Covers**  
Aluminum / 4 Colours / 2 Lengths



- 2. Universal Cable Covers**  
Aluminum / 3 Colours / 2 Lengths



- 3. Cable Cover Joints**  
ABS Plastic / For Universal Cable Covers



# Super Slim (SS) Cable Covers

4 colour options:

Aluminium / Brushed / Black / White (Coated)

2 length options:

1100 mm / 1600 mm

High quality aluminium trunking

Screws straight to the wall

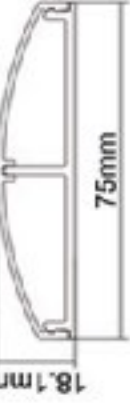

Single gift box packaging delivered in 6-packs

Minimum order quantities apply





# Super Slim (SS) Cable Covers

	Aluminium	Brushed	Black	White	MSRP (excl. VAT)
1100 mm	7350022733831	7350022733848	7350022733855	7350022733862	57 €
1600 mm	7350022733879	N/A	7350022733893	7350022733909	69 €



# Universal Cable Covers

5 size options:

12 mm / 18 mm / 33 mm / 50 mm / 80 mm

3 colour options:

Aluminium / Black / White (Coated)

2 length options:

1100 mm / 1600 mm

High quality aluminium trunking

Screws straight to the wall

Single gift box packaging delivered in 6-packs





# Universal Cable Covers

		Aluminium	Black	White	MSRP (excl. VAT)
1100 mm	12 mm	7350022731158	N/A	N/A	27 €
	18 mm	7350022731219	7350022731226	7350022731233	30 €
	33 mm	7350022731271	7350022731288	7350022731295	39 €
	50 mm	7350022731332	7350022731349	7350022731356	51 €
	80 mm	7350022732131	7350022732148	7350022732155	66 €
1600 mm	12 mm	7350022731189	7350022731196	7350022731202	33 €
	18 mm	7350022731240	7350022731257	7350022731264	42 €
	33 mm	7350022731301	7350022731318	7350022731325	51 €
	50 mm	7350022731363	7350022731370	7350022731387	63 €
	80 mm	N/A	7350022732179	7350022732186	81 €





# Cable Cover Joints

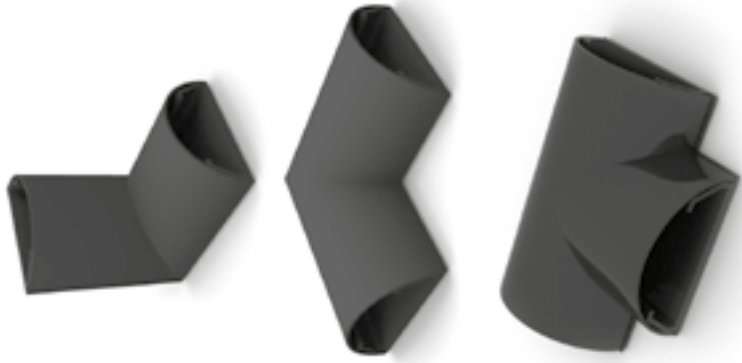

L, C & T-Shaped Joints

2 size options  
(matching Universal Cable Covers):  
33 mm / 50 mm

3 colour options:  
Aluminium / Black / White (Coated)

ABS Plastic

Screws straight to the wall



# Cable Cover Joints

		Aluminium	Black	White	MSRP (excl. VAT)
L & C Joints	50 mm	7350022732353	7350022732360	N/A	21 €
T Joints	33 mm	7350022733169	7350022733176	N/A	12 €
	50 mm	7350022733190	7350022733206	7350022733213	15 €

# MANUAL PROJECTION SCREENS DELUXE

## ELEGANT DESIGN & SUPERIOR MATERIAL CHOICES

Le Screen Manual Self-Lock Projection Screen Deluxe are elegant projection screens designed with a aluminum cassette, high-end for the living room, home theatre, conference rooms or for educational use in schools. With a sleek Nordic design this projection screen fits any environment it is installed in.

The Le Screen Projection Screens are easy to install and even easier to use. Just sit back and enjoy the show! Non compromised material choices is used when making a Le Screen Manual Screen giving you market leading technical specifications and optimized picture quality.

### Slow retention

A slow retention function is built into the manual screens. This makes the screen retract slowly and controlled retract into the cassette. This prolong the lifetime (normally doubles the life expectancy) of the projection screen and makes the manual screen usable in more public environments where multiple users handle the screen every day.

### Superior screen material

The quality of screen material is the most important aspect of any projection screen. Most screens on the market will use a very basic compressed cloth type material resulting in a creased surface and poor contrast performance. The Le Screen Projection Screen Deluxe series use a high quality multi ply material with a high contrast and low gain of 1.0. The material is tear resistant, fireproof, anti wrinkle

safe and is designed to hang flat. The centre layer is a glass fibre net producing a flex rate of less than 1% compared with the industry average of 33%. The front layer optimizes contrast and reflectivity while a black PVC backing prevents light leakage and helps retain a uniformly flat projection surface.

### Elegant design

Le Screen Manual Self-Lock Projection Screens Deluxe are an elegant series of manual screens. The cassette is all aluminum coated in white paint. High quality details & superior design makes this piece a beauty among projection screens.

### Formats

Available in 16:9, 16:10, 4:3 or 1:1. (16:9, 16:10, 4:3 are surrounded by a black boarder for contrast).

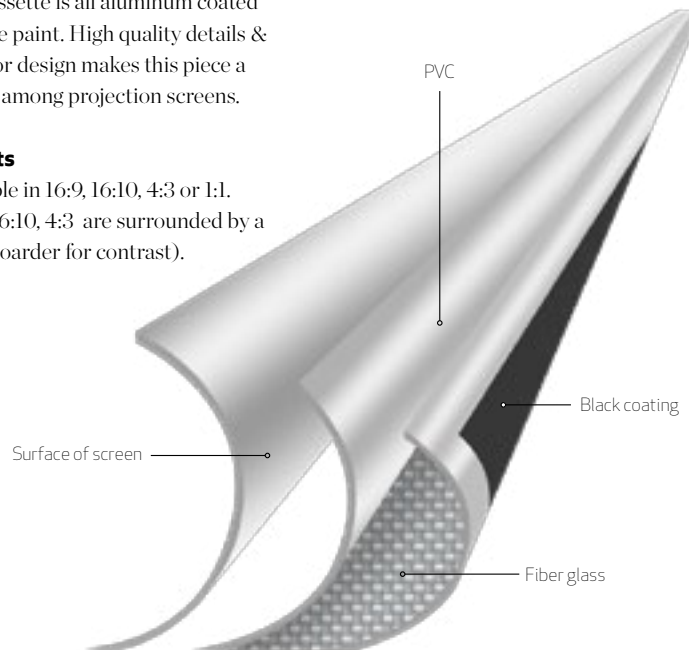

# MANUAL PROJECTION SCREENS DELUXE

## ELEGANT DESIGN & SUPERIOR MATERIAL CHOICES

Le Screen Manual Self-Lock Projection Screen Deluxe are elegant projection screens designed with a aluminum cassette, high-end for the living room, home theatre, conference rooms or for educational use in schools. With a sleek Nordic design this projection screen fits any environment it is installed in.

The Le Screen Projection Screens are easy to install and even easier to use. Just sit back and enjoy the show! Non compromised material choices is used when making a Le Screen Manual Screen giving you market leading technical specifications and optimized picture quality.

### Slow retention

A slow retention function is built into the manual screens. This makes the screen retract slowly and controlled retract into the cassette. This prolong the lifetime (normally doubles the life expectancy) of the projection screen and makes the manual screen usable in more public environments where multiple users handle the screen every day.

### Superior screen material

The quality of screen material is the most important aspect of any projection screen. Most screens on the market will use a very basic compressed cloth type material resulting in a creased surface and poor contrast performance. The Le Screen Projection Screen Deluxe series use a high quality multi ply material with a high contrast and low gain of 1.0. The material is tear resistant, fireproof, anti wrinkle

safe and is designed to hang flat. The centre layer is a glass fibre net producing a flex rate of less than 1% compared with the industry average of 33%. The front layer optimizes contrast and reflectivity while a black PVC backing prevents light leakage and helps retain a uniformly flat projection surface.

### Elegant design

Le Screen Manual Self-Lock Projection Screens Deluxe are an elegant series of manual screens. The cassette is all aluminum coated in white paint. High quality details & superior design makes this piece a beauty among projection screens.

### Formats

Available in 16:9, 16:10, 4:3 or 1:1. (16:9, 16:10, 4:3 are surrounded by a black boarder for contrast).

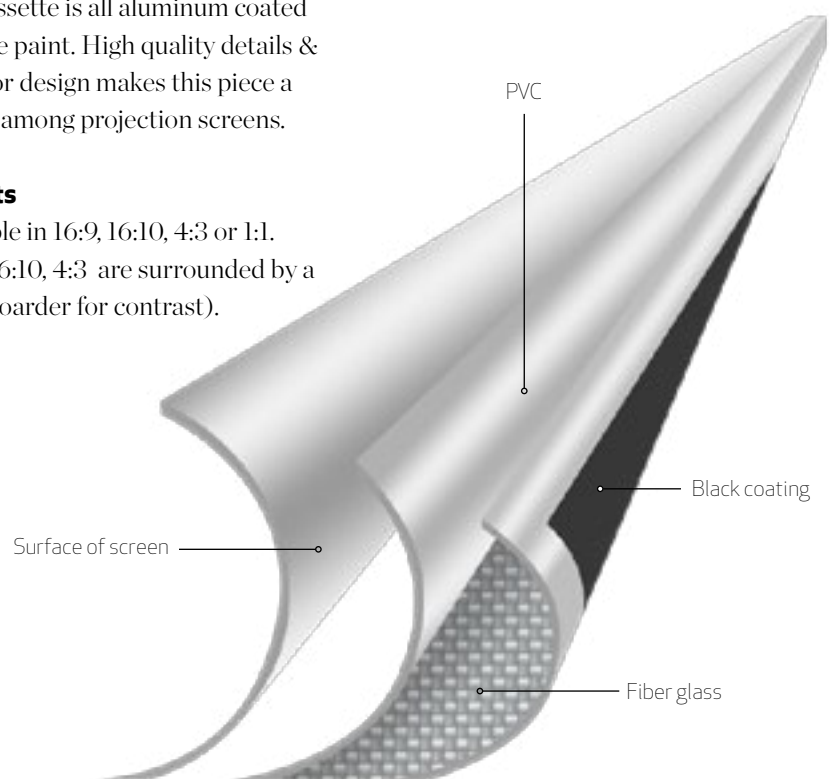

High Quality Aluminum Case  
lightweight yet durable

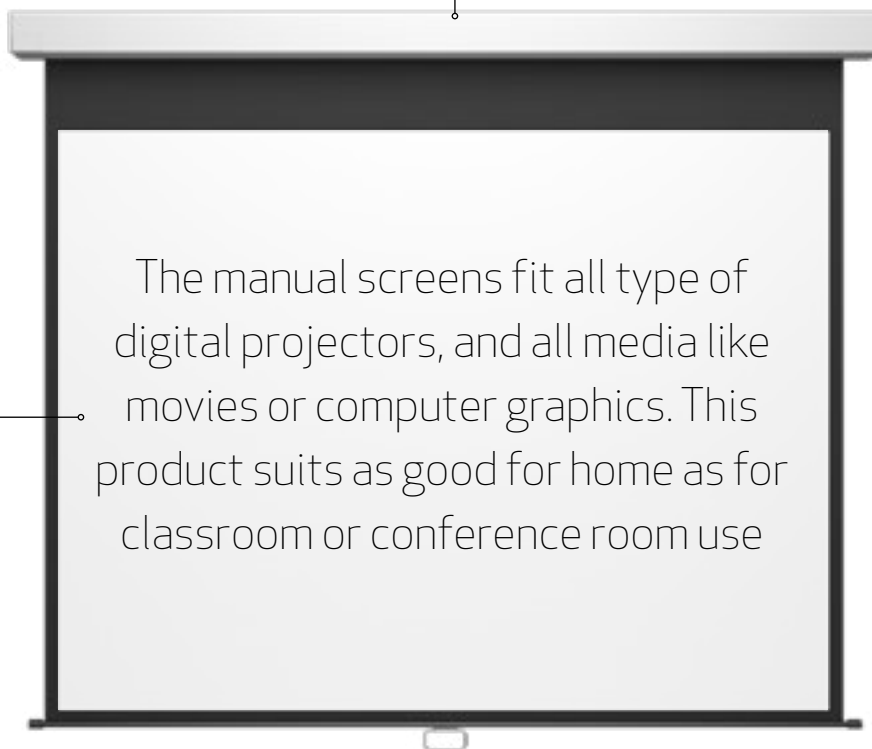

Cleanable Screen Material  
for easy maintenance

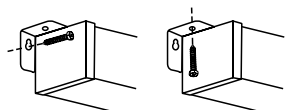

Wall/Ceiling mounting  
For multiple placement options

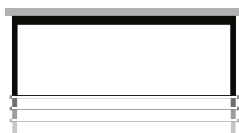

Slow Retention Design  
For smooth screen retraction

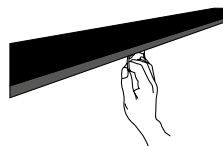

Durable Handle  
Easily pulls down the screen

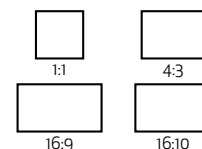

Multiple Aspect Ratios

## MANUAL PROJECTION SCREENS:

- Available with aspect ratios: 16:9, 16:10, 4:3 and 1:1
- High quality aluminum cassette
- Slow retention & high quality details for longer life
- Market leading screen fabric gain 1.0
- Mounts for ceiling or wall installations included
- 30 centimeter black drop



### M 1:1 Manual Projection Screens White Edition

Size:	Article Nr:	Projection Area:	Diagonal	Cassette colour:	Cassette material:	Surface:	Gain:	Wieght:	White drop:	Cassette size: (L*W*H)	Warranty:
80"	7350 073 73 7154	1,45x1,45 m	2,03 m	White	Aluminum	Matte white	1,0	8 kg	30 cm	160x7,2x8,2 cm	1 year
96"	7350 073 73 7161	1,76 x 1,76 m	2,44 m	White	Aluminum	Matte white	1,0	8,5 kg	30 cm	181x7,2x8,2 cm	1 year
112"	7350 022 73 1981	2x2 m	2,84 m	White	Aluminum	Matte white	1,0	9 kg	30 cm	213x7,2x8,2 cm	1 year
135"	7350 073 73 7178	2,4x2,4 m	3,45 m	White	Aluminum	Matte white	1,0	12 kg	30 cm	249x10x8,2 cm	1 year

M 4:3 Manual Projection Screen 200x150, 100"

<b>Article No:</b>	7 350 022 730 595
<b>Format:</b>	4:3
<b>Size:</b>	100"
<b>Projection area:</b>	2x1,5 m
<b>Diagonal:</b>	2,54 m
<b>Motor:</b>	No
<b>Remote:</b>	No
<b>Colour:</b>	White
<b>Surface:</b>	Matte white
<b>Gain:</b>	1,0
<b>Border:</b>	4,5 cm
<b>Weight:</b>	9 kg
<b>Black drop:</b>	30 cm
<b>Cassette material:</b>	Aluminum
<b>Cassette measurements:</b>	213x7,2x8,2 cm (L*W*H)
<b>Warranty:</b>	1 year
<b>Slow retention:</b>	Built-in



M 16:9 Manual Projection Screen 200x112, 90"

<b>Article No:</b>	7 350 022 730 588
<b>Format:</b>	16:9
<b>Size:</b>	90"
<b>Projection area:</b>	2 x 1,12 m
<b>Diagonal:</b>	2,29 m
<b>Motor:</b>	No
<b>Remote:</b>	No
<b>Colour:</b>	White
<b>Surface:</b>	Matte white
<b>Gain:</b>	1,0
<b>Border:</b>	4,5 cm
<b>Weight:</b>	8 kg
<b>Black drop:</b>	30 cm
<b>Cassette material:</b>	Aluminum
<b>Cassette measurements:</b>	213x7,2x8,2 cm (L*W*H)
<b>Warranty:</b>	1 year
<b>Slow retention:</b>	Built-in

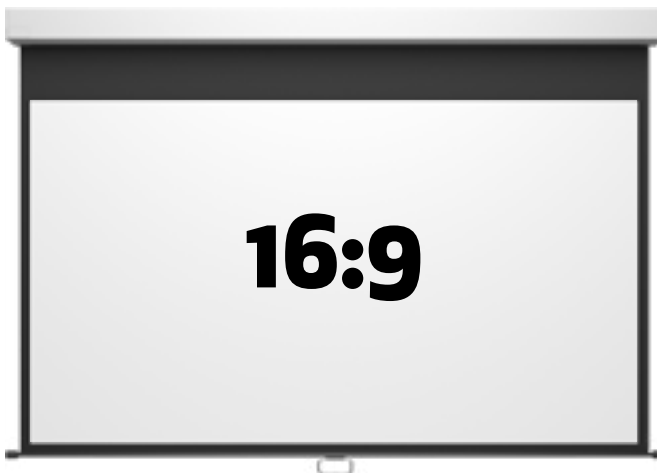

M 16:10 Manual Projection Screen 232x145, 108"

<b>Article No:</b>	7 350 022 735 682
<b>Format:</b>	16:10
<b>Size:</b>	108"
<b>Projection area:</b>	2,33 x 1,45 m
<b>Diagonal:</b>	2,74 m
<b>Motor:</b>	No
<b>Remote:</b>	No
<b>Colour:</b>	White
<b>Surface:</b>	Matte white
<b>Gain:</b>	1,0
<b>Border:</b>	4,5 cm
<b>Weight:</b>	11 kg
<b>Black drop:</b>	30 cm
<b>Cassette material:</b>	Aluminum
<b>Cassette measurements:</b>	248x7,2x8,2 cm (L*W*H)
<b>Warranty:</b>	1 year
<b>Slow retention:</b>	Built-in









*le Screen*  
BY MULTIBRACKETS

**TAKE YOUR  
PRESENTATIONS TO  
THE NEXT LEVEL**

**WITH HIGH-END  
PROJECTION SCREENS**

**MOTORIZED PROJECTION  
SCREENS DELUXE**

# MOTORIZED PROJECTION SCREENS DELUXE

## ELEGANT DESIGN & SUPERIOR MATERIAL CHOICES

Our motorized projection screens are designed to increase functionality and performance for today's presentation environments. Also by being motorized and not handled by hand it will last much longer than its manual counterparts. Crafted to strict Le Screen standards, these innovative screens are now available in widths from 77" to a massive 334" (or 8,5m diagonal).

Le Screen Motorized Screens also feature seamless height adjustments for a picture perfect reproduction in the most challenging environments. Le Screen standard fabric is a Gain 1.0 and our screen cloth is using a high levelled three layer technology. Le Screen can also custom produce screens with different fabrics built to a project's specification. Supporting most popular aspect ratios: 16:9, 16:10, 4:3, and 1:1 we are almost certain we have a Motorized Projection Screen that fits your needs.

### Superior screen material

The quality of screen material is the most important aspect of any projection screen. Most screens on the market will use a very basic compressed cloth type material resulting in a creased surface and poor contrast performance. The Le Screen Motorized Projection Screen Deluxe series use a high quality multi layered ply material with a high contrast and low gain of 1.0. The material is tear resistant, fireproof, anti wrinkle safe and is designed to hang flat. The centre layer is a glass fibre net producing a flex rate of less than 1% compared with the industry average of 33%. The front layer optimizes contrast and reflectivity while a black PVC backing prevents light leakage and helps retain a uniformly flat projection surface.



Wall Receiver & RF Remote Control  
Operates from long distances



Cleanable screen material  
for easy maintenance

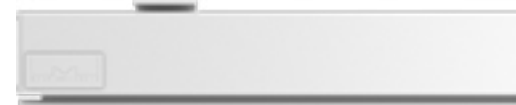



Multiple Aspect Ratios



Quiet Tubular Motor



CE-Quality Mark

High Quality Aluminum Case  
Lightweight yet durable



## HIGHLIGHTS:

- Available with aspect ratios:16:9, 16:10, 4:3 and 1:1
- Adjustments possibilities are easy to reach inside the case
- Pre programmed final setting for rolling in and out of projection screen makes rapid installation possible
- All Motorized projection screens follows the product safety standards with CE-quality mark
- The motor with 28RPM is incredibly quiet
- Supplied with mounting details for ceiling and wall installation
- Matte white, double-sided laminated vinyl with black back, and fiber glass centre (three layered technology) gain 1.0, viewing angle over 50 degrees left and right,weight approximately 450g/m<sup>2</sup> and thickness approximately 0.45mm.
- Le Screen Motorized Projection Screens Deluxe support formats 16:9, 16:10, 4:3, and 1:1
- Black border of 4cm around the viewing area (16:9, 16:10 and 4:3)
- Black/white drop 30cm
- Case colors available in white and black
- Sliding wall mounts ensure the installation is properly centered.

### MOUNTING METHOD DEPENDS ON CASSETTE TYPE



77" to 167"

180" to 226"

226" to 334"

Cassette  
type/size:

Mounting  
method:

**SMALL**

**A**

**MEDIUM**

**B**

**LARGE**

**C**

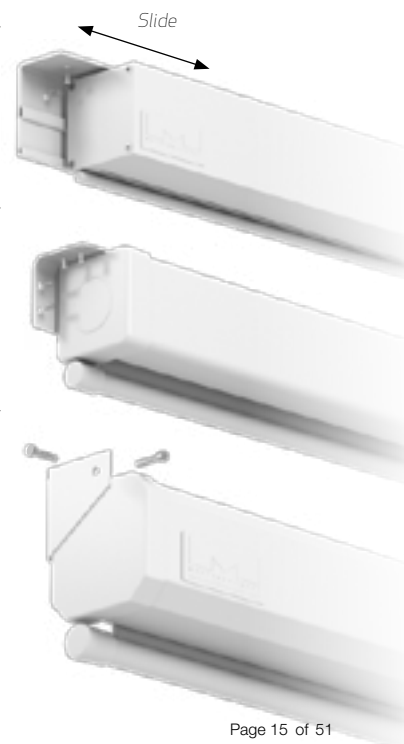



### M 1:1 Motorized Projection Screens - White Edition

Size:	Article Nr:	Projection Area:	Diagonal	Motor:	Remote:	Cassette colour:	Cassette material:	Surface:	Gain:	Wieght:	White drop:	Cassette size: (L*W*H)	Warranty:
80"	7 350 022 730 830	1,45x1,45 m	2,03 m	Yes	Yes	White	Aluminum	Matte white	1,0	11 kg	30 cm	158,4x9x9 cm	1 year
96"	7 350 022 731 721	1,72x1,72 m	2,44 m	Yes	Yes	White	Aluminum	Matte white	1,0	12 kg	30 cm	185,4x9x9 cm	1 year
112"	7 350 022 730 847	2x2 m	2,84 m	Yes	Yes	White	Aluminum	Matte white	1,0	14 kg	30 cm	213,4x9x9 cm	1 year
135"	7 350 022 731 738	2,4x2,4 m	3,43 m	Yes	Yes	White	Aluminum	Matte white	1,0	18 kg	30 cm	255,4x9x9 cm	1 year
167"	7 350 022 731 745	3x3 m	4,24 m	Yes	Yes	White	Aluminum	Matte white	1,0	19 kg	30 cm	315,4x9x9 cm	1 year
200"	7 350 022 731 752	3,6x3,6 m	5,08 m	Yes	Yes	White	Aluminum	Matte white	1,0	32 kg	30 cm	378x9,8x9,8 cm	1 year
278"	7 350 022 731 776	5x5 m	7,06 m	Yes	Yes	White	Aluminum	Matte white	1,0	150 kg	30 cm	518x15,3x15,3 cm	1 year
334"	7 350 022 731 783	6x6 m	8,48 m	Yes	Yes	White	Aluminum	Matte white	1,0	129 kg	30 cm	618x17,5x17,5 cm	1 year



## M 4:3 Motorized Projection Screens

Size:	Article Nr:	Projection Area:	Diagonal	Motor:	Remote:	Cassette colour:	Cassette material:	Surface:	Gain:	Wieght:	Black drop:	Cassette size: (L*W*H)	Warranty:
86"	7 350 022 730 366	1,72x1,3m	2,18 m	Yes	Yes	White	Aluminum	Matte white	1,0	11 kg	30 cm	185,4x9x9 cm	1 year
100"	7 350 022 730 373	2x1,5m	2,54 m	Yes	Yes	White	Aluminum	Matte white	1,0	12 kg	30 cm	213,9x9x9 cm	1 year
120"	7 350 022 730 380	2,4x1,8m	3,05 m	Yes	Yes	White	Steel	Matte white	1,0	14 kg	30 cm	257x9x9 cm	1 year
150"	7 350 022 730 458	3x2,2m	3,81 m	Yes	Yes	White	Steel	Matte white	1,0	17kg	30 cm	315,4x9x9 cm	1 year
180"	7 350 022 730 465	3,6x2,7m	4,57 m	Yes	Yes	White	Steel	Matte white	1,0	32 kg	30 cm	378x9,8x9,8 cm	1 year
200"	7 350 022 730 472	4x3m	5,08	Yes	Yes	White	Steel	Matte white	1,0	38 kg	30 cm	418x9,8x9,8 cm	1 year
300"	7 350 022 730 496	6x4,5m	7,62 m	Yes	Yes	White	Steel	Matte white	1,0	125kg	30 cm	624x17,5x17,5 cm	1 year

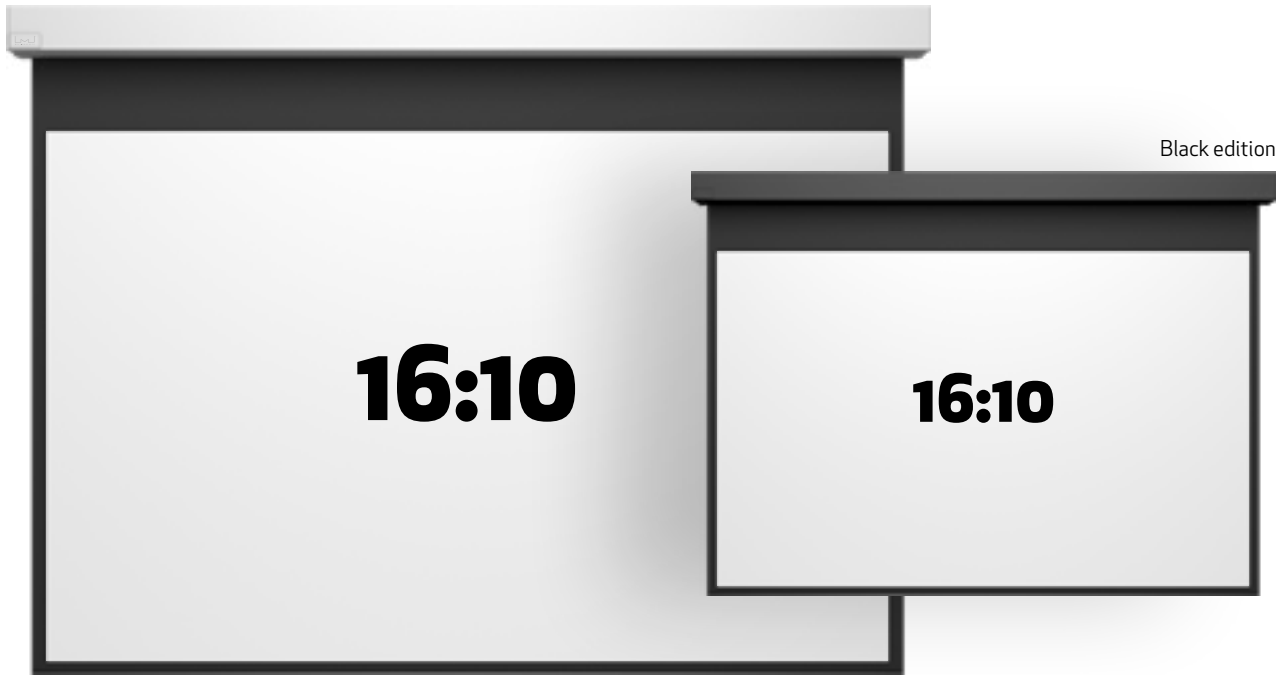

### M16:10 Motorized Projection Screen

#### White cassette

Size:	Article Nr:	Projection Area:	Diagonal	Motor:	Remote:	Cassette colour:	Cassette material:	Surface:	Gain:	Border:	Wieght:	Black drop:	Cassette size: (L*W*H)	Warranty:
77"	7 350 022 730 403	1,72x0,97m	1,96 m	Yes	Yes	White	Aluminum	Matte white	1,0	4 cm	10 kg	30 cm	185,4x9x9 cm	1 year
90"	7 350 022 730 410	2x1,12m	2,29 m	Yes	Yes	White	Aluminum	Matte white	1,0	4 cm	12 kg	30 cm	215,4x8,2x7,2 cm	1 year
108"	7 350 022 730 427	2,4x1,35m	2,74 m	Yes	Yes	White	Aluminum	Matte white	1,0	4,5 cm	14 kg	30 cm	255,4x9x9 cm	1 year
135"	7 350 022 730 526	3x1,68m	3,43 m	Yes	Yes	White	Aluminum	Matte white	1,0	4 cm	18 kg	30 cm	317x10x8,2 cm	1 year
162"	7 350 022 730 533	3,6x2 m	4,11 m	Yes	Yes	White	Steel	Matte white	1,0	4,5 cm	34 kg	30 cm	378x9,8x9,8 cm	1 year
180"	7 350 022 730 540	4x2,25m	4,57 m	Yes	Yes	White	Steel	Matte white	1,0	4,5 cm	36 kg	30 cm	418x9,8x9,8 cm	1 year
226"	7 350 022 730 557	5x2,81m	5,74 m	Yes	Yes	White	Steel	Matte white	1,0	5,5 cm	130 kg	30 cm	518x15,3x15,3 cm	1 year
280"	7 350 022 730 564	6x3,38m	7,11 m	Yes	Yes	White	Steel	Matte white	1,0	5,5 cm	122 kg	30 cm	618x17,5x17,5 cm	1 year

#### Black edition (Black cassette, black wall remote & black remote control)

Size:	Article Nr:	Projection Area:	Diagonal	Motor:	Remote:	Cassette colour:	Cassette material:	Surface:	Gain:	Border:	Wieght:	Black drop:	Cassette size: (L*W*H)	Warranty:
77"	7 350 022 733 978	1,72x0,97m	1,96 m	Yes	Yes	Black	Aluminum	Matte white	1,0	4,5 cm	10 kg	30 cm	185,4x9x9 cm	1 year
90"	7 350 022 732 629	2x1,12m	2,29 m	Yes	Yes	Black	Aluminum	Matte white	1,0	4,5 cm	12 kg	30 cm	213,4x9x9 cm	1 year
108"	7 350 022 732 636	255,4x9x9 cm	2,74 m	Yes	Yes	Black	Aluminum	Matte white	1,0	4,5 cm	15 kg	30 cm	255,4x9x9 cm	1 year
135"	7 350 022 733 985	3x1,68m	3,43 m	Yes	Yes	Black	Aluminum	Matte white	1,0	4,5 cm	18 kg	30 cm	315,4x9x9 cm	1 year

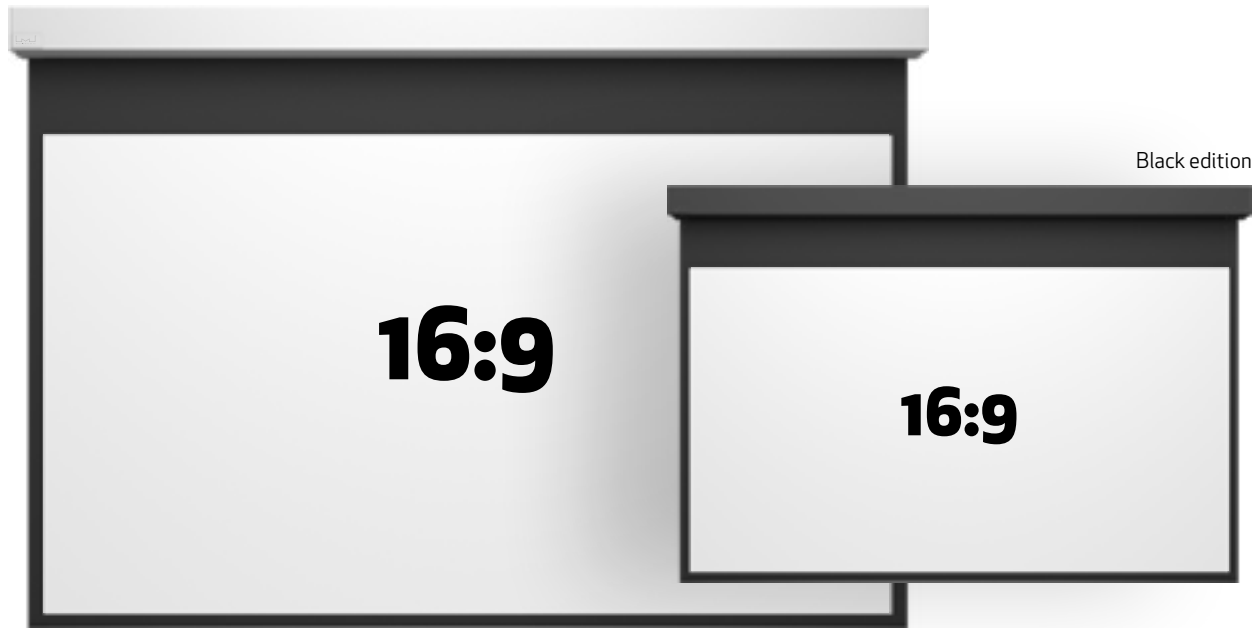

### M16:9 Motorized Projection Screen

#### White cassette

Size:	Article Nr:	Projection Area:	Diagonal	Motor:	Remote:	Cassette colour:	Cassette material:	Surface:	Gain:	Border:	Wieght:	Black drop:	Cassette size: (L*W*H)	Warranty:
77"	7 350 022 735 569	1,659 x 1,037 m	196 cm	Yes	Yes	White	Aluminum	Matte white	1,0	4 cm	11 kg	30 cm	180,9 x 9 x 9 cm	1 year
90"	7 350 022 735 583	1,939 x 1,212 m	229 cm	Yes	Yes	White	Aluminum	Matte white	1,0	4 cm	14 kg	30 cm	208,9 x 9 x 9 cm	1 year
108"	7 350 022 735 606	2,326 x 1,454 m	274 cm	Yes	Yes	White	Aluminum	Matte white	1,0	4 cm	16 kg	30 cm	247,6 x 9 x 9 cm	1 year
135"	7 350 022 735 620	2,908 x 1,817 m	343 cm	Yes	Yes	White	Aluminum	Matte white	1,0	4 cm	19 kg	30 cm	307,8 x 9 x 9 cm	1 year
162"	7 350 022 735 644	3,489 x 2,18 m	411 cm	Yes	Yes	White	Steel	Matte white	1,0	4 cm	33 kg	30 cm	364,9 x 10 x 10 cm	1 year
180"	7 350 022 735 651	3,877 x 2,432 m	458 cm	Yes	Yes	White	Steel	Matte white	1,0	4 cm	35 kg	30 cm	402,7 x 10 x 10 cm	1 year
226"	7 350 022 735 668	4,868 x 3,042 m	574 cm	Yes	Yes	White	Steel	Matte white	1,0	4 cm	45 kg	30 cm	512,8 x 10 x 10 cm	1 year
280"	7 350 022 735 675	6,031 x 3,77 m	711 cm	Yes	Yes	White	Steel	Matte white	1,0	4 cm	50 kg	30 cm	629,1 x 17 x 17 cm	1 year

#### Black edition (Black cassette, black wall remote & black remote control)

Size:	Article Nr:	Projection Area:	Diagonal	Motor:	Remote:	Cassette colour:	Cassette material:	Surface:	Gain:	Border:	Wieght:	Black drop:	Cassette size: (L*W*H)	Warranty:
77"	7 350 022 735 576	1,659 x 1,037 m	196 cm	Yes	Yes	Black	Aluminum	Matte white	1,0	4,5 cm	11 kg	30 cm	180,9 x 9 x 9 cm	1 year
90"	7 350 022 735 590	1,939 x 1,212 m	229 cm	Yes	Yes	Black	Aluminum	Matte white	1,0	4,5 cm	14 kg	30 cm	208,9 x 9 x 9 cm	1 year
108"	7 350 022 735 613	2,326 x 1,454 m	274 cm	Yes	Yes	Black	Aluminum	Matte white	1,0	4,5 cm	16 kg	30 cm	247,6 x 9 x 9 cm	1 year
135"	7 350 022 735 637	2,908 x 1,817 m	343 cm	Yes	Yes	Black	Aluminum	Matte white	1,0	4,5 cm	16 kg	30 cm	307,8 x 9 x 9 cm	1 year

## ACCESSORIES

### Motorized Projection Screens

#### MIR Reciever / Transmitter Kitt

<b>Article No:</b>	7 350 022 73 2315
<b>Colour:</b>	White
<b>Material:</b>	Plastic
<b>Warranty:</b>	1 year
<b>Signal frequency:</b>	38 KHz



#### M12V Trigger Kit for MB Motorized Screens

<b>Article No:</b>	7 350 022 73 3770
<b>Colour:</b>	White
<b>Material:</b>	Plastic
<b>Warranty:</b>	1 year
<b>Signal frequency:</b>	38 KHz
<b>Voltage:</b>	220 V



#### Control Box

<b>Article No:</b>	7 350 073 73 9868
<b>Colour:</b>	White
<b>Material:</b>	Plastic
<b>Warranty:</b>	1 year
<b>Signal frequency:</b>	38 KHz





## PARTS

### Motorized / Manual Projection screens



Pair of Wall / Ceiling Mount  
for Manual & Motorized Screens up to 135"

<b>Article No (white):</b>	7350 073 73 9875
<b>Article No (black):</b>	7350 073 73 9882
<b>Material:</b>	Metal
<b>Warranty:</b>	5 years



Black Drop Stick

<b>Article No:</b>	7350 073 73 9899
<b>Colour:</b>	Yellow
<b>Material:</b>	Plastic
<b>Warranty:</b>	5 year



M Wall-Remote Control Black  
for Motorized Screens

<b>Article No:</b>	7350 073 73 9905
<b>Colour:</b>	Black
<b>Material:</b>	Plastic
<b>Warranty:</b>	1 year
<b>Signal frequency:</b>	38 KHz
<b>Voltage:</b>	220 V



M Remote Control Black  
for Motorized Screens

<b>Article No:</b>	7350 073 73 9929
<b>Colour:</b>	Black
<b>Material:</b>	Plastic
<b>Warranty:</b>	1 year
<b>Signal frequency:</b>	38 KHz
<b>Voltage:</b>	12 V



M Wall-Remote Control White  
for Motorized Screens

<b>Article No:</b>	7350 073 73 9912
<b>Colour:</b>	White
<b>Material:</b>	Plastic
<b>Warranty:</b>	1 year
<b>Signal frequency:</b>	38 KHz
<b>Voltage:</b>	220 V



M Remote Control White  
for Motorized Screens

<b>Article No:</b>	7350 073 73 9936
<b>Colour:</b>	White
<b>Material:</b>	Plastic
<b>Warranty:</b>	1 year
<b>Signal frequency:</b>	38 KHz
<b>Voltage:</b>	220 V





*le Screen*<sup>®</sup>

BY MULTIBRACKETS

**FRAMED PROJECTION  
SCREENS**

# FRAMED PROJECTION SCREENS

## ELEGANT DESIGN & SUPERIOR MATERIAL CHOICES

Our ultra flat framed screens reach a perfectly smooth surface. With a frame that is just 30 mm thick, it looks rather like an LCD than a projection screen. It's simple and linear shape harmonizes beautifully. Available from 77" to massive 226".

Our Framed series is a best seller in EU perfect for Boardrooms, Corporate Information Suites, Reception areas and other prestige business locations. Our line of framed screens are also perfect for smaller viewing theatres, visitor centers, museums and other select presentation venues. The screens are based on a high quality screen cloth. Producing a 1.0 gain with a superior extra wide viewing angle.

Our Framed screens use a simply ingenious tensioning system, you're sure to get a wrinklefree and super straight image every time. Le Screen framed screen value means big audiences get big screens without having to compromise on the experience. The result is a viewing environment that delivers on movie makers creative vision. A result so immersive it must be experienced.

Our series Fixed projection screens are tailored to fit the bill for high-end fixed screens and viewers wanting high quality and good economy. Selected framed screens has the option to use Le Screen Grey Plus Cloth (Gain 0.9) or our Acoustically transparent screen technology.

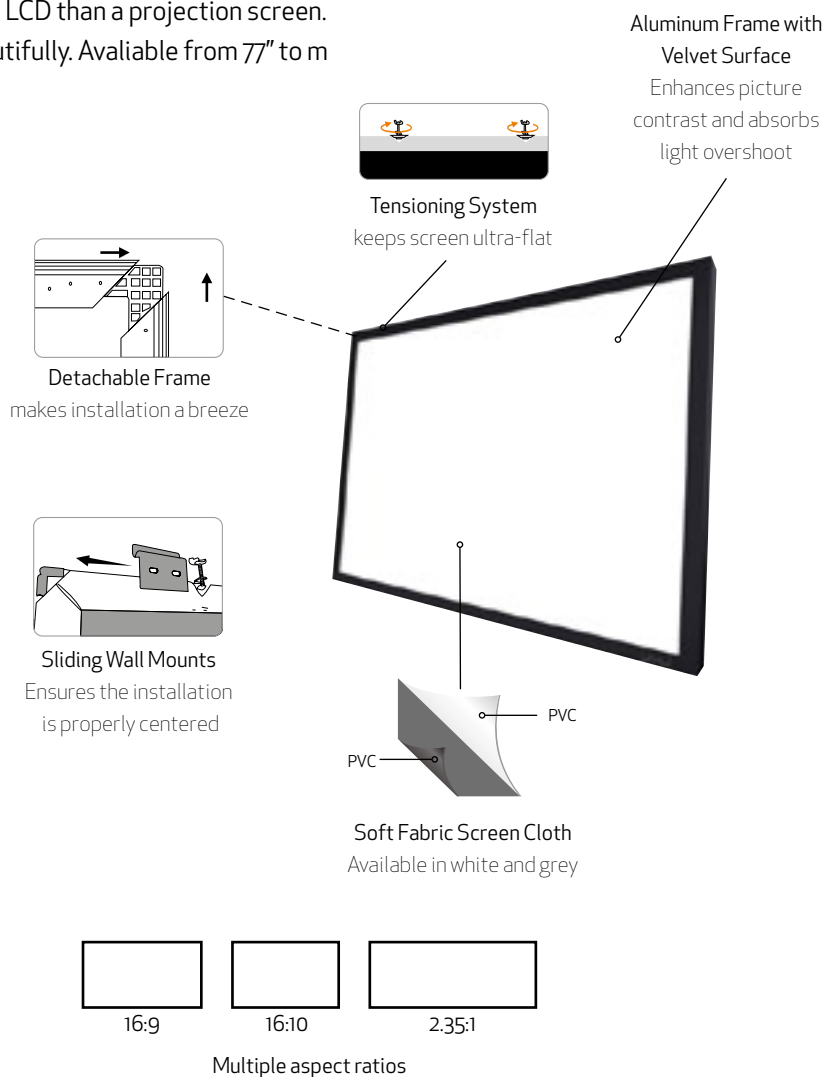

## FRAMED PROJECTION SCREENS

- Multiple aspect ratios available: 16:9, 16:10 and 2.35:1
- Highly versatile 1.0 flat-tensioned screen material with standard black backing to eliminate light penetration.
- Aluminum contour frame surfaced with black velvet to enhance picture contrast and absorb light overshoot.
- Slide-on wall mount is horizontally adjustable for easy centering.
- Designed for high performance Home Cinema Projectors.

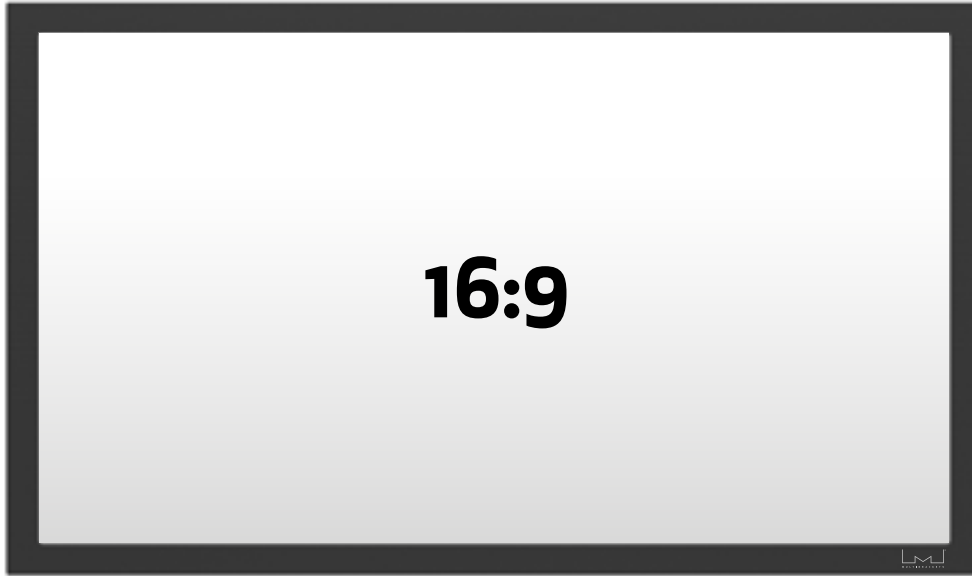

## M 16:9 Framed Projection Screen

Size:	Article Nr:	Projection Area:	Diagonal	Frame colour:	Surface:	Gain:	Frame:	Wieght:	Single package measurements:	Warranty:
77"	7 350 022 731 936	1,72 x 0,97 m	1,96 m	Black	Matte white	1,0	8 cm	11 kg	190 x 22 x 14 cm	1 year
90"	7 350 022 730 724	2 x 1,12 m	2,29 m	Black	Matte white	1,0	8 cm	12 kg	218 x 22 x 14 cm	1 year
100"	7 350 022 733 473	2,21 x 1,26 m	2,92 m	Black	Matte white	1,0	8 cm	13 kg	240 x 22 x 14 cm	1 year
108"	7 350 022 732 964	2,40 x 1,35 m	2,74 m	Black	Matte white	1,0	8 cm	15 kg	258 x 22 x 14 cm	1 year
120"	7 350 022 733 619	2,65 x 1,49 m	3,5 m	Black	Matte white	1,0	8 cm	16 kg	283 x 22 x 14 cm	1 year
135"	7 350 022 732 971	3,00 x 1,68 m	3,43 m	Black	Matte white	1,0	8 cm	17 kg	318 x 22 x 14 cm	1 year
150"	7 350 022 733 626	3,32 x 1,86 m	4,37 m	Black	Matte white	1,0	8 cm	24 kg	350 x 22 x 14 cm	1 year
162"	7 350 022 733 633	3,58 x 2,04 m	4,73 m	Black	Matte white	1,0	12 cm	34 kg	404 x 23,5 x 23,5 cm	1 year
180"	7 350 022 733 640	3,98 x 2,26 m	5,26 m	Black	Matte white	1,0	12 cm	40 kg	444 x 23,5 x 23,5 cm	1 year
226"	7 350 022 733 657	4,99 x 2,84 m	6,60 m	Black	Matte white	1,0	12 cm	50 kg	544 x 23,5 x 23,5 cm	1 year

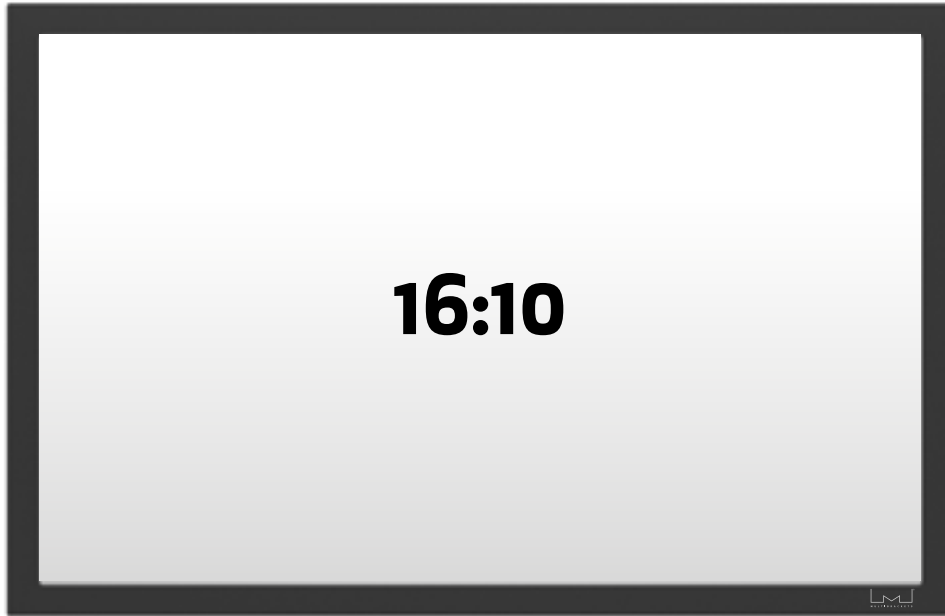

### M 16:10 Framed Projection Screen

Size:	Article Nr.:	Projection Area:	Diagonal	Frame colour:	Surface:	Gain:	Frame:	Wieght:	Single package measurements:	Warranty:
77"	7350 022 735 750	1,66 x 1,04 m	1,95 m	Black	Matte white	1,0	8 cm	10 kg	185 x 22 x 14 cm	1 year
90"	7350 022 735 767	1,94 x 1,21 m	2,29 m	Black	Matte white	1,0	8 cm	12 kg	212 x 22 x 14 cm	1 year
100"	7350 022 735 774	2,15 x 1,35 m	2,54 m	Black	Matte white	1,0	8 cm	14 kg	234 x 22 x 14 cm	1 year
108"	7350 022 735 781	2,33 x 1,62 m	2,74 m	Black	Matte white	1,0	8 cm	15 kg	2,33 x 1,62 m	1 year
120"	7350 022 735 798	2,59 x 1,62 m	3,05 m	Black	Matte white	1,0	8 cm	15 kg	2,59 x 1,62 m	1 year
135"	7350 022 735 804	2,91 x 1,82 m	3,43 m	Black	Matte white	1,0	8 cm	20 kg	2,91 x 1,82 m	1 year
150"	7350 022 735 811	3,23 x 2,02 m	3,81 m	Black	Matte white	1,0	8 cm	34 kg	341 x 22 x 14 cm	1 year
162"	7350 022 735 828	3,49 x 2,18 m	4,11 m	Black	Matte white	1,0	12 cm	36 kg	393 x 23,5 x 23,5 cm	1 year
180"	7350 022 735 835	3,88 x 2,42 m	4,57 m	Black	Matte white	1,0	12 cm	41 kg	32 x 23,5 x 23,5 cm	1 year
225"	7350 022 735 842	4,87 x 3,04 m	5,74 m	Black	Matte white	1,0	12 cm	48 kg	531 x 23,5 x 23,5 cm	1 year

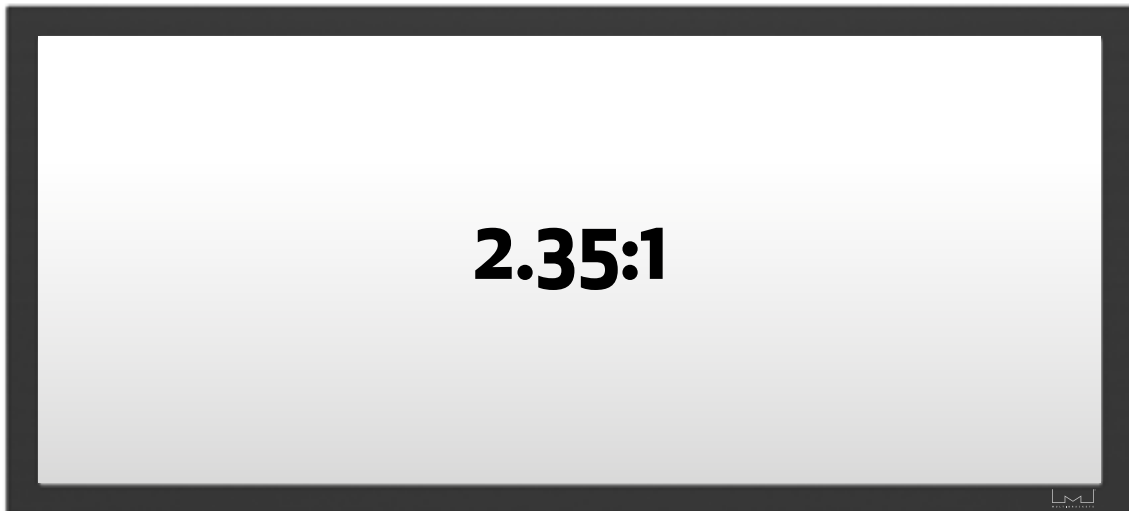

## M 2.35:1 Framed Projection Screen

Size:	Article Nr:	Projection Area:	Diagonal:	Frame colour:	Surface:	Gain:	Frame:	Wieght:	Single package measurements:	Warranty:
84"	7 350 022 732 551	1,97x0,84 m	2,13 m	Black	Matte white	1,0	8 cm	11 kg	215 x 22 x 14 cm	1 year
90"	7 350 022 732 568	2,11 x 0,9 m	2,29 m	Black	Matte white	1,0	8 cm	12 kg	230 x 22 x 14 cm	1 year
100"	7 350 022 732 575	2,34 x 1 m	2,54 m	Black	Matte white	1,0	8 cm	14 kg	252 x 22 x 14 cm	1 year
108"	7 350 022 732 582	2,81x1,2 m	3,05m	Black	Matte white	1,0	8 cm	16 kg	300 x 22 x 14 cm	1 year
120"	7 350 022 734 531	2,54 x 1,08 m	2,74 m	Black	Matte white	1,0	8 cm	15 kg	272 x 22 x 14 cm	1 year
135"	7 350 022 734 548	3,17x1,35 m	3,43m	Black	Matte white	1,0	8 cm	20 kg	335 x 22 x 14 cm	1 year
150"	7 350 022 734 555	3,43 x 1,46 m	3,73 m	Black	Matte white	1,0	12 cm	30 kg	387x23,5x23,5 cm	1 year
162"	7 350 022 734 562	3,78 x 1,61 m	4,11 m	Black	Matte white	1,0	12 cm	36 kg	422x23,5x23,5 cm	1 year
180"	7 350 022 734 579	4,23 x 1,8 m	4,57 m	Black	Matte white	1,0	12 cm	41 kg	467x23,5x23,5 cm	1 year
200"	7 350 022 734 586	4,6x1,95 m	5,08 m	Black	Matte white	1,0	12 cm	45 kg	504x23,5x23,5 cm	1 year

# M GREY PLUS EXTRA CLOTH

## GET THE BEST PICTURE QUALITY FOR THEIR FIXED FRAME SOLUTION

This projection screen surface is optimized for any user striving to get the best picture quality for their fixed frame solution. Overall the M Grey Plus generally provides higher contrast and better colour rendition than a standardized matte white projection screen surface.

The grey screen surface is the perfect choice when video images are the main source of information being projected and where ambient lighting is moderately controlled. With its specially designed grey base surface and a reflective top surface, this screen material is able to provide very good black levels without sacrificing the white level output. With its enhanced black levels and brilliant white levels, this screen surface provides deep life-like colours and greater detail and sharpness to the image.

M Grey Plus projection screen surface ensures a dramatic improvement of contrast display for any projector.

M Grey Plus is available in all fixed framed screens sizes, and is purchased separately.

### GAIN: SCREEN REFLECTIVITY

The image luminance is the overall image brightness created by the combination of projector output and screen reflectivity. Projection screens vary in their reflective properties. The reflective neutral matte white screen is typically 1.0 gain but can vary as high as 1.4 in its reflectivity. Negative gain projection screens are designed to enhance

contrast levels at the expense of having less reflectivity. They are typically measured between 0.5 to 0.9 gain. Ambient Light Rejecting or ALR projection screens typically perform in the realm positive gain, or anything higher than 1.0 to 1.8 gain. These screens are known for superior brightness and image saturation, however they can also be negative gain as heavy contrast layers are incorporated to enhance darkness levels for superior image quality.

## 0.9 GAIN

Negative gain projection screens are designed to enhance contrast levels at the expense of having less reflectivity.

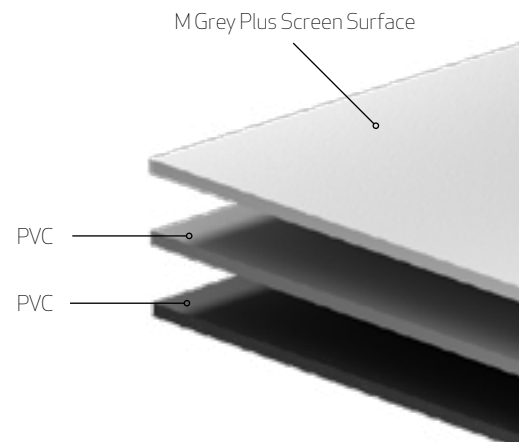



## 16:10

Size:	Article Nr:	Format:	Gain:	Frame:	Warranty:
77"	7 350 022 735 873	16:10	0,9	Not included	1 year
90"	7 350 022 735 880	16:10	0,9	Not included	1 year
100"	7 350 022 735 897	16:10	0,9	Not included	1 year
108"	7 350 022 735 903	16:10	0,9	Not included	1 year
120"	7 350 022 735 910	16:10	0,9	Not included	1 year
135"	7 350 022 735 927	16:10	0,9	Not included	1 year
150"	7 350 022 735 934	16:10	0,9	Not included	1 year
162"	7 350 022 735 941	16:10	0,9	Not included	1 year
180"	7 350 022 735 958	16:10	0,9	Not included	1 year
226"	7 350 022 735 965	16:10	0,9	Not included	1 year

## 16:9

Size:	Article Nr:	Format:	Gain:	Frame:	Warranty:
77"	7 350 022 734 708	16:9	0,9	Not included	1 year
90"	7 350 022 734 715	16:9	0,9	Not included	1 year
100"	7 350 022 734 722	16:9	0,9	Not included	1 year
108"	7 350 022 734 739	16:9	0,9	Not included	1 year
120"	7 350 022 734 746	16:9	0,9	Not included	1 year
135"	7 350 022 734 753	16:9	0,9	Not included	1 year
150"	7 350 022 734 760	16:9	0,9	Not included	1 year
162"	7 350 022 734 777	16:9	0,9	Not included	1 year
180"	7 350 022 734 784	16:9	0,9	Not included	1 year
226"	7 350 022 734 791	16:9	0,9	Not included	1 year

## 2.35:1

Size:	Article Nr:	Format:	Gain:	Frame:	Warranty:
84"	7 350 022 734 807	2.35:1	0,9	Not included	1 year
90"	7 350 022 734 814	2.35:1	0,9	Not included	1 year
100"	7 350 022 734 821	2.35:1	0,9	Not included	1 year
108"	7 350 022 734 838	2.35:1	0,9	Not included	1 year
120"	7 350 022 734 845	2.35:1	0,9	Not included	1 year
135"	7 350 022 734 852	2.35:1	0,9	Not included	1 year
150"	7 350 022 734 869	2.35:1	0,9	Not included	1 year
162"	7 350 022 734 876	2.35:1	0,9	Not included	1 year
180"	7 350 022 734 883	2.35:1	0,9	Not included	1 year
200"	7 350 022 734 890	2.35:1	0,9	Not included	1 year



- Multi-layer PVC (Polyvinyl chloride) with texture and surface coating
- Surface can be cleaned with mild soap and water
- Exceptional picture quality

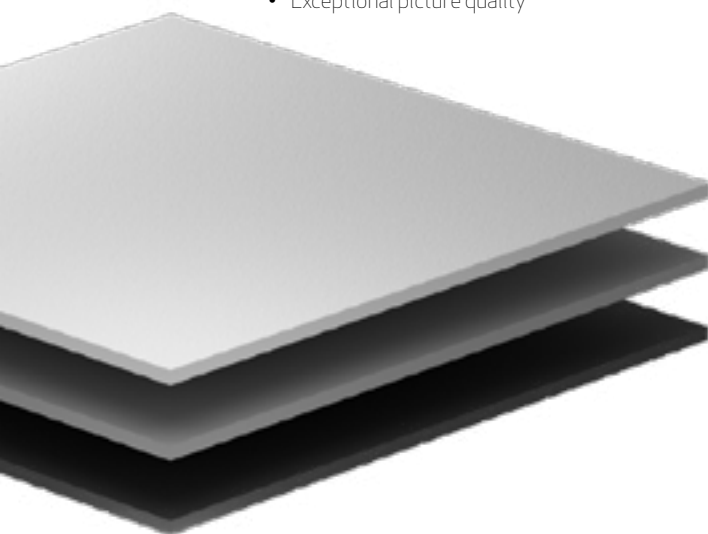



## Mission

Le Screen's mission is to make High-end Quality Projection Screens available to every budget without compromising the product quality.

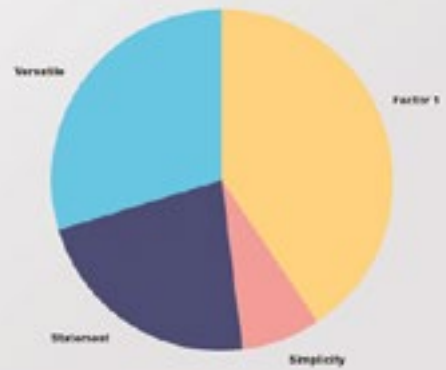



**PORTABLE PROJECTION  
SCREENS**

# M PORTABLE PROJECTION SCREEN EXTREMELY LIGHTWEIGHT AND PORTABLE

## SUITABLE FOR PROFESSIONAL USE FOR PEOPLE ON THE GO

Our portable projection screens are designed to be easy to bring along. The screen unfolds with a scissor like structure, making it easy to use in cramped up places. These screens are easy to use, lightweight and truly portable. Perfect if you are on the go.

## PORTABLE PROJECTION SCREENS

- The flexible tensioning arms makes it possible for the screen to unfold with precision and quality
- The M Portable Projection screen has two rotatable feet ensuring stability
- An extra strong case makes the unit handle travelling with ease
- Available with aspect ratios 16:9, 16:10, 4:3 and 1:1
- Available from 54" to 100"

## SET UP AS EASY AS 1-2-3





High Quality 3-Layer Screen Cloth  
anti-wrinkle and tear resistant



Cleanable Screen Material  
for easy maintenance



Flexible Tensioning Arms  
make it possible for the screen to unfold  
with precision and quality



Aluminum Case with Built-in Carrying Handle  
for safe and convenient transport



Locking Latches  
for added safety during transport



Rotable Feet  
for stability



1:1      4:3      16:9      16:10

Multiple Aspect Ratios

M 1:1 Portable Projection Screen



Size:	Article Nr:	Projection Area:	Diagonal	Colour:	Surface:	Gain:	Border:	Wieght:	Single package measurements:	Warranty:
54"	7 350 022 731 974	100 x 100 cm	137 cm	Black	Matte white	1,0	3 cm	9 kg	185,4 x 9 x 9 cm	1 year
67"	7 350 022 731 790	120 x 120 cm	170 cm	Black	Matte white	1,0	3 cm	12 kg	213,4 x 9 x 9 cm	1 year
80"	7 350 022 731 806	145 x 145 cm	203 cm	Black	Matte white	1,0	3 cm	13 kg	255,4 x 9 x 9 cm	1 year

M 4:3 Portable Projection Screen



Size:	Article Nr:	Projection Area:	Diagonal	Colour:	Surface:	Gain:	Border:	Wieght:	Single package measurements:	Warranty:
60"	7 350 022 730 632	120 x 90 cm	152 cm	Black	Matte white	1,0	3 cm	12 kg	140 x 17 x 17 cm	1 year
86"	7 350 022 731 851	172 x 130 cm	218 cm	Black	Matte white	1,0	3 cm	15 kg	192 x 17 x 17 cm	1 year
100"	7 350 022 731 868	200 x 150 cm	254 cm	Black	Matte white	1,0	3 cm	16 kg	220 x 17 x 17 cm	1 year

M 16:9 Portable Projection Screen



Size:	Article Nr:	Projection Area:	Diagonal	Colour:	Surface:	Gain:	Border:	Wieght:	Single package measurements:	Warranty:
54"	7 350 022 730 625	120 x 67 cm	137 cm	Black	Matte white	1,0	3 cm	11 kg	140 x 17 x 17 cm	1 year
77"	7 350 022 731 820	172 x 97 cm	196 cm	Black	Matte white	1,0	3 cm	14 kg	192 x 17 x 17 cm	1 year
90"	7 350 022 731 837	200 x 112 cm	229 cm	Black	Matte white	1,0	3 cm	16 kg	219 x 17 x 17 cm	1 year

M 16:10 Portable Projection Screen



Size:	Article Nr:	Projection Area:	Diagonal	Colour:	Surface:	Gain:	Border:	Wieght:	Single package measurements:	Warranty:
54"	7 350 022 735 699	116,3x72,7 cm	137,2 cm	Black	Matte white	1,0	3 cm	12 kg	140 x 17 x 17 cm	1 year
77"	7 350 022 735 712	165,9x103,7 cm	195,6 cm	Black	Matte white	1,0	3 cm	15 kg	187 x 17 x 17 cm	1 year
90"	7 350 022 735 729	193,9x121,2 cm	228,7 cm	Black	Matte white	1,0	3 cm	17 kg	215 x 17 x 17 cm	1 year



ISE Barcelona  
**SHOW**

The largest show in  
the AV industry.

**WELC**  
TO OUR  
**COMI**



A man in a light-colored shirt and dark pants stands on a stage, pointing towards a large projection screen. The screen displays a modern building facade with the text 'WELCOME TO COMPANY' overlaid. The audience is visible in the foreground, and the background is a dark, textured wall.

WELCOME  
TO  
COMPANY

**QUICK FOLD  
PROJECTION SCREENS**

# QUICK FOLD PROJECTION SCREENS

## EASY TO TRANSPORT BETWEEN DIFFERENT LOCATIONS

Le Screen Quick Fold Projection Screens are elegant projection screens designed for flexibility and easy transport. The perfect choice if you are looking for a flexible projection screen solution. It is easy to move between rooms and easy to transport between different locations.

Suited for commercial presentations, residential home cinemas, sport bars etc. This is ideal for both indoor and outdoor presentations. It only takes minutes to install and assemble. Flight case design makes it convenient for you to carry it with you and aluminum frame case helps to enhance screen surface tension. Wide selections of sizes are provided to meet your diverse needs.

Aspect Ratios:

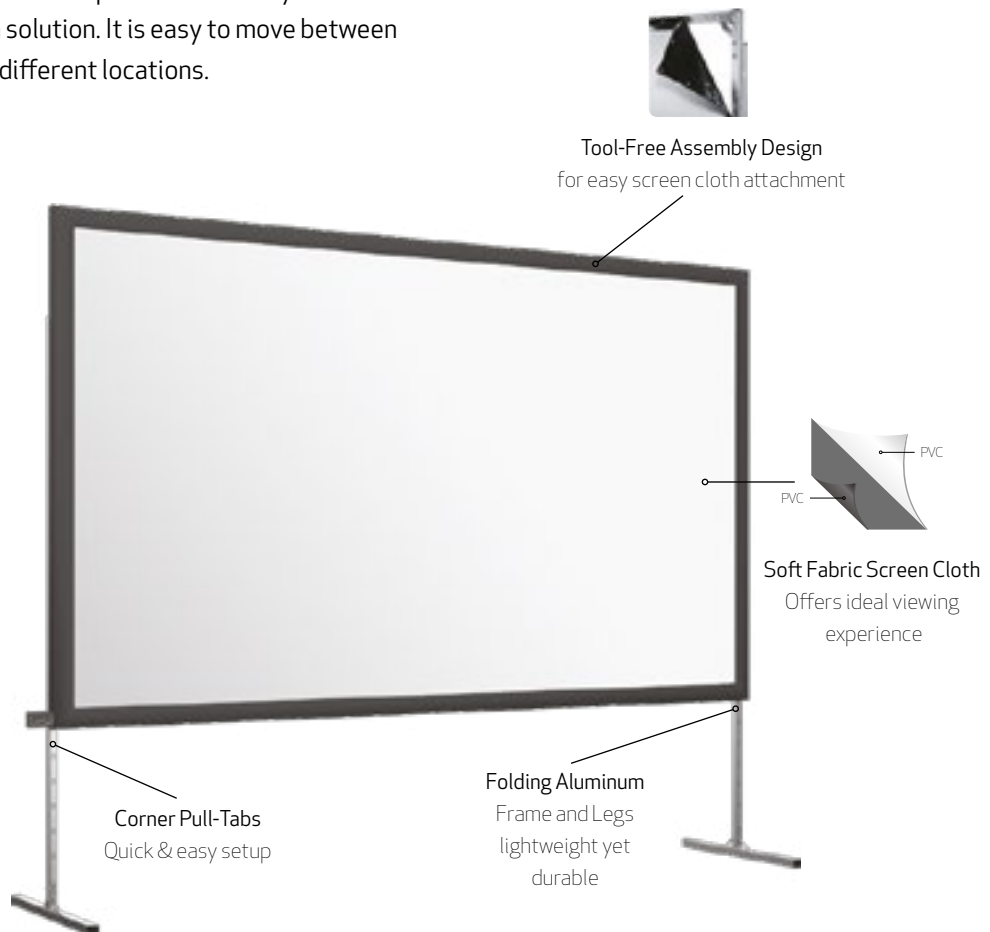
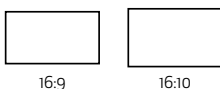

## QUICK FOLD PROJECTION SCREENS

- Offering a clear picture with 140° viewing angle
- Ensures toolless height adjustment with Locking Rotary Knob
- Tool-Free Assembly Design: allows set-up in minutes by simply unfolding and locking frame, snapping on projection material and inserting legs
- Enhance picture contrast with the 4-sides black Masking Borders
- 1.1 Gain: Help you enjoy vibrant images through preventing light from muddying the colors on the screen
- Aluminum Flight Case: Ideal for travel and protects the screen when not in use
- Available in 16:9 and 16:10 aspect ratios



Rugged Flight Case with Rotating Clasps and Wheels  
Ideal for storage and transport

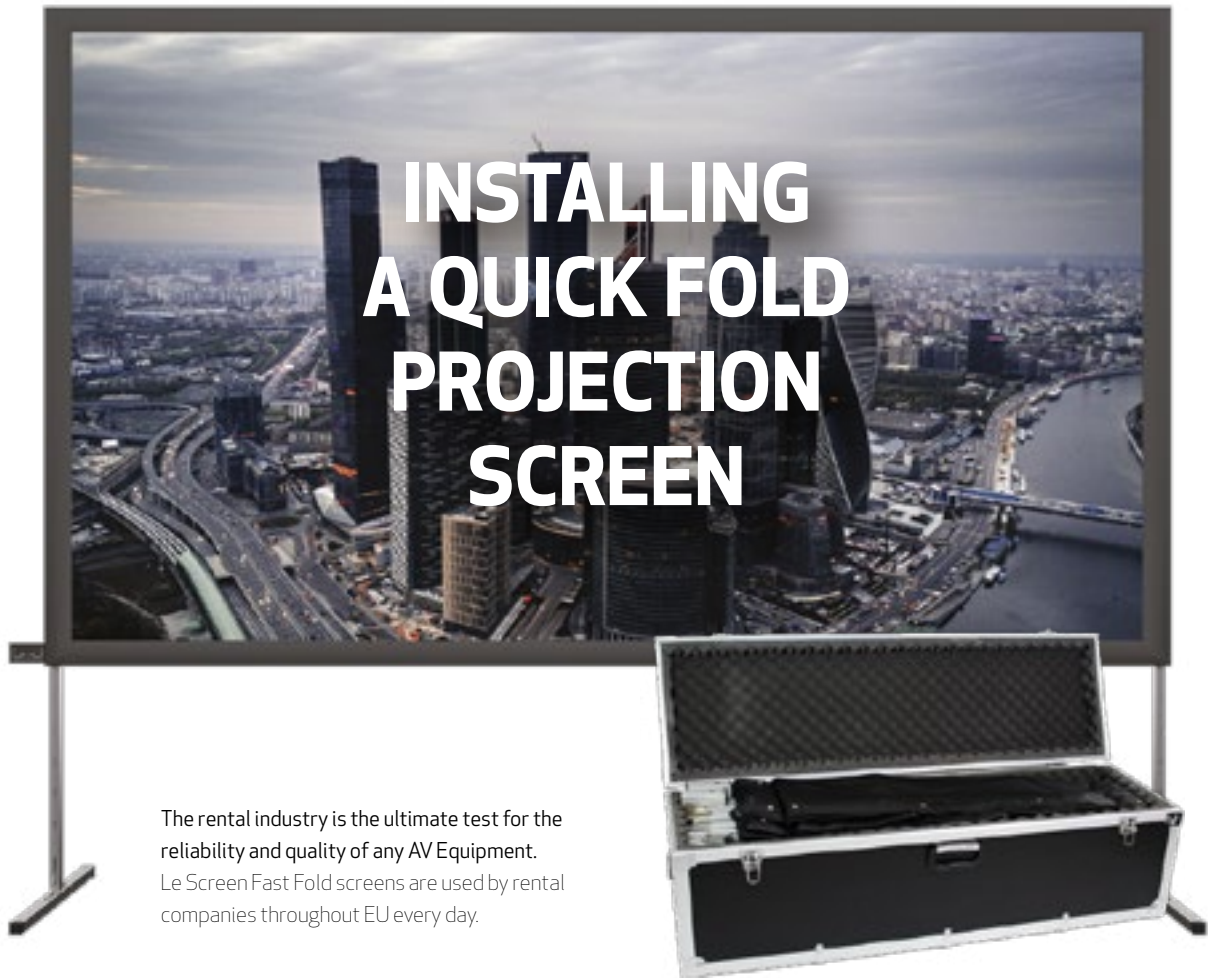

The rental industry is the ultimate test for the reliability and quality of any AV Equipment. Le Screen Fast Fold screens are used by rental companies throughout EU every day.



M Quick Fold  
Projection Screen 16:9  
120" to 180"

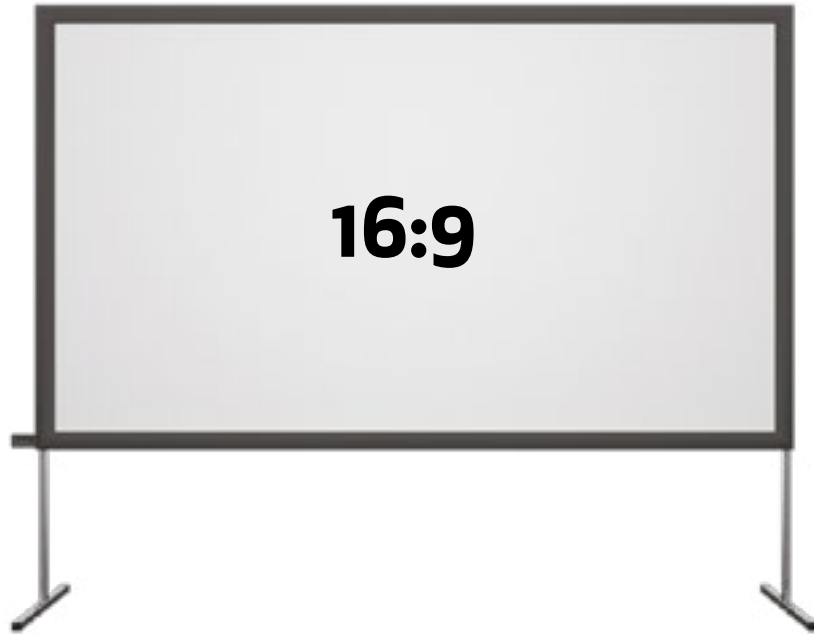

Size:	Article Nr:	Projection Area:	Diagonal	Frame colour:	Surface:	Gain:	Frame:	Wieght:	Single package measurements:	Warranty:
120"	7 350 073 731 916	265 x 149 cm	304 cm	Black	Matte white	1,0	7 cm	25 kg	185 x 22 x 14 cm	1 year
150"	7 350 073 731 923	332 x 187 cm	381 cm	Black	Matte white	1,0	7 cm	29 kg	212 x 22 x 14 cm	1 year
180"	7 350 073 731 930	400 x 225 cm	458,9 cm	Black	Matte white	1,0	7 cm	44 kg	234 x 22 x 14 cm	1 year

M Quick Fold  
Projection Screen 16:9  
200" to 300"

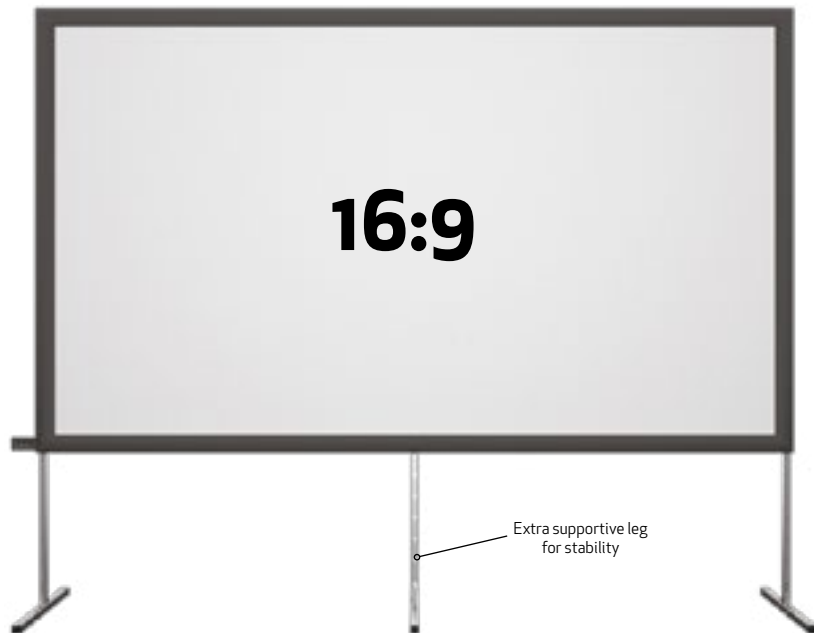

Size:	Article Nr:	Projection Area:	Diagonal	Frame colour:	Surface:	Gain:	Frame:	Wieght:	Single package measurements:	Warranty:
200"	7 350 073 731 947	443 x 249 cm	508.2 cm	Black	Matte white	1,0	7 cm	51 kg	2,33 x 1,62 m	1 year
250"	7 350 073 731 954	554 x 312 cm	635,8 cm	Black	Matte white	1,0	7 cm	66 kg	2,59 x 1,62 m	1 year
300"	7 350 073 731 961	664 x 374 cm	762.1 cm	Black	Matte white	1,0	7 cm	95 kg	2,91 x 1,82 m	1 year

M Quick Fold  
Projection Screen 16:10  
120" to 180"

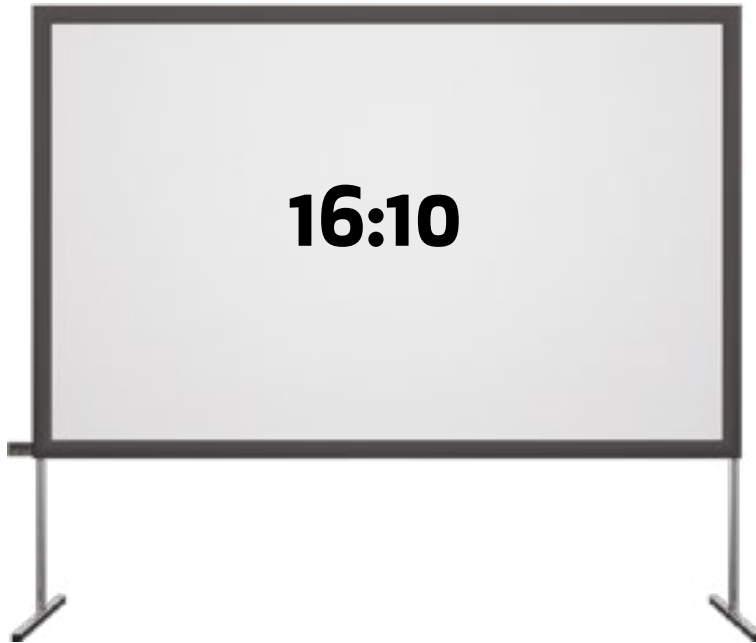

Size:	Article Nr:	Projection Area:	Diagonal	Frame colour:	Surface:	Gain:	Frame:	Wieght:	Single package measurements:	Warranty:
120"	7350 073 731 978	258 x 161 cm	304.1 cm	Black	Matte white	1,0	7 cm	26 kg	116 x 34 x 34 cm	1 year
150"	7350 073 731 985	323 x 202 cm	380.9 cm	Black	Matte white	1,0	7 cm	31 kg	138 x 37 x 37 cm	1 year
180"	7350 073 731 992	388 x 242 cm	457.3 cm	Black	Matte white	1,0	7 cm	47 kg	106 x 42 x 42 cm	1 year

M Quick Fold  
Projection Screen 16:10  
200" to 300"

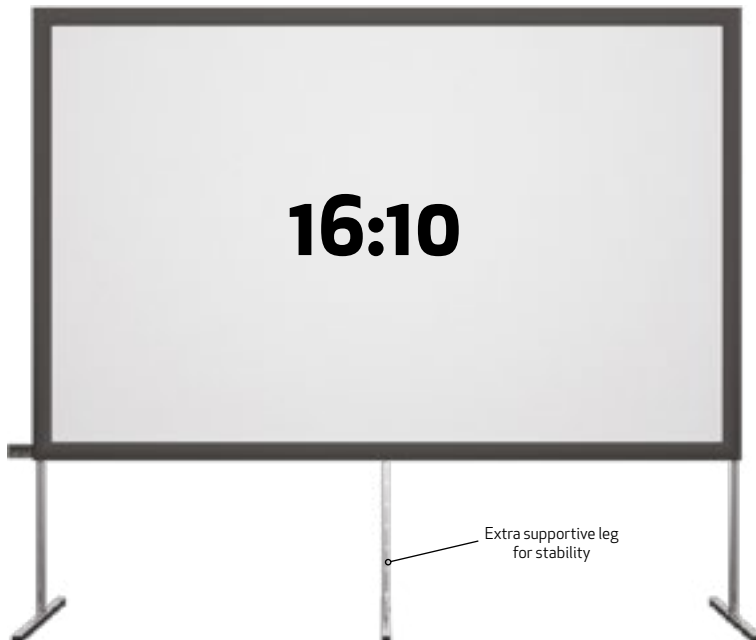

Size:	Article Nr:	Projection Area:	Diagonal	Frame colour:	Surface:	Gain:	Frame:	Wieght:	Single package measurements:	Warranty:
200"	7350 073 732 005	431 x 269 cm	508.1 cm	Black	Matte white	1,0	7 cm	53 kg	140 x 17 x 17 cm	1 year
250"	7350 073 732 012	538 x 336 cm	634.3 cm	Black	Matte white	1,0	7 cm	69 kg	138 x 47 x 47 cm	1 year
300"	7350 073 732 029	646 x 404 cm	761.9 cm	Black	Matte white	1,0	7 cm	100 kg	158 x 44 x 44 cm	1 year

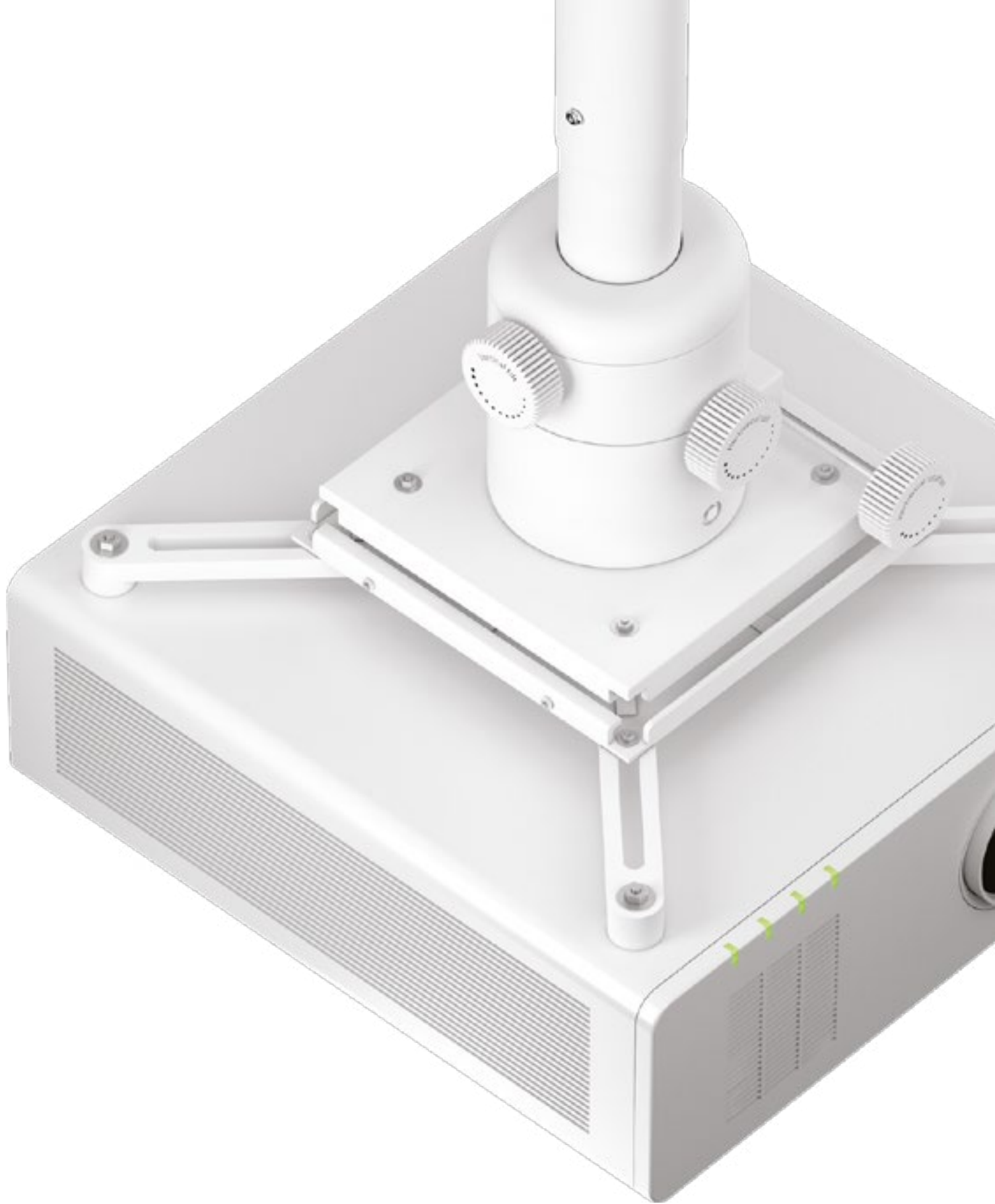

**CHOOSE THE RIGHT MOUNT  
FOR YOUR PROJECTOR:**

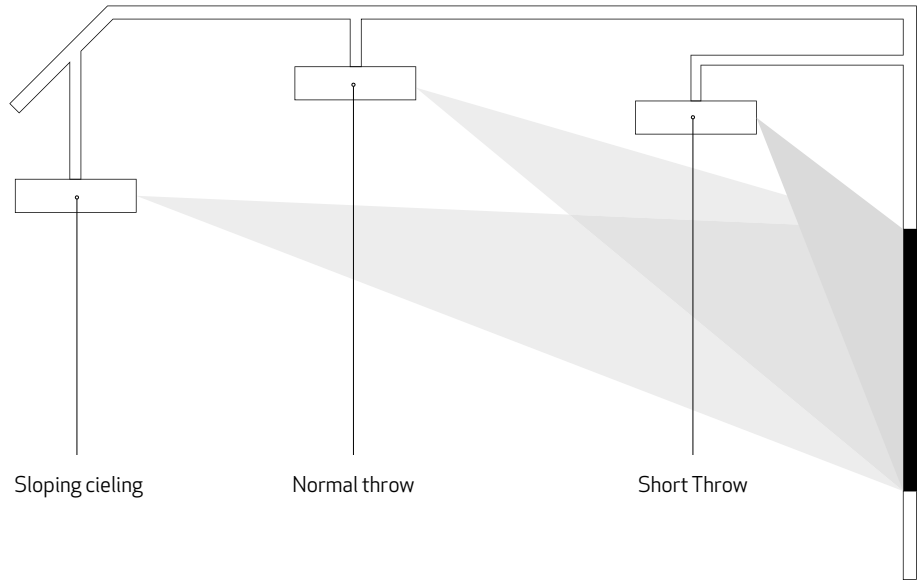

**PROJECTOR  
CEILING MOUNTS**

# PROJECTOR CEILING MOUNTS

## INDUSTRY-LEADING PROJECTOR MOUNTS WITH FINE TUNE TECHNOLOGY FOR CEILING INSTALLATIONS.

Le Screen Projector Ceiling Mount series 200/ 500-800/ 600-1000/ 900-1600/ 1600-3000 with Fine tune offers an industry-leading projector mount for ceiling installations. The series minimizes installation time, simplify maintenance and offers a sought after fine tune adjustment alignment with 3-axle angles. This model also offers an anti-theft security feature.

The M Universal Projector Ceiling Mount 200 with Fine tune give you easy placement of your projector in the most discreet setting possible. You can orient and incline according to several axes. The model features integrated cable management, easy fine tune settings adjustments, once the projector is in place. This projector mount has a minimum of surface area to the projector good for not trapping heat close to your projector thus not cutting your projector lamps lifetime.

The built in fine tune technology provides easy fingertip positioning capabilities which automatically adjusts the projectors position. That way you can always be sure to get a well balanced position for your projector after installing it. This does not only save installation time but also make room for possible changes of what projector is being used or how your projection screen is positioned, perfect if you anticipate changing projectors in the future. The arms holding the projector are articulated and telescopic to adopt to almost all projector models.

Le Screen Projector Ceiling Mount series 200/ 500-800/ 600-1000/ 900-1600/ 1600-3000 with Fine tune offers an industry-leading projector mount for ceiling installations. The series minimizes installation time, simplify maintenance and offers a sought after fine tune adjustment alignment with 3-axle angles. This model also offers an anti-theft security feature.

There is a reason why this series of projector mounts quickly has become one of Le Screen top selling product lines.

### HIGHLIGHTS:

- Fast installation with innovative design
- Ideal for those who wish to use it with more than one brand projectors, or who anticipate changing projectors in the future
- Projector position from the ceiling
- Integrated lateral shift
- Telescopic slide extension
- Fine tune adjustment alignment with 3-axle angle
- Integrated cable management system for concealing cables
- Product: Includes arm and projector mount (complete)
- Ceiling: Includes hardware for a complete installation for nearly any ceiling
- For faster installation the unit comes partially pre assembled





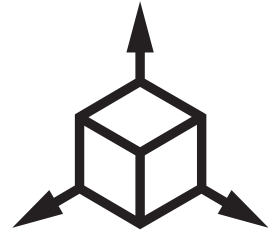
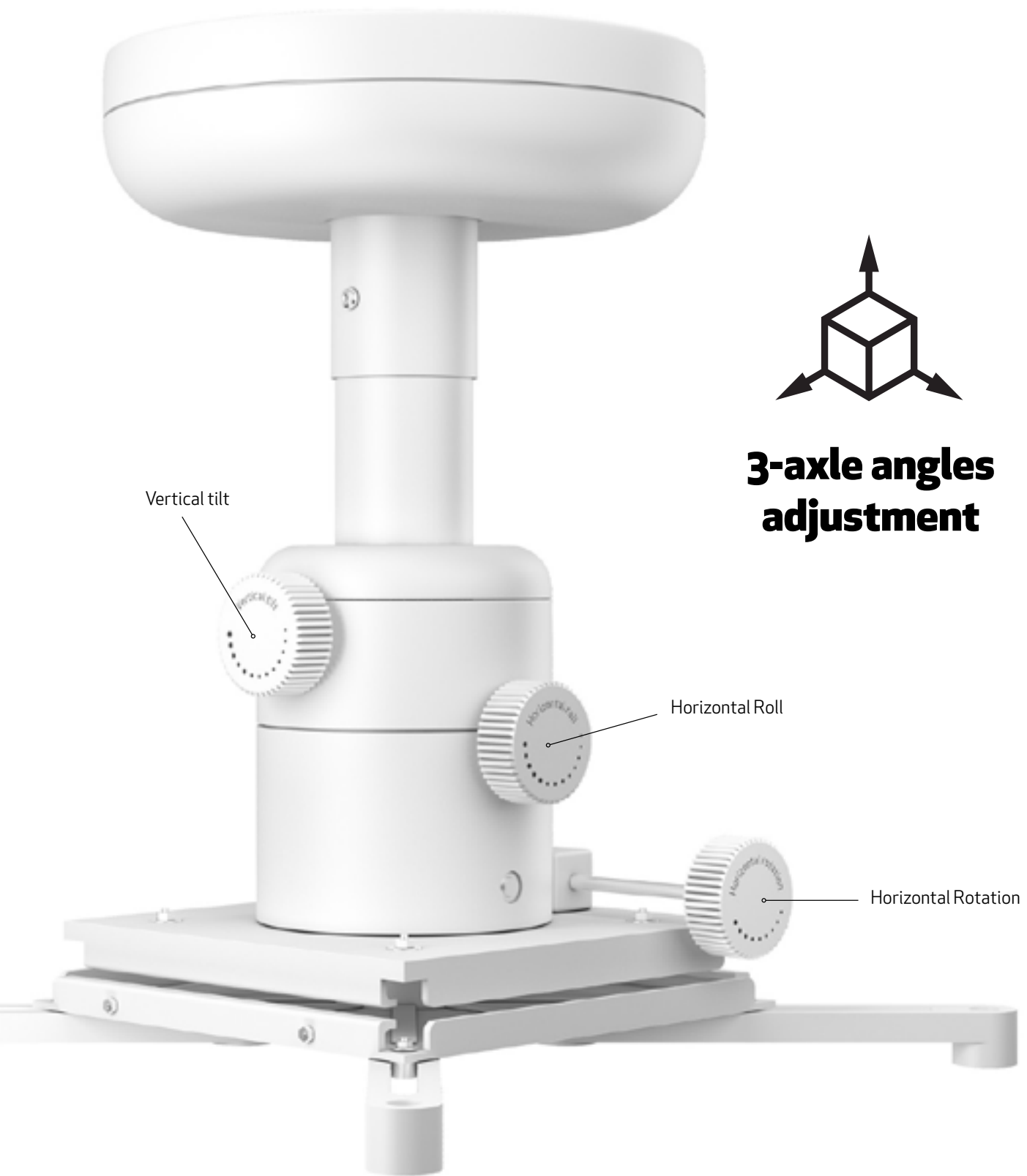

## 3-axe angles adjustment

Vertical tilt

Horizontal Roll

Horizontal Rotation

# PRO M Universal Projector Ceiling Mount with Fine tune

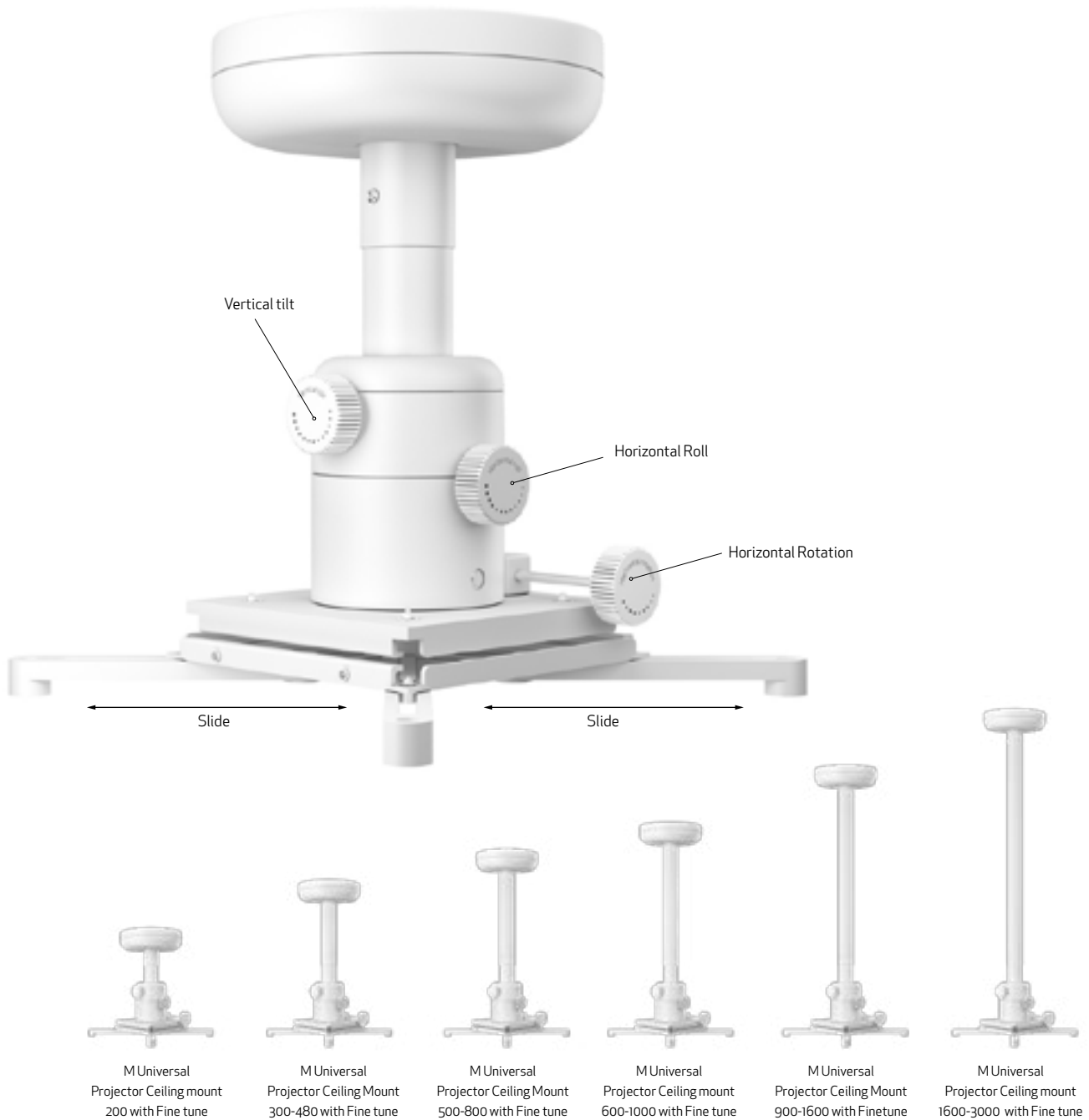

<b>Article No:</b>	7 350 073 730 728	7 350 073 733 149	7 350 073 731 770	7 350 073 730 735	7 350 073 731 787	7 350 073 730 742
<b>Height:</b>	200 mm	300 - 480 mm	500 - 800 mm	600 - 1000 mm	900 - 1600 mm	1600 - 3000 mm
<b>Vertical tilt:</b>	±5°	±5°	±5°	±5°	±5°	±5°
<b>Horizontal roll:</b>	±5°	±5°	±5°	±5°	±5°	±5°
<b>Horizontal rotation:</b>	±5°	±5°	±5°	±5°	±5°	±5°
<b>Dist. from ceiling:</b>	200 mm	300 - 480 mm	500 - 800 mm	600 - 1000 mm	900 - 1600 mm	1600 - 3000 mm
<b>Weight:</b>	2,1kg	2 kg	2.4kg	2.4 kg	2.4 kg	3.3kg
<b>Colour:</b>	White	White	White	White	White	White
<b>Max load ceiling / wall:</b>	15kg	15kg	10kg	10kg	10 kg	10 kg
<b>Warranty:</b>	5 years	5 years	5 years	5 years	5 years	5 years

# HEAVY DUTY M Projector Mount HD



Sloping ceiling mount included



M Projector Mount HD  
305-345mm

M Projector Mount HD  
620-800mm

M Projector Mount HD  
970-1500mm

M Extension Poles  
Projector Mount HD  
2x 950mm

M Cable Management  
Projector Mount HD

M Projector Mount HD  
Cage

Padlock:  
optional

<b>Article No:</b>	7 350 073 735 211	7 350 073 735 228	7 350 073 735 235	7 350 073 735 242	7 350 073 737 383	7 350 073 735 259
<b>Height:</b>	305-345 mm	620-800mm	970-1500 mm	950 mm	125 mm (Diameter: 50/54 mm)	Inner cage size: 482x402x198mm
<b>Dist. from ceiling min.:</b>	305 mm	620 mm	970 mm	-	-	-
<b>Dist. from wall min.:</b>	335mm	650mm	1000mm	-	-	-
<b>Tilt:</b>	+/-20°	+/-20°	+/-20°	-	-	-
<b>Weight:</b>	2 kg	2 kg	2 kg	2 kg	0.1 kg	6.5 kg
<b>Colour:</b>	White	White	White	White	White	White
<b>Max load ceiling / wall:</b>	30 kg	30 kg	30 kg	30 kg	-	30 kg
<b>Rotate:</b>	360°	360°	360°	-	-	-
<b>Warranty:</b>	5 years	5 years	5 years	5 years	5 years	5 years

# BASIC M Universal Projector Ceilingmount



M Universal  
Projector Ceilingmount I



M Universal  
Projector Ceilingmount III  
180 or 430mm



M Universal  
Projector Ceilingmount III  
400-1700mm

<b>Article No:</b>	7 350 022 730 311	7 350 022 731 011	7 350 022 732 544
<b>Height:</b>	150 mm or 430-630 mm	180 mm or 430 mm	400-1700 mm
<b>Dist. from ceiling minimum:</b>	150 mm	180 mm	150 mm
<b>Dist. from wall minimum:</b>	-	430 mm	-
<b>Tilt:</b>	Yes	Yes +/-30°	Yes +/-30°
<b>Weight:</b>	2 kg	2 kg	3 kg
<b>Colour:</b>	White	White	White
<b>Max load ceiling / wall:</b>	5 kg	10 / 7,5 kg	10 kg
<b>Rotate:</b>	360°	360°	360°
<b>Warranty:</b>	5 years	5 years	5 years







**BEKAFUN**

Heilig Hartstraat 23 B-8870 Izegem | [info@bekafun.be](mailto:info@bekafun.be) | 051 31 28 03  
Open: ma-vr 9u-18u | za 10u-17u